

CHAPTER

1

Analogy

DIRECTIONS (Qs. 1-8) : In each of the following questions, select the related letters/word/number from the given alternatives.

(SSC CGL 1st Sit. 2010)

- ACEG : BDFH :: SUWY : ?
(a) TVZX (b) RTZV
(c) TVXZ (d) RTVZ
- $\frac{M}{AC} : \frac{N}{AD} :: \frac{O}{AE} : ?$
(a) $\frac{P}{AF}$ (b) $\frac{Q}{AB}$ (c) $\frac{P}{AC}$ (d) $\frac{R}{AD}$
- 5 : 27 :: 9 : ?
(a) 83 (b) 81 (c) 36 (d) 18
- 6 : 11 :: 11 : ?
(a) 6 (b) 17 (c) 21 (d) 30
- ABE : 8 :: KLO : ?
(a) 37 (b) 39 (c) 38 (d) 36
- Sty : Pig :: Byre : ?
(a) Eagle (b) Cow
(c) Tiger (d) Hen
- Patrol : Security :: Insurance : ?
(a) Money (b) Policy
(c) Savings (d) Risk
- ADBC : EHFG :: ILJK : ?
(a) MOPN (b) MPNO
(c) ORPQ (d) MPON
- Find out a set of numbers amongst the four sets of numbers given in the alternatives, which is the most similar to the numbers given in the question. (SSC CGL 1st Sit. 2010)
Given : (6, 30, 90)
(a) 6, 42, 86 (b) 7, 42, 218
(c) 6, 24, 70 (d) 8, 48, 192
- AZCX : BYDW :: HQJO : ?
(a) GRFP (b) IPKM
(c) IPKN (d) GRJP
- QIOK : MMKO :: YAWC : ?
(a) USGA (b) UESG
(c) VUES (d) SUEG
- $\frac{ABC}{F} : \frac{BCD}{I} :: \frac{CDE}{L} : ?$
(a) $\frac{DEF}{O}$ (b) $\frac{DEF}{N}$
(c) $\frac{EDF}{O}$ (d) $\frac{DEF}{M}$
- 1 : 8 :: 27 : ?
(a) 37 (b) 47
(c) 57 (d) 64
- 24 : 126 :: 48 : ?
(a) 433 (b) 192
(c) 240 (d) 344
- 987 : IHG :: 654 : ?
(a) FDE (b) FED
(c) EFD (d) DEF
- From amongst the given alternatives, select the one in which the set of numbers is most like the set of numbers given below : (SSC CGL 2nd Sit. 2010)
(6, 14, 30)
(a) 4, 16, 28 (b) 7, 12, 22
(c) 6, 12, 22 (d) 5, 12, 20

DIRECTIONS (Qs. 19-27) : In each of the following questions, select the related letters/word/numbers from the given alternatives.

(SSC CGL 1st Sit. 2011)

DIRECTIONS (10-17) : In each of the following questions, select the related word/letters/ number from the given alternatives.

(SSC CGL 1st Sit. 2010)

- Fox : Cunning :: Rabbit : ?
(a) Courageous (b) Dangerous
(c) Timid (d) Ferocious
- Flexible : Rigid :: Confidence : ?
(a) Diffidence (b) Indifference
(c) Cowardice (d) Scare
- Fish : Scales :: Bear : ?
(a) Feathers (b) Leaves
(c) Fur (d) Skin
- Writer : Pen :: ?
(a) Needle : Tailor (b) Artist : Brush
(c) Painter : Canvas (d) Teacher : Class
- NUMERAL : UEALRMN :: ALGEBRA : ?
(a) LRBAGEA (b) BARLAGE
(c) LERAGBA (d) LERABGA
- BDAC : FHEG :: NPMO : ?
(a) RQTS (b) QTRC
(c) TRQS (d) RTQS

23. FGHI : OPQR : BCDE : ?
 (a) KLMJ (b) KLMN
 (c) IUVW (d) STUW
24. PNLJ : IGEC : : VTRP : ?
 (a) OMKI (b) RSTU
 (c) QSRC (d) RPOM
25. 17 : 60 : : 20 : ?
 (a) 57 (b) 69
 (c) 81 (d) 93
26. 6 : 64 : : 11 : ?
 (a) 144 (b) 169
 (c) 121 (d) 124
27. 123 : 4 : : 726 : ?
 (a) 23 (b) 26
 (c) 14 (d) 12

DIRECTIONS (Qs. 28-36): Select the related letter/word/number from the given alternatives.

(SSC CGL 2nd Sit. 2011)

28. Country : President : : State : ?
 (a) Chief Minister (b) Prime Minister
 (c) Speaker (d) Governor
29. Mirage : Desert : : ?
 (a) Sky : Illusion (b) Rainbow : Sky
 (c) Rain : Rainbow (d) Image : Mirror
30. TEKCAR : RACKET : : TCEJBO : ?
 (a) TCEOBJ (b) OBJECT
 (c) CEJBOT (d) REJECT
31. JIHK : PONQ : : WVUX : ?
 (a) KNML (b) RSTU
 (c) HIGJ (d) MLKN
32. UUWX : WWYZ : : OOQR : ?
 (a) OOPG (b) MMPQ
 (c) XXYZ (d) QQST
33. BIMN : CKPR : : CURD : ?
 (a) DWUH (b) WUHC
 (c) UHDW (d) HUVN
34. BCFE : HILK : : NORQ : ?
 (a) TXWU (b) TXUW
 (c) TUXW (d) TUWX
36. 64 : ? : : 72 : 53
 (a) 44 (b) 54
 (c) 52 (d) 70
37. Find out the questioned number. (SSC CGL 2nd Sit. 2011)
 6 : 5 : : 8 : ?
 (a) 2 (b) 4
 (c) 6 (d) 10

DIRECTIONS (Qs. 38-44): Select the related word/letters from the given alternatives.

(SSC Sub. Ins. 2012)

38. Blue whale : Sea : : ? : Land
 (a) Turtle (b) Fish
 (c) Elephant (d) Green whale

39. Anaemia : Blood : : Anarchy : ?
 (a) Disorder (b) Monarchy
 (c) Government (d) Lawlessness
40. Hard : Rock : : Soft : ?
 (a) Lead (b) Paper
 (c) Sponge (d) Glass
41. DHLP : BDFH : : FLRX : ?
 (a) CFHL (b) CFIL
 (c) FHLK (d) HLKM
42. DIMP : CJLQ : : UWZA : ?
 (a) XTYB (b) TXBY
 (c) XTBY (d) TXYB
43. ABDH : CFHP : : JKMQ : ?
 (a) LOSY (b) KOQY
 (c) KPQR (d) LOQY
44. IJKL : STUV : : MNOP : ?
 (a) PQRS (b) RSTU
 (c) VWXY (d) WXYZ
45. Among the four sets, find out the set, which is like the given set.
 Given set : (12, 72, 216) (SSC Sub. Ins. 2012)
 (a) (4, 24, 48) (b) (7, 42, 252)
 (c) (11, 60, 30) (d) (5, 30, 90)

DIRECTIONS (Qs. 46 - 51): Select the related letter/word/number from the given alternatives.

(SSC CHSL 2012)

46. Symphony : Composer : : Painter : ?
 (a) Fresco (b) Colours
 (c) Art (d) Leonardo
47. Elephant : Tusk : : Parrot : ?
 (a) Quill (b) Feather
 (c) Beak (d) Spine
48. 27 : 125 : : 64 : ?
 (a) 162 (b) 216
 (c) 273 (d) 517
49. AB : L : : BC : ?
 (a) X (b) V
 (c) Y (d) W
50. BDGJ : OQTW : : AFIM : ?
 (a) 64 (b) 79
 (c) 18 (d) 81

DIRECTIONS (Qs. 52-60): Select the related letters/word number from the given alternatives.

(SSC CGL 1st Sit. 2012)

52. 8 : 12 : : 6 : ?
 (a) 8 (b) 11
 (c) 5 (d) 7
53. 13 : 19 : : 21 : ?
 (a) 41 (b) 81
 (c) 141 (d) 14
54. Eagle : Swoops : : Duck : ?
 (a) waddles (b) floats
 (c) swims (d) flits

55. APPLE : 50 :: ORANGE : ?
 (a) 60 (b) 69
 (c) 61 (d) 63
56. Accommodation : Rent :: Journey : ?
 (a) Freight (b) Octroi
 (c) Fare (d) Expense
57. Fire : Smoke :: ?
 (a) Children : School (b) Cloud : Rain
 (c) Moon : Sky (d) Shoe : Polish
58. Grenade : Gun :: ?
 (a) Sister : Brother (b) Father : Mother
 (c) Man : Woman (d) Head : Brain
59. TSH : IRQ :: QPK : ?
 (a) LNO (b) LON
 (c) PWK (d) PON
60. AEZ : FPY :: BGX : ?
 (a) HWW (b) IYY
 (c) HTX (d) HYW

DIRECTIONS (Qs. 61-69): Select the related letter/word/number from the given alternatives:

(SSC CGL 1st Sit. 2012)

61. Zoology : Animal :: Psychology : ?
 (a) Animal
 (b) Human-being
 (c) Animal and human-being
 (d) Plant
62. CFIL : ABCD :: ? : WXYZ
 (a) ZYXW (b) YBEH
 (c) JHPS (d) XURO
63. L × M : 12 × 13 :: U × W : ?
 (a) 21 × 23 (b) 24 × 26
 (c) 9 × 11 (d) 12 × 23
64. Man : Mammal :: ?
 (a) Liberty : Literate (b) Hail : Snow
 (c) Native : Inhabitant (d) Offspring : Family
65. 6 : 2 :: 8 : ?
 (a) 5 (b) 1
 (c) 3 (d) 7
66. CFIL : XURO :: ORUX : ?
 (a) MJFC (b) ROLI
 (c) RITO (d) LIFC
67. 1 : 8 :: 4 : ?
 (a) 32 (b) 64
 (c) 512 (d) 128
68. Life starts : Embryo :: Life ends : ?
 (a) Death (b) Old age
 (c) Dead body (d) Illness
69. EVFU : TGSH :: IRJQ : ?
 (a) PKLO (b) KWLX
 (c) PKOL (d) OLPK

DIRECTIONS (Qs. 70-78): In each of the following questions, select the related letter/word/number from the given alternatives.

(SSC CGL 2nd Sit. 2012)

70. 9 : 80 :: 100 : ?
 (a) 901 (b) 1009
 (c) 9889 (d) 9999

71. 25 : 125 :: 36 : ?
 (a) 180 (b) 206
 (c) 216 (d) 318
72. 335 : 216 : 987 : ?
 (a) 868 (b) 867
 (c) 872 (d) 888
73. BEGK : ADFJ :: PSVY : ?
 (a) ROUX (b) ORUX
 (c) LQUT (d) LOQT
74. AZBY : CXDW :: EVFU : ?
 (a) GTHS (b) GHTS
 (c) GSTH (d) TGSH
75. BDFH : SUWY :: CEGI : ?
 (a) QTWZ (b) PTVX
 (c) JLNP (d) TVXZ
76. food : man :: fuel : ?
 (a) wood (b) fire
 (c) heat (d) smoke
77. Spiritual : Belief :: Orchestral : ?
 (a) Theatre (b) Situation
 (c) Music (d) Direction
78. Latter : Former :: Hazardous : ?
 (a) Risky (b) Comfortable
 (c) Safe (d) Harmful

DIRECTIONS (Qs. 79 - 87) : Select the related letter / word / number from the given alternatives.

(SSC CGL 2nd Sit. 2012)

79. Length : Metre :: Power : ?
 (a) Calories (b) Degree
 (c) Watt (d) Kilogram
80. Square : Cube :: Circle : ?
 (a) Ellipse (b) Parabola
 (c) Cone (d) Sphere
81. Paper : Tree :: Glass : ?
 (a) Window (b) Sand
 (c) Stone (d) Mirror
82. ACFJ : ZXUQ :: EGIN : ?
 (a) VUSQ (b) VRPM
 (c) UTRP (d) VTRM
83. ACEG : DFHJ :: QSUW : ?
 (a) TVXZ (b) TQST
 (c) MNPR (d) EGLJ
84. EGIK : FILO :: FHJL : ?
 (a) JGMP (b) JGPM
 (c) GJPM (d) GJMP
85. 10 : 91 :: 9 : ?
 (a) 69 (b) 72
 (c) 89 (d) 97
86. 7 : 56 :: 9 : ?
 (a) 63 (b) 81
 (c) 90 (d) 99
87. 20 : 50 :: 100 : ?
 (a) 150 (b) 250
 (c) 200 (d) 156

DIRECTIONS (Qs. 88-93): In each of the following questions, select the related word/ letter/ number from the given alternatives.

(SSC Sub. Ins. 2013)

88. ADHM : ZUQN :: GIKM : ?
 (a) NOQS (b) TQRN
 (c) TRPN (d) TNRP
89. 7 : 133 :: 9 : ?
 (a) 147 (b) 99
 (c) 171 (d) 158
90. 36 : 216 :: 81 : ?
 (a) 729 (b) 629
 (c) 319 (d) 826
91. Victory : Joy :: ? : Sorrow
 (a) Defeat (b) Depression
 (c) Melancholy (d) Cry
92. Body : Stomach :: Library : ?
 (a) Cash (b) Book
 (c) Headmaster (d) School
93. HAND : JBPE :: PALM : ?
 (a) RBNM (b) RBMN
 (c) QBNN (d) RBNN

DIRECTIONS (Qs. 94-95): Select the related letter/word/number from the given alternatives.

(SSC Multitasking 2013)

94. Astronomy : Stars :: Geology : ?
 (a) Sky (b) Geometry
 (c) Science (d) Earth
95. Up : Down :: Back : ?
 (a) Left (b) Deep
 (c) Front (d) Right

DIRECTIONS (Qs 96-103): Select the related word/letters/ number from the given alternatives.

(SSC CHSL 2013)

96. MOQS : ACEG :: PRTV : ?
 (a) KMNP (b) OQSU
 (c) EGIJ (d) FHJM
97. 36 : 144 :: 49 : ?
 (a) 196 (b) 154
 (c) 81 (d) 149
98. 76 : 42 :: 66 : ?
 (a) 36 (b) 63
 (c) 12 (d) 35
99. Picture : See :: Book : ?
 (a) Listen (b) Library
 (c) Buy (d) Read
100. Dark : Light :: ?
 (a) Ill : Diseased
 (b) Hot : Cold
 (c) Polluted : Contaminated
 (d) Accrued : Accumulated
101. Swimming : River :: Hiking : ?
 (a) Mountain (b) Sea
 (c) Road (d) Pond
102. HOPEFUL : LUFEPQH :: ETHNICITY : ?
 (a) ICINHTEYT (b) CINHTEYTI
 (c) YTCINHTE (d) TICINHTEY

103. Find out the set among the four sets which is like the given set.

(23 : 30 : 37)

(SSC CHSL 2013)

- (a) (21 : 28 : 34) (b) (12 : 19 : 25)
 (c) (6 : 13 : 20) (d) (7 : 15 : 22)

DIRECTIONS (Qs. 104-105): In the following questions, select the related letter/ word from the given alternatives.

(SSC CGL 1st Sit. 2013)

104. Horse : Neigh :: Bells : ?
 (a) Beat (b) Chime
 (c) Rustle (d) Roar
105. A - E : R - V :: B - F : F - J
 (a) CTDH (b) BSCG
 (c) FUGK (d) CSCG

DIRECTIONS (Qs. 106-111): In each of the following questions, select the related letters/word/number from the given alternatives.

(SSC CGL 1st Sit. 2013)

106. Chisel : Sculptor :: Harrow ?
 (a) Gardener (b) Mason
 (c) Blacksmith (d) Guard
107. Moon : Satellite :: Earth ?
 (a) Sun (b) Planet
 (c) Solar system (d) Round
108. BJCI : JBIC :: CXDW : ?
 (a) JCDU (b) BCJU
 (c) EVFU (d) XCWD
109. AB : NO :: LM : ?
 (a) OL (b) KP
 (c) PK (d) YZ
110. AG : IO :: EK : ?
 (a) LR (b) MS
 (c) PV (d) SY
111. 25 : 175 :: 32 : ?
 (a) 150 (b) 170
 (c) 162 (d) 160

DIRECTIONS (Qs. 112-115): In the questions, select the related letters/word/number from the given alternatives.

(SSC CGL 1st Sit. 2013)

112. F : 216 :: L : ?
 (a) 1700 (b) 1600
 (c) 1723 (d) 1728
113. MOUSE : KPSTC :: LIGHT : ?
 (a) JGEFR (b) JJEIR
 (c) MJHIU (d) MGHFUL
114. Tanning : Leather :: Pyrotechnics : ?
 (a) Fireworks (b) Wool
 (c) Machinery (d) Bombs
115. King : Throne :: Rider ?
 (a) Horse (b) Seat
 (c) Saddle (d) Chair

DIRECTIONS (Qs. 116-119): Select the related words/numbers from the given alternatives.

(SSC CGL 2nd Sit. 2013)

116. A + B + Y + Z = 54
 C + D + W + X = ?
 (a) 45 (b) 54
 (c) 56 (d) 52

117. Petrology : Rocks :: Palaeontology : ?
 (a) Birds (b) Animals
 (c) Fossils (d) Soil
118. Melt : Liquid :: Freeze : ?
 (a) Crystal (b) Solid
 (c) Ice (d) Evaporate
119. 8 : 27 :: ? : 81
 (a) 24 (b) 34
 (c) 44 (d) 54

DIRECTIONS (Qs. 120-123) : In each of the following questions, select the related number/word/letter from given alternatives.

(SSC CGL 2nd Sit. 2013)

120. 9 : 7 :: 80 : ?
 (a) 48 (b) 50
 (c) 78 (d) 82
121. Defer : Put off :: Deduce : ?
 (a) Infer (b) Protect
 (c) Delate (d) Oppose
122. Fish : Gills :: Human : ?
 (a) Heart (b) Lungs
 (c) Nose (d) Mouth
123. CARD : IGXJ :: POST : ?
 (a) UTXY (b) VUYZ
 (c) UTYZ (d) VUXY

DIRECTIONS (Qs. 124-129) : Select the related letter/word/number from the given alternatives.

(SSC Sten. 2013)

124. Cup : Coffee : Bowl : ?
 (a) Dish (b) Soup
 (c) Milk (d) Food
125. Ink : Pen : Petrol : ?
 (a) Bus (b) Car
 (c) Train (d) Tractor
126. MAD : JXA : RUN : ?
 (a) OSQ (b) PRJ
 (c) UXQ (d) ORK
127. 57913 : EGIM : 35816 : ?
 (a) CDIR (b) BCHP
 (c) CEHQ (d) CEHP
128. 8 : 39 :: 72 : ?
 (a) 64 (b) 312
 (c) 351 (d) 300
129. 16 : 36 :: 64 : ?
 (a) 4 (b) 6
 (c) 8 (d) 100

DIRECTIONS (Qs. 130-135) : In each questions below, select the related word/letter/number from the given alternatives.

(SSC Sub. Ins. 2014)

130. Saint : Meditation :: Scientist : ?
 (a) Research (b) Knowledge
 (c) Spiritual (d) Rational
131. King : Palace :: Eskimo : ?
 (a) Caravan (b) Asylum
 (c) Monastery (d) Igloo
132. AFKP : DINS :: WBGL : ?
 (a) ORUX (b) OSWA
 (c) OTYD (d) OQSU

133. SINGER : QGLECP :: MONSTER : ?
 (a) KLNSCP (b) KLMSCP
 (c) KMLQRCP (d) KLMTDO
134. 18 : 5 :: 12 : ?
 (a) 4 (b) 10
 (c) 3 (d) 6
135. 12 : 20 :: ?
 (a) 15 : 37 (b) 16 : 64
 (c) 27 : 48 (d) 30 : 42

DIRECTIONS (Qs. 136-139) : elect the related word/letter/number from the given alternatives.

(SSC Multitasking 2014)

136. 3 : 7 :: 15 : ?
 (a) 30 (b) 35
 (c) 45 (d) 49
137. Kalidas : Meghdoot :: Kautilya : ?
 (a) Ramayana (b) Arthashastra
 (c) Kamayani (d) Kadambari
138. Water : Ocean :: Sand : ?
 (a) Island (b) Waves
 (c) River (d) Desert
139. ABC : XYZ :: CDE : ?
 (a) UVW (b) WXY
 (c) AVW (d) VWX

DIRECTIONS (Qs. 140-145) : Select the related word/letter/number from the given alternatives.

(SSC CGL 1st Sit. 2014)

140. Voyage : Sea sickness :: Heights : ?
 (a) Ship (b) Travel
 (c) Giddiness (d) Motion
141. Waitress : Restaurant :: ?
 (a) Doctor : Nurse (b) Driver : Truck
 (c) Teacher : School (d) Actor : Role
142. AROUND : RAUODN :: GROUND : ?
 (a) RGUODN (b) NDOOGR
 (c) OUNDGR (d) DNUURG
143. APPROACHED : ROACHEDAPP :: BARGAINED : ?
 (a) AINEDBARG (b) GAINEDBAR
 (c) GAINEDRAB (d) RABGAINED
144. 8 : 256 :: ?
 (a) 7 : 343 (b) 9 : 243
 (c) 10 : 500 (d) 5 : 75
145. 21 : 3 :: 574 : ?
 (a) 23 (b) 82
 (c) 97 (d) 113

DIRECTIONS (Qs. 146-151) : Select the related letter/word/number from the given alternatives.

(SSC Sten. 2014)

146. SILK : NDGF : SOIL : ?
 (a) NJDG (b) RNHK
 (c) NIBD (d) NKFJ
147. 7 : 47 :: 9 : ?
 (a) 79 (b) 94
 (c) 50 (d) 81
148. ACF : BDG :: EGJ : ?
 (a) BDF (b) FHK
 (c) EFG (d) ADF

149. ACEF : GIKL :: MOQR : ?
 (a) SUWY (b) TVXZ
 (c) TUXY (d) SUWX
150. Lamp : Oil :: Electric Bulb : ?
 (a) Current (b) Bright
 (c) Holder (d) Switch
151. Poem : Poet :: ? : Book
 (a) Editor (b) Author
 (c) Writer (d) Publisher

DIRECTIONS (Qs. 152-160): In the following Nine questions, select the related word/letters/number from the given alternatives.

(SSC Sten. 2014)

152. Optimist : Cheerful :: Pessimist : ?
 (a) Petty (b) Helpful
 (c) Gloomy (d) Mean
153. GHJM : QRTW :: CDFI : ?
 (a) XYZQ (b) GHIJ
 (c) NOPR (d) MNPS
154. CIQY : DJRZ :: AGOW : ?
 (a) BHPU (b) BJRZ
 (c) BJPX (d) BHPX
155. CAFD : IGLJ :: OMRP : ?
 (a) URSR (b) PONM
 (c) ZYXW (d) USXV
156. 8 : 64 :: 27 : ?
 (a) 212 (b) 125
 (c) 64 (d) 81
157. 4 : 20 :: 6 : ?
 (a) 8 (b) 42
 (c) 36 (d) 12
158. 27 : 9 :: 64 : ?
 (a) 16 (b) 20
 (c) 8 (d) 12
159. Yard : Inch :: Quart : ?
 (a) Milk (b) Liquid
 (c) Gallon (d) Ounce
160. Pesticide : Crop :: Antiseptic : ?
 (a) Bandage (b) Bleeding
 (c) Wound (d) Clothing

DIRECTIONS (Qs. 161-165): In each questions below, select the related word/letters/number from the given alternatives.

(SSC Sub. Ins. 2015)

161. 9 : 24 :: ? : 6
 (a) 3 (b) 2
 (c) 1 (d) 5
162. hive : bee :: eyrie : ?
 (a) Pigeon (b) Sparrow
 (c) Parrot (d) Eagle
163. STAR : RATS :: WARD : ?
 (a) MICE (b) SHINE
 (c) FAME (d) DRAW
164. DCBA : WXYZ :: IJKL : ?
 (a) SRQP (b) QPON
 (c) PONM (d) RQPO

165. DHLPTX : BFJMRV :: CGKOSW : ?
 (a) AIOMUQ (b) UMQEIA
 (c) IJKLMN (d) AEILQU
166. Choose the similar group of numbers on the basis of certain common properties they possess (SSC Sub. Ins. 2015)
 (31, 19, 41)
 (a) (23, 33, 51) (b) (16, 27, 11)
 (c) (27, 29, 47) (d) (29, 17, 37)

DIRECTIONS (Qs. 167-175): Select the related word/letters/number from the given alternatives.

(SSC CHSL 1st Sit. 2015)

167. 6 : 42 :: 5 : ?
 (a) 40 (b) 30
 (c) 35 (d) 45
168. Hockey : India :: Baseball : ?
 (a) USA (b) Russia
 (c) Australia (d) China
169. Ant : Fly : Bee :: Hamster : Squirrel : ?
 (a) Rodent (b) Mouse
 (c) Cat (d) Spider
170. 144 : 13 :: 49 : ?
 (a) 8 (b) 10
 (c) 11 (d) 9
171. ABDE : GHJK :: MNPQ : ?
 (a) RTUW (b) STVW
 (c) CEFH (d) RSUV
172. ACE : GIK :: MOQ : ?
 (a) SUW (b) VXZ
 (c) RTU (d) STU
173. GNIDAER : READING :: NOITULOS : ?
 (a) Solunoit (b) Nailosut
 (c) Pollution (d) Solution
174. Brick : Wall :: Cell : ?
 (a) Chlorophyll (b) Organs
 (c) DNA (d) Tissue
175. 21 : 3 :: 574 : ?
 (a) 23 (b) 82
 (c) 113 (d) 97

DIRECTIONS (Qs. 176-185): select the related word/letters/numbers from the given alternatives.

(SSC CHSL 2nd Sit. 2015)

176. SUMO : PRJL :: TAXI : ?
 (a) WDXJ (b) QDVF
 (c) QXUF (d) QDNF
177. Concord : Agreement :: Discord : ?
 (a) Comparison (b) Conflict
 (c) Association (d) Blended
178. Female : Feminine :: Male : ?
 (a) Man (b) Masculine
 (c) Macho (d) Manager
179. 42 : 20 :: 64 : ?
 (a) 33 (b) 34
 (c) 31 (d) 32
180. PS : VY :: FI : ?
 (a) VZ (b) WZ
 (c) LO (d) UX

181. Carpentry : Skill ___ : Talent
 (a) Singing (b) Plumbing
 (c) Driving (d) Masonry

182. $\frac{1}{4} : \frac{1}{8} :: \frac{2}{3} : \underline{\hspace{1cm}} ?$

- (a) $\frac{1}{2}$ (b) 1
 (c) $\frac{1}{4}$ (d) $\frac{1}{3}$

183. KcaC : CacK :: XgmF : ___?

- (a) FmgX (b) Gmef
 (c) EmgF (d) EgmX

184. Choose the similar group of numbers on the basis of certain common properties they possess:
 (72, 66, 96)

- (a) (24, 69, 58) (b) (55, 66, 77)
 (c) (63, 70, 86) (d) (54, 57, 78)

185. $6 + \sqrt[3]{216}; 7 + \sqrt[3]{343}; 8 + \sqrt[3]{512}; 9 + \sqrt[3]{729}; \quad ? \underline{\hspace{1cm}}$

- (a) $10 + \sqrt{10000}$ (b) $10 + \sqrt{10^5}$
 (c) $10 + \sqrt{100}$ (d) $10 + \sqrt{1000}$

DIRECTIONS (Qs. 186-191): In the following Six Questions, select the related word/letters/number from the given alternatives.

(SSC CGL 1st Sit. 2015)

186. Haematology : Blood :: Phycology : ?

- (a) Fungi (b) Fishes
 (c) Algae (d) Diseases

187. Pride of Lions :: _____ of cats

- (a) Herd (b) School
 (c) Clowder (d) Bunch

188. MAN : PDQ :: WAN : ?

- (a) ZDQ (b) NAW (c) YQD (d) YDQ

189. AEFJ : KOPT :: ? : QUVZ

- (a) GLKP (b) GKLP
 (c) HLKP (d) HKQL

190. 2 : 32 :: 3 : ?

- (a) 243 (b) 293 (c) 183 (d) 143

191. D × H : 4 × 8 as M × Q : ?

- (a) 12 × 17 (b) 12 × 16
 (c) 13 × 17 (d) 14 × 18

DIRECTIONS (Qs. 192-197): In questions, select the related word/letters number from the given alternatives.

(SSC CGL 1st Sit. 2015)

192. BLOCKED : YOLXPVW :: ? : OZFMMS

- (a) LABOURS (b) LAUNNCH
 (c) DEBATES (d) RESULTS

193. 12 : 72 :: 8 : ?

- (a) 36 (b) 32 (c) 38 (d) 40

194. FIG : EGHJFH :: BIN : ?

- (a) ACJHMO (b) CAHJMO
 (c) CAJHOM (d) ACHJMO

195. 6 : 42 :: 7 : ?

- (a) 48 (b) 40 (c) 56 (d) 52

196. Garbage : House :: Gangue : ?

- (a) Factory (b) Drugs
 (c) Office (d) Ore

197. DBU : EEZ :: CJH : ?

- (a) DMN (b) DNM
 (c) DNN (d) DMM

DIRECTIONS (Qs. 198-200): Select the related word/Letters/ numbers from the alternatives.

(SSC CGL 1st Sit. 2016)

198. Pig : Sty :: Dog : ?

- (a) Burrow (b) Hives
 (c) Shed (d) Kennel

199. BDGK : ACFJ :: ? : DFIM

- (a) FKGH (b) EGJN
 (c) EGIK (d) FGHI

200. 01 : 36 :: 02 : ?

- (a) 48 (b) 49
 (c) 69 (d) 70

DIRECTONS : (Qs. 201-203) : Select the related word/letters/ numbers from the given alternatives :

(SSC CGL 1st Sit. 2016)

201. Length : Meter :: Power : ?

- (a) Calories (b) Degree
 (c) Watt (d) Kilogram

202. ZXVT : YWUS :: RPNL : ?

- (a) XVTS (b) TSQP
 (c) SQPM (d) QOMK

203. 42 : 20 :: 64 : ?

- (a) 31 (b) 32
 (c) 33 (d) 34

DIRECTIONS (Qs. 204-206) : Select the related word/letters/ numbers from the given alternatives:

(SSC CGL 2nd Sit. 2016)

204. Cytology : Cells :: ? : Birds

- (a) Odontology (b) Mycology
 (c) Etymology (d) Ornithology

205. RIGT : WDBY :: FUSH : ?

- (a) PKJQ (b) BYWD
 (c) DXWB (d) KPNP

206. 42 : 56 :: 110 : ?

- (a) 18 (b) 132 (c) 136 (d) 140

DIRECTIONS (Qs. 207-209) : Select the related word/letters/ numbers from the given alternatives:

(SSC CGL 2nd Sit. 2016)

207. Medicine : Patient :: Education : ?

- (a) Teacher (b) School
 (c) Student (d) Tuition

208. LAMP : IXJM :: FISH : ?

- (a) CGPF (b) CFQE
 (c) CFPE (d) CGQF

209. 13 : 20 :: 17 : ?

- (a) 25 (b) 26
 (c) 27 (d) 28

DIRECTIONS (Qs. 210-215) : In the following six questions, select the related word/letters/number from the given alternatives.

210. Nurture : Neglect :: Denigrate : ? (SSC CGL 2nd Sit. 2016)
 (a) Extol (b) Reveal
 (c) Recognise (d) Reply
211. ABDG : ZYWT :: BCEH : ?
 (a) YXTS (b) QPRU
 (c) SVXY (d) YXVS
212. Modesty : Arrogance :: ?
 (a) Debility : Strength
 (b) Obese : Fat
 (c) Ship : Fleet
 (d) Speak : Lecture
213. 43 : 57 :: 111 : ?
 (a) 135 (b) 133
 (c) 134 (d) 136
214. AZBY : CXDW :: EVFU : ?
 (a) GTHS (b) FUVU
 (c) ZYEU (d) BXWD
215. 23 : 0827 :: 45 : ?
 (a) 12125 (b) 64125
 (c) 12025 (d) 08125

DIRECTIONS (Qs. 216-218) : In the following questions, select the related word pair from the given alternatives.

216. Power : Watt :: ? : ? (SSC CGL 2017)
 (a) Pressure : Newton (b) Force : Pascal
 (c) Resistance : Mho (d) Work : Joule
217. NPBG : OQCH :: AJOT : ?
 (a) BKPU (b) BUPK
 (c) BHKP (d) HBKU
218. 101 : 10201 :: 107 : ?
 (a) 10707 (b) 10749
 (c) 11449 (d) 11407

DIRECTIONS (Qs. 219-221) : In the following questions, select the related word/number from the given alternatives.

219. Car : Road :: Ship : ? (SSC CGL 2017)
 (a) Water (b) Air
 (c) Road (d) Both Air and Water
220. GLOW : FJNU :: PTEL : ?
 (a) ORFN (b) ORDJ
 (c) ORJD (d) OPNF
221. 5 : 124 : 6 : ?
 (a) 215 (b) 216
 (c) 217 (d) 220

DIRECTIONS (Qs. 222-224) : In the following questions, select the related word pair from the given alternatives.

222. Kilometre : Metre :: Tonne : ? (SSC CGL 2017)
 (a) Litre (b) Kilogram
 (c) Hours (d) Weight
223. AGN : IOV :: BLM : ?
 (a) JTV (b) KTU
 (c) JUV (d) TUJ

224. 9143 : 9963 :: 6731 : ?

- (a) 1368 (b) 5666
 (c) 8964 (d) 9694

DIRECTIONS (Qs. 225-227) : In the following question, select related word pair/number from the given alternatives.

225. Fire : Burn :: ? : ? (SSC CGL 2017)
 (a) Water : Drink (b) Wood : Tress
 (c) Ice : Freeze (d) Flower : Rose
226. KLMN : IJKL :: TUVW : ?
 (a) RSUT (b) VWXY
 (c) STUV (d) RSTU
227. 3 : 27 :: 4 : ?
 (a) 63 (b) 64
 (c) 65 (d) 15

DIRECTIONS (Qs. 228-231) : Choose the related word/letters number from the given alternatives.

228. Horse : Neigh :: Elephant : ? (SSC CHSL 2017)
 (a) Quack (b) Trumpet
 (c) Mew (d) Grunt
229. GH : 78 :: ? : 1819
 (a) HG (b) LM
 (c) RS (d) IJ
230. CAR : RAC :: TYRE : ?
 (a) RUBBER (b) ERTY
 (c) ERYT (d) STEEL
231. 12 : 60 :: 28 : ?
 (a) 160 (b) 150
 (c) 145 (d) 140

DIRECTIONS (232 to 235) : Select the related word/ letters/ number from the given alternatives.

232. RATE : EATR :: SEAT : ? (SSC MTS 2017)
 (a) TSEA (b) TESA
 (c) TEAS (d) TSAE
233. Book : Literature :: ? : ?
 (a) Man : Beast (b) Dancer : Musician
 (c) Song : Music (d) Species : Science
234. 21 : 3 :: 574 : ?
 (a) 97 (b) 23
 (c) 82 (d) 113
235. Giant : Dwarf :: Genius : ?
 (a) Tiny (b) Gentle
 (c) Idiot (d) Wicked

DIRECTIONS (Qs. 236-241) : In the following question, select the related word from the given alternatives.

236. Influenza : Virus :: Ringworm : ? (SSC Sub. Ins. 2017)
 (a) Bacteria (b) Fungi
 (c) parasite (d) Protozoa
237. Fan : Blades :: ? : ?
 (a) Bonnet : Car (b) Room : House
 (c) Arc : Circle (d) Book : Chapter

238. LSFW : NTHX :: PKWE : ?
 (a) RYLF (b) RLYE
 (c) RLYF (d) RLGf
239. LMNO : NQTW :: GHIJ : ?
 (a) ILOR (b) ILRO
 (c) ILMO (d) LRMO
240. 11 : 120 :: 13 : ?
 (a) 165 (b) 168
 (c) 170 (d) 169
241. 103 : 10609 :: 106 : ?
 (a) 10606 (b) 10306
 (c) 11236 (d) 13636

DIRECTIONS (242-250) : In the following question, select the related from the given alternatives.

242. 11 : 121 :: 12 : ? (SSC Steno. 2017)
 (a) 144 (b) 169
 (c) 196 (d) 154
243. 15 : 256 :: 14 : ?
 (a) 225 (b) 144
 (c) 25 (d) 95
244. 108 : 11664 :: 107 : ?
 (a) 11449 (b) 10449
 (c) 10849 (d) 11749
245. CHARGER : DGBQHOS :: CELLULAR : ?
 (a) DDMKVKBQ (b) DDNKKVBQ
 (c) DDMKUKCQ (d) DDNKUBVQ
246. ROME : QNLD :: MORE : ?
 (a) LNQD (b) LNQC
 (c) LMQD (d) LMQC
247. CHANNEL : XSZMMVO : MUSICAL : ?
 (a) NFHRXZO (b) NFHQYZP
 (c) NEHRXZP (d) NFIRXZO
248. Rain : Clouds :: Heat : ?
 (a) Distance (b) Sun
 (c) Night (d) Day
249. Garden : Plants :: Book : ?
 (a) Words (b) Pages
 (c) Writing (d) White
250. Doctor : Patient :: Teacher : ?
 (a) Teach (b) Student
 (c) School (d) Old
251. Select the word pair in which the two words are related in the same way as the two words in the following word-pair.
 Season : Winter (SSC CGL 2018)
 (a) Week : Calendar (b) Summer : Autumn
 (c) Year : Century (d) Month : April
252. Select the option that is related to the third number in the same way as the second number is related to the first number.
 12 : 68 :: 21 : ? (SSC CGL 2018)
 (a) 49 (b) 117 (c) 119 (d) 79

253. Select the option that is related to the third number in the same way as the second number is related to the first number.
 12 : 192 :: 15 : ? (SSC CGL 2018)
 (a) 245 (b) 240
 (c) 225 (d) 250
254. Select the word-pair in which the two words are related in the same way as the two words in the following word-pair.
 Dirty : Filthy (SSC CGL 2018)
 (a) Perfect : Unique (b) Shy : Timid
 (c) Cute : Child (d) Bright : Sunlight
255. 'Heart' is related to 'Circulation in the same way as 'Kidney' is related to _____. (SSC CGL 2018)
 (a) Reproduction (b) Respiration
 (c) Energy Production (d) Excretion
256. 'Machine' is related to 'Operator' in the same way as 'Car' is related to '_____'. (SSC CHSL 2018)
 (a) Driver (b) Bus
 (c) Mechanic (d) Engine
257. Select the set in which the numbers are related in the same way as are the numbers of the following set. (SSC CHSL 2018)
 (64, 100, 328)
 (a) (16, 36, 54) (b) (49, 81, 137)
 (c) (25, 49, 148) (d) (36, 64, 97)
258. Select the set in which the numbers are related in the same way as are the numbers of the following set. (SSC CHSL 2018)
 (45, 49, 47)
 (a) (25, 54, 79) (b) (15, 19, 37)
 (c) (5, 39, 44) (d) (35, 59, 47)
259. Select the option that is related to the third letter-pair in the same way as the second letter-pair is related to the first letter-pair. (SSC CHSL 2018)
 PM : UT :: RU : ?
 (a) XA (b) XB
 (c) WA (d) WB
260. Select the number-pair in which the two numbers are related in the same way as are the two numbers of the following number-pair. (SSC CHSL 2018)
 42 : 56
 (a) 17 : 49 (b) 22 : 44
 (c) 35 : 51 (d) 12 : 20
261. Select the word-pair in which the two words are related in the same way as are the two words in the following word-pair. (SSC CHSL 2018)
 Trim : Hair
 (a) Dog : Stag (b) Eye : Red
 (c) Prune : Shrub (d) Nail : Face
262. 'Disease' is related to 'Pain' in the same way as 'Accident' is related to _____. (SSC Sub. Ins. 2018)
 (a) Collision (b) Carelessness
 (c) Injury (d) Driving

263. Select the option that is related to the third number in the same way as the second number is related to the first number.
24 : 13 :: 38 : _____ (SSC Sub. Ins. 2018)
(a) 23 (b) 17
(c) 20 (d) 25
264. 'Bird' is related to 'Wings' in the same way as 'Fish' is related to '_____'. (SSC Sub. Ins. 2018)
(a) Gills (b) Fins
(c) Scales (d) Belly
265. Select the set of numbers that is similar to the following set.
{9, 10, 23} (SSC Sub. Ins. 2018)
(a) {15, 24, 33} (b) {7, 15, 25}
(c) {16, 25, 32} (d) {4, 9, 16}
266. Select the option that is related to the third number in the same way as the second number is related to the first number.
6 : 35 :: 9 : _____ (SSC Sub. Ins. 2018)
(a) 65 (b) 85
(c) 80 (d) 99
267. Select the option that is related to the third term in the same way as the second term is related to the first term.
HKNQ : JIPO :: DGJM : _____ (SSC Sub. Ins. 2018)
(a) EELK (b) FELK
(c) FEJK (d) FENO
268. Select the word pair in which the two words are related in the same way as are the two words in the given word-pair.
Small : Dimension (SSC Sub. Ins. 2018)
(a) Cold : Winter (b) Heat : Temperature
(c) Triangle : Area (d) Heavy : Weight
269. Select the option that is related to the third term in the same way as the second term is related to the first term.
ATKR : FYPW :: TLPG : _____ (SSC Sub. Ins. 2018)
(a) XTQL (b) YTQL
(c) XQTL (d) YQUL
270. Select the set of numbers that is similar to the following set.
{10, 19, 32} (SSC Sub. Ins. 2018)
(a) {12, 25, 49} (b) {5, 14, 19}
(c) {7, 13, 23} (d) {3, 7, 10}
271. Select the word-pair in which the two words are related in the same way as are the two words in the given word-pair.
Circle : Circumference (SSC Sub. Ins. 2018)
(a) Triangle : Area (b) Plane : Dimension
(c) Square : Diagonal (d) Rectangle : Perimeter
272. Select the correct alternative to indicate the arrangement of the following words in a logical and meaningful order.
(SSC Sub. Ins. 2018)
- | | |
|-------------|-------------|
| 1. Injury | 2. Recovery |
| 3. Accident | 4. Showroom |
| 5. Drive | 6. Car |
- (a) 6, 4, 3, 5, 1, 2 (b) 5, 6, 3, 2, 1, 4
(c) 4, 6, 5, 3, 1, 2 (d) 4, 6, 5, 3, 2, 1
273. Select the number-pair in which the two numbers are related in the same way as are the two numbers in the given pair.
65 : 126 (SSC Sub. Ins. 2018)
- (a) 9 : 28 (b) 2 : 10
(c) 26 : 65 (d) 37 : 50
274. Select the option that is related to the third term in the same way as the second term is related to the first term.
(SSC Stenographer 2018)
VEGT : SHJQ :: FGCM : ?
(a) BJFJ (b) CJPJ (c) CJFJ (d) DJPJ
275. Chlorine is related to Halogen in the same way as Neon is related to _____. (SSC Stenographer 2018)
(a) Metal (b) Radio Active
(c) Gas (d) Inert Gas
276. Select the option that is related to the third term in the same way as the second term is related to the first term.
Jurist : Law :: Orator : ? (SSC Stenographer 2018)
(a) Lawyer (b) Writing
(c) Acting (d) Speech
277. Find the missing term in the given analogous pair.
1 : 4, 3 : 14 :: 5 : 32, 7 : _____ (SSC Stenographer 2018)
(a) 58 (b) 79 (c) 85 (d) 97
278. Select the option that is related to the third term in the same way as the second term is related to the first term.
Grief : Anguish :: Pique : ? (SSC Stenographer 2018)
(a) Joy (b) Anger (c) Jealous (d) Tensed
279. Select the option that is related to the third term in the same way as the second term is related to the first term.
45 : 135 :: 60 : ? (SSC Stenographer 2018)
(a) 175 (b) 210 (c) 140 (d) 180
280. Select the option that is related to the third term in the same way as the second term is related to the first term.
56 : 8 :: 91 : ? (SSC Stenographer 2018)
(a) 17 (b) 13 (c) 15
(d) 19
281. Select the option in which the numbers are related in the same way as are the numbers in the given set.
(269, 278, 296) (SSC CGL 2019-20)
(a) 313, 322, 340 (b) 109, 118, 128
(c) 419, 430, 448 (d) 577, 586, 598
282. Select the option that is related to the third word in the same way as the second word is related to the first word.
Medicine : Disease :: Food : ? (SSC CGL 2019-20)
(a) Hunger (b) Energy
(c) Nutrition (d) Thirst
283. Select the option that is related to the third number in the same way as the second number is related to the first number and the sixth number is related to the fifth number.
12 : 72 :: 18 : ? :: 22 : 242 (SSC CGL 2019-20)
(a) 162 (b) 140
(c) 160 (d) 164
284. Select the option in which the words share the same relationship as that shared by the given pair of words.
Clock : Time (SSC CGL 2019-20)
(a) Ammeter : Current (b) Taseometer : Wind
(c) Balance : Scale (d) Anemometer : Strains

285. Select the option that is related to the third number in the same way as the second number related to the first number.
35 : 66 :: 29 : ? (SSC MTS 2019-20)
(a) 63 (b) 62
(c) 60 (d) 57
286. Select the word pair in which the two words are related in the same way as the two words in the following word-pair?
Five : Pentagon (SSC MTS 2019-20)
(a) Four : Rectangle (b) Triangle : Three
(c) Square : Four (d) Six : Septagon
287. Select the option that is related to the third term in the same way as the second term is related to the first term.
Colour : Red :: Profession : ? (SSC MTS 2019-20)
(a) Lawyer (b) Court
(c) School (d) Black
288. Select the option in which the letters share the same relationship as that shared by the given pair of letters.
JT : NX (SSC MTS 2019-20)
(a) TP : XT (b) RK : VG
(c) GS : KU (d) LD : PG
289. Select the option in which the numbers share the same relationship as that shared by the given number-pair.
34 : 210 (SSC CHSL 2019-20)
(a) 47 : 282 (b) 66 : 402
(c) 54 : 100 (d) 38 : 236
290. Select the option in which the numbers are related in the same way as are the numbers in the given set.
(5, 6, 61) (SSC CHSL 2019-20)
(a) (3, 8, 24) (b) (9, 4, 26)
(c) (5, 2, 49) (d) (3, 4, 25)
291. Select the option that is related to the third term in the same way as the second term is related to the first term.
EASY : IETZ :: LAKE : _____ (SSC CHSL 2019-20)
(a) MELI (b) PELI
(c) MBLL (d) PBKL
292. Select the option in which the numbers are related in the same way as are the numbers in the given set.
(9, 217, 8) (SSC CHSL 2019-20)
(a) (4, 37, 3) (b) (2, 76, 5)
(c) (5, 625, 6) (d) (3, 49, 2)
293. Four number-pairs have been given, out of which three are alike in some manner and one is different. Select the number-pair that is different from the rest. (SSC CHSL 2019-20)
(a) 7-50 (b) 4-17
(c) 6-35 (d) 5-26
294. Select the option that is related to the third letter-cluster in the same way as the second letter-cluster is related to the first letter-cluster.
LAME : OXPB :: TREE : ? (SSC CHSL 2019-20)
(a) VNGB (b) UMFA
(c) WOHB (d) QUBH
295. Select the option in which the words share the same relationship as that shared by the given pair of words.
Handwriting : Graphology (SSC CGL 2020-21)
(a) Soil : Ornithology (b) Earthquakes : Pomology
(c) Matter : Physics (d) Fossils : Pedology
296. Select the option that is related to the third number in the same way as the second number is related to the first number and the sixth number is related to the fifth number.
13 : 4 :: 19 : ? :: 16 : 5 (SSC CGL 2020-21)
(a) 6 (b) 2
(c) 3 (d) 5
297. Select the option in which the numbers are related in the same way as are the numbers of the following set.
(7, 52, 346) (SSC CGL 2020-21)
(a) (8, 67, 515) (b) (4, 19, 70)
(c) (6, 39, 217) (d) (5, 25, 128)
298. Select the option that is related to the third word in the same way as the second word is related to the first word.
Nascent : Young :: Adjunct : ? (SSC CGL 2020-21)
(a) Against (b) Supportive
(c) Functional (d) Rigid
299. Select the option in which the numbers in the set share the same relationship as that shared by the numbers of the given set.
(14, 18, 42) (SSC CHSL 2020-21)
(a) 22, 18, 74 (b) 40, 23, 94
(c) 20, 15, 100 (d) 16, 21, 56
300. Select the option that is related to the fourth number in the same way as the first number is related to the second number and the fifth number is related to the sixth number.
127 : 11 :: ? : 16 :: 367 : 19 (SSC CHSL 2020-21)
(a) 262 (b) 216
(c) 280 (d) 248
301. 'East' is related to 'Direction' in the same way as 'Summer' is related to '_____'. (SSC CHSL 2020-21)
(a) Temperature (b) Room Cooler
(c) Season (d) Heat
302. Select the option in which the numbers are related in the same way as are the numbers of the following set.
(2, 3, 62) (SSC CHSL 2020-21)
(a) 6, 4, 122 (b) 7, 4, 226
(c) 5, 9, 288 (d) 8, 5, 225
303. Select the option that is related to the third letter-cluster in the same way as the second letter-cluster is related to the first letter-cluster.
AZW : GFC :: LSM : ? (SSC CHSL 2020-21)
(a) RYS (b) DMT
(c) QOS (d) RXY
304. Select the option in which the words share the same relationship as that shared by the given pair of words.
Astronomy : Stars (SSC CHSL 2020-21)
(a) Philology : Texture (b) Seismology : Theater
(c) Psychology : Cells (d) Numismatics : Coins
305. 'Tired' is related to 'Exhausted' in the same way as 'Sad' is related to '_____'. (SSC MTS 2020-21)
(a) Depressed (b) Happy
(c) Mood (d) Feeling

306. 'Density' is related to 'Hydrometer' in the same way as 'Mass' is related to '_____'. (SSC MTS 2020-21)
 (a) Heaviness (b) Kilogram
 (c) Balance (d) Volume
307. Select the number from the options that is similar to the numbers in the given set. (SSC MTS 2020-21)
 (425, 902, 713)
 (a) 555 (b) 624
 (c) 319 (d) 218
308. Select the number-pair in which the two numbers are related in the same way as the two numbers of the pair given below.
 20 : 68 (SSC MTS 2020-21)
 (a) 30 : 110 (b) 25 : 90
 (c) 12 : 30 (d) 5 : 18
309. Select the option that is related to the third letter-cluster in the same way as the second letter-cluster is related to the first letter-cluster. (SSC MTS 2020-21)
 FHKO : UQNL :: MORV : ?
 (a) NLIE (b) NIFD
 (c) PLIG (d) NJGE
310. Select the number that is related to the third number in the same way as the second number is related to the first number.
 14 : 238 :: 18 : ? (SSC Stenographer 2020-21)
 (a) 301 (b) 342
 (c) 651 (d) 405
311. Select the option that is related to the third letter-cluster in the same way as the second letter-cluster is related to the first letter-cluster?
 MOCK : NLXP :: DART : ? (SSC Stenographer 2020-21)
 (a) VZIH (b) WZIG
 (c) WZJG (d) ZYKI
312. Study the given pattern carefully and select the number that can replace the question mark (?) in it.
 (13, 4, 18) (49, 24, 50) (87, 51, ?)
 (a) 84 (b) 69
 (c) 72 (d) 76
313. Select the option that is related to the third letter-cluster in the same way as the second letter-cluster is related to the first letter-cluster. (SSC Stenographer 2020-21)
 FRAGILE : RLIGFEA :: CAUTION : ?
 (a) UTOINCA (b) OTUNICA
 (c) UOTNICA (d) UTONICA
314. Select the option that is related to the third letter-cluster in the same way as the second letter-cluster is related to the first letter-cluster.
 CARE : HUDF : TOMB : ? (SSC Stenographer 2020-21)
 (a) DPRX (b) EQRX
 (c) FPSW (d) EPRW
315. Select the number-pair in which the two numbers are related in the same way as are the two numbers of the following number-pair.
 16 : 224 (SSC Sub-Inspector 2020-21)
 (a) 20 : 400 (b) 22 : 440 (c) 25 : 650 (d) 17 : 289
316. Select the option that is related to the third Letter-cluster in the same way as the second letter-cluster is related to the first letter-cluster.
 ABSORPTION : ROSBANOITP :: VISUALIZER : ?
 (SSC Sub-Inspector 2020-21)
 (a) UASIVERZIL (b) VUAISREZIL
 (c) AUSIVREZIL (d) AUSIVREILZ
317. Select the option that is related to the third Letter-cluster in the same way as the second letter-cluster is related to the first letter-cluster, (SSC Sub-Inspector 2020-21)
 SLOW : MPTX :: CAUGHT : ?
 (a) BDHIUV (b) BDIUVH
 (c) WVHIUV (d) DBVHIU

Hints & Solutions

1. (c) As,

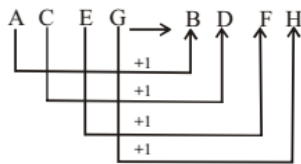

Similarly,

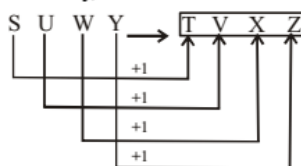

2. (a) As,

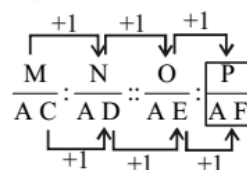

3. (a) As, $5 \times 5 + 2 = 27$

$$\text{Similarly, } 9 \times 9 + 2 = \boxed{83}$$

4. (c) As, $6 \times 2 - 1 = 11$

$$\text{Similarly, } 11 \times 2 - 1 = \boxed{21}$$

5. (c) As, $A + B + E \Rightarrow 1 + 2 + 5 = 8$

Similarly,

$$K + L + O \Rightarrow 11 + 12 + 15 = \boxed{38}$$

6. (b) The resting place of pig is called Sty. Similarly, the resting place of cow is called Byre.

7. (d) In order to ensure security, police or defence personnel patrol the area. Similarly, to cover risk, insurance is done.

8. (b) As,

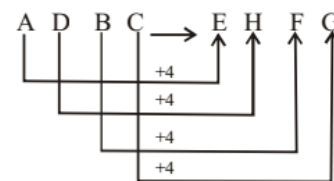

24. (a) As,



Similarly,

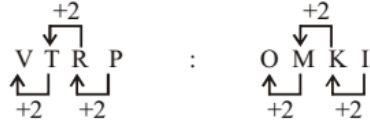

25. (b) As, $17 \times 3 + 9 = 51 + 9 = 60$

Similarly, $20 \times 3 + 9 = 60 + 9 = 69$

26. (b) As, $(6 + 2)^2 = (8)^2 = 64$

Similarly, $(11 + 2)^2 = (13)^2 = 169$

27. (d) As, $123 \Rightarrow 12 \div 3 = 4$

Similarly, $726 \Rightarrow 72 \div 6 = 12$

28. (d) President is the head of Union Executive of a India. Similarly, Governor is the head of State Executive.

29. (c) Mirage is an illusion caused by hot air conditions making one see something that is not there, especially the appearance of a sheet of water on a hot road or in a desert. Similarly, Rainbow is an arch of seven colours formed in the sky when the sun shines through rain.

30. (b) The letters have been written in reverse order.

TEKCAR \Rightarrow RACKET

Similarly,

TCEJBO \Rightarrow OBJECT

31. (d) First three letters are consecutive letters but in reverse order and the fourth letter comes immediately after the first letter in the English alphabetical series.

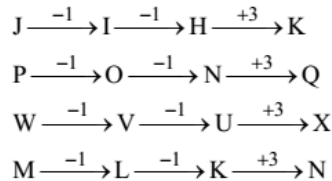

32. (d) As, U U W X

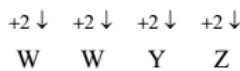

Similarly,

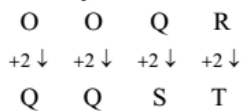

33. (a) As,

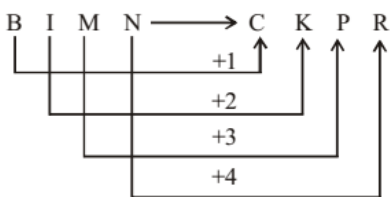

Similarly,

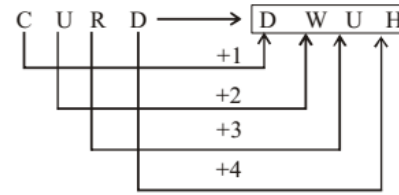

34. (c) As,

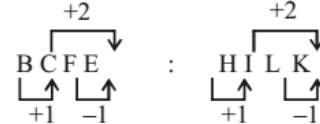

Similarly,

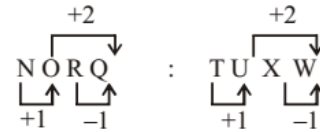

35. (d) $2^2 - 1 = 3$
 $4^3 - 1 = 63$
 $3^2 - 1 = 8$
 $3^3 - 1 = 26$

36. (b) $7 + 2 = 9$; $5 + 3 = 8$
 $9 - 8 = 1$
 $6 + 4 = 10$; $5 + 4 = 9$
 $10 - 9 = 1$

37. (c) As, $6 = 3 \times 2$ Similarly, $8 = 4 \times 2$
 $3 + 2 = 5$ $4 + 2 = 6$

38. (c) As, Blue whale is heaviest animal in the sea. Similarly, Elephant is heaviest animal on the land.

39. (c) Anaemia is the lack of blood. Similarly, Anarchy is the lack of government.

40. (c) As, rock is a hard substance. Similarly, sponge is a soft substance.

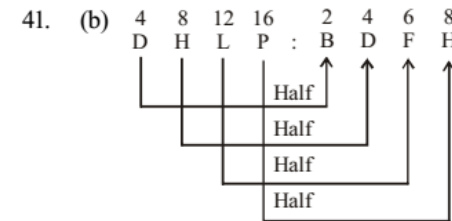

Similarly,

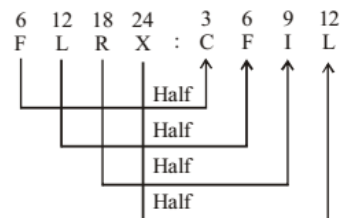

42. (d)

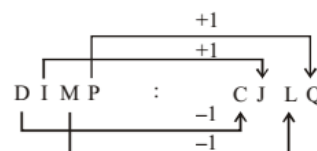

Similarly,

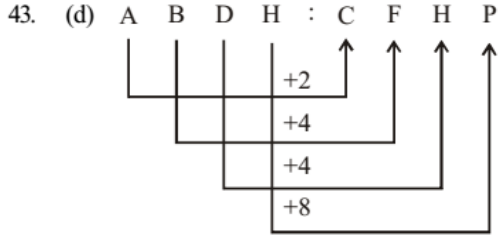
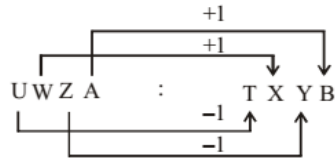

Similarly,

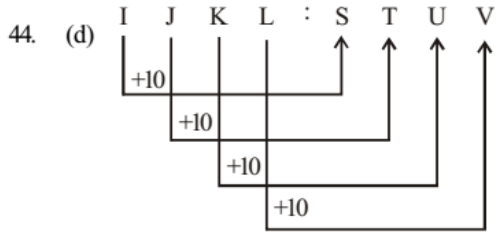
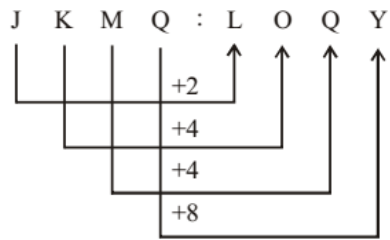

Similarly,

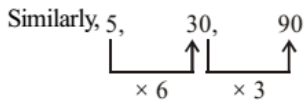
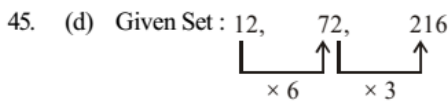
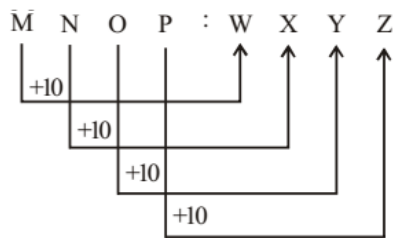

∴ Option (d) satisfy the condition.

46. (a) Fresco is an art of painting that is done on freshly spread moist lime plaster.

47. (c) Elephant used their tusk as digging and bring tools and parrot used their beak for eating and crushing object.

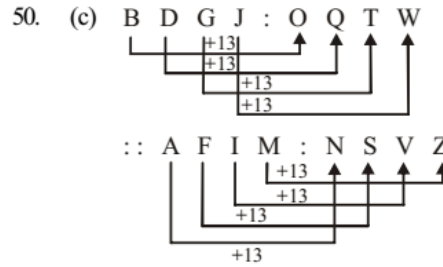
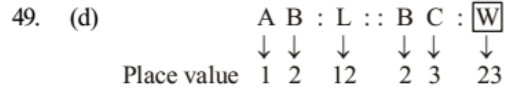
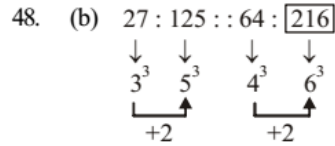

51. (b) $8^2 - 2 = 62$
 $9^2 - 2 = 79$

52. (a) The relationship is $x : (2x - 4)$
 $8 \times 2 - 4 = 16 - 4 = 12$

Similarly, $6 \times 2 - 4 = 12 - 4 = 8$

53. (a) $(1)^2 = 1 ; (3)^2 = 9 \Rightarrow 19$

54. (a) The movement of eagle is like swooping. Similarly, the movement of duck is called waddle.

55. (a) As, A P P L E
 $1 + 16 + 16 + 12 + 5 = 50$

Similarly,

O R A N G E
 $15 + 18 + 1 + 14 + 7 + 5 = 60$

56. (c) We pay rent for accommodation. Similarly, we pay fare for journey.

57. (b) Fire causes smoke. Smoke comes out when something is burnt in fire. Similarly, cloud causes rain.

58. (d) Grenade and gun are fire arms. Similarly, head and brain are sensitive organs.

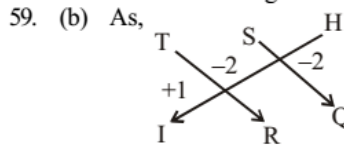

Similarly,

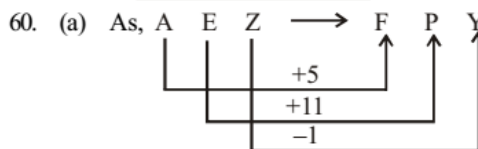
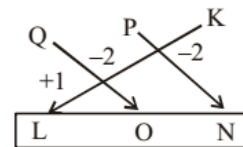

Similarly,

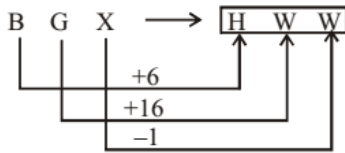

61. (b) Zoology is the scientific study of animals. Similarly, Psychology is study of the mind and how it functions. It is the study of human and animals behaviour.

62. (b)

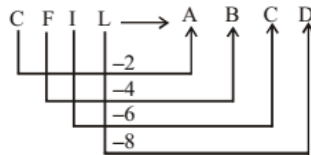

Similarly,

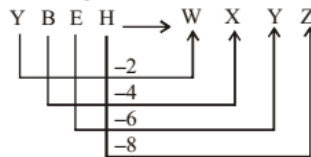

63. (a) $L \times M = 12 \times 13$
Position Number in the English alphabet series.
Similarly,

$$U \times W = \boxed{21 \times 23}$$

64. (d) Man is a mammal. Man belongs to the class Mammal. Similarly, offspring is a part of family.

65. (c) As, $6 - 2 = 4$; $\frac{4}{2} = 2$

Similarly, $8 - 2 = 6$; $\frac{6}{2} = 3$

66. (d)



Pairs of Opposite Letters.

Similarly,

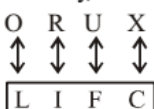

67. (a) As, $1 \times 8 = 8$

Similarly, $4 \times 8 = \boxed{32}$

68. (c) Life starts with the formation of embryo. When life ends dead body is left.

69. (a) $E \leftrightarrow V$ $F \leftrightarrow U$

Pairs of Opposite Letters

$$U \xrightarrow{-1} T$$

$$T \leftrightarrow G \quad S \leftrightarrow H$$

Pairs of Opposite Letters

$$I \leftrightarrow R \quad J \leftrightarrow Q$$

Pairs of Opposite Letters

$$Q \xrightarrow{-1} P$$

$$P \leftrightarrow K \quad O \leftrightarrow L$$

Pairs of Opposite Letters

70. (d) The relationship between the numbers is :
 $x : (x^2 - 1)$
 $(9)^2 - 1 = 81 - 1 = 80$
 $(100)^2 - 1 = 10000 - 1 = 9999$

71. (c) The relationship between the numbers is :
 $x^2 : x^3$
 $(5)^2 = 25$; $(5)^3 = 125$
 $(6)^2 = 36$; $(6)^3 = 216$

72. (a) The relationship between the numbers is :
 $x : x - 119$
 $335 - 119 = 216$
 $987 - 119 = 868$

73. (b)

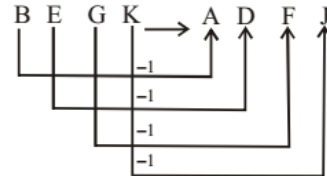

Similarly,

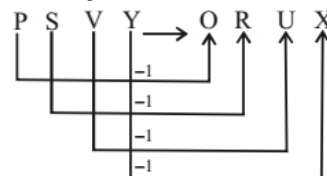

74. (a) Pairs of consecutive opposite letters are given :
AZ, BY, CX, DW; EV, FU; GT, HS

75. (d) $B \xrightarrow{+2} D \xrightarrow{+2} F \xrightarrow{+2} H$
 $S \xrightarrow{+2} U \xrightarrow{+2} W \xrightarrow{+2} Y$

$$B \xrightarrow{+1} C$$

$$C \xrightarrow{+2} E \xrightarrow{+2} G \xrightarrow{+2} I$$

$$S \xrightarrow{+1} T$$

$$T \xrightarrow{+2} V \xrightarrow{+2} X \xrightarrow{+2} Z$$

76. (b) Food is necessary for man. Similarly, fuel is necessary for fire.

77. (c) Spiritual and Belief are inter-related terms. Similarly, Orchestral and music are related.

78. (c) Latter and Former are antonymous to each other. Similarly, Hazardous and Safe are antonymous to each other.

79. (c) Metre is a unit of length likewise watt is a unit of power.

80. (d) As, cube is 3-D of square. Similarly, sphere is 3-D of circle.

81. (b) As, paper is product of Tree. Similarly, glass is a product of sand.

82. (d) As, A C F J

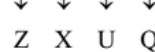

Similarly, E G I N



83. (a) As, $A \xrightarrow{+3} D$ Similarly $Q \xrightarrow{+3} T$
 $C \xrightarrow{+3} F$ $S \xrightarrow{+3} V$
 $E \xrightarrow{+3} H$ $U \xrightarrow{+3} X$
 $G \xrightarrow{+3} J$ $W \xrightarrow{+3} Z$
84. (d) As, $E \xrightarrow{+1} F$ Similarly $F \xrightarrow{+1} G$
 $G \xrightarrow{+2} I$ $H \xrightarrow{+2} J$
 $I \xrightarrow{+3} L$ $J \xrightarrow{+3} M$
 $K \xrightarrow{+4} O$ $L \xrightarrow{+4} P$
85. (b) The relationship is $x : (x^2 - 9)$.
86. (c) The relationship is $x : x(x + 1)$
87. (b) $20 \times 2.5 = 50$
 $100 \times 2.5 = 250$
88. (c) $A \xrightarrow{+3} D \xrightarrow{+4} H \xrightarrow{+5} M$
 $Z \xrightarrow{-5} U \xrightarrow{-4} Q \xrightarrow{-3} N$
 Similarly,
 $G \xrightarrow{+2} I \xrightarrow{+2} K \xrightarrow{+2} M$
 $T \xrightarrow{-2} R \xrightarrow{-2} P \xrightarrow{-2} N$
89. (c) $7 \times 19 = 133$
 Similarly,
 $9 \times 19 = 171$
90. (a) $(6)^2 = 36$; $(6)^3 = 216$
 Similarly,
 $(9)^2 = 81$; $(9)^3 = 729$
91. (a) Victory is joyful. Similarly, defeat is sorrowful.
92. (b) Stomach is a part of body. Similarly, library has different kinds of books.
93. (d) $H \ A \ N \ D \xrightarrow{+2} J \ B \ P \ E$
 $\downarrow \quad \downarrow \quad \downarrow \quad \downarrow$
 $\downarrow \quad \downarrow \quad \downarrow \quad \downarrow$
 $\downarrow \quad \downarrow \quad \downarrow \quad \downarrow$
 $\downarrow \quad \downarrow \quad \downarrow \quad \downarrow$
 Similarly,
 $P \ A \ L \ M \xrightarrow{+2} R \ B \ N \ N$
 $\downarrow \quad \downarrow \quad \downarrow \quad \downarrow$
 $\downarrow \quad \downarrow \quad \downarrow \quad \downarrow$
 $\downarrow \quad \downarrow \quad \downarrow \quad \downarrow$
 $\downarrow \quad \downarrow \quad \downarrow \quad \downarrow$
94. (d) Astronomy is the branch of science which deals with celestial objects such as moons, planets, stars, galaxies etc. While geology is the science which deals with the physical substance of the earth, their history, and the processes which act on them.
95. (c) Second is the opposite of first.
96. (b) $M \ O \ Q \ S \quad A \ C \ E \ G \quad P \ R \ T \ V$
 $\downarrow \downarrow \downarrow \downarrow \quad \downarrow \downarrow \downarrow \downarrow \quad \downarrow \downarrow \downarrow \downarrow$
 $+2 \ +2 \ +2 \quad +2 \ +2 \ +2 \quad +2 \ +2 \ +2$
 $O \ Q \ S \ U$
 $\downarrow \downarrow \downarrow$
 $+2 \ +2 \ +2$
97. (a) $36 = 6^2$ $144 = 12^2$
 $49 = 7^2$ $196 = 14^2$

98. (a) $7 \times 6 = 42$
 $6 \times 6 = 36$
99. (d) Picture is seen. Similarly, book is read.
100. (b) Both are antonyms.
101. (a) Swimming is done in the river.
 Hiking is done from mountain.
102. (c) Word has been written in reverse order.
 1 2 3 4 5 6 7
 H O P E F U L
 coded as- L U F E P O H
 7 6 5 4 3 2 1
 Similarly,
 1 2 3 4 5 6 7 8 9
 E T H N I C I T Y
 Y T I C I N H T E
 9 8 7 6 5 4 3 2 1
103. (c) The given set is $(23 : 30 : 37) = 23 + 7 = 30 + 7 = 37$
 Similarly, $(6 : 13 : 20) = 6 + 7 = 13 + 7 = 20$
104. (b) The sound made by horse is called Neigh. Similarly, the sound made by a bell is called chime.
105. (a) As,
 $A \xrightarrow{+2} C \xrightarrow{+2} E$
 $R \xrightarrow{+2} T \xrightarrow{+2} V$
 $B \xrightarrow{+2} D \xrightarrow{+2} F$
 $F \xrightarrow{+2} H \xrightarrow{+2} J$
106. (a) Here, Tool–Worker relationship has been shown. Chisel is the tool of Sculptor. Similarly, Harrow is the tool of Gardener.
107. (b) Moon is a Satellite. Earth is a Planet.
108. (d) As
 $B \ J \quad C \ I$
 $\swarrow \searrow \quad \swarrow \searrow$
 $J \ B \quad I \ C$
 Similarly
 $C \ X \quad D \ W$
 $\swarrow \searrow \quad \swarrow \searrow$
 $X \ C \quad W \ D$
109. (d) As,
 $A \ B \xrightarrow{+13} N \ O$
 $\downarrow \quad \downarrow$
 $\downarrow \quad \downarrow$
 Similarly
 $L \ M \xrightarrow{+13} Y \ Z$
 $\downarrow \quad \downarrow$
 $\downarrow \quad \downarrow$
110. (b) As,
 $A \ G \xrightarrow{+8} I \ O$
 $\downarrow \quad \downarrow$
 $\downarrow \quad \downarrow$

Similarly

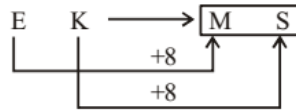

111. (d) As,
 $25 \Rightarrow 25 \times (2 + 5) = 175$
 Similarly,
 $32 \Rightarrow 32 \times (3 + 2) = \boxed{160}$

112. (d) $F \Rightarrow 6$; $(6)^3 = 216$
 Similarly,
 $L \Rightarrow 12$; $(12)^3 = 1728$

113. (b) As, $M \xrightarrow{-2} K$
 $O \xrightarrow{+1} P$
 $U \xrightarrow{-2} S$
 $S \xrightarrow{+1} T$
 $E \xrightarrow{-2} C$

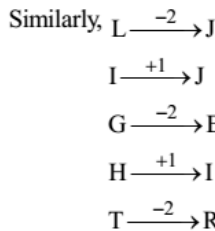

114. (a) Tanning is the art of manufacturing leather. Similarly, Pyrotechnics is the art of manufacturing fireworks.

115. (c) A king sits in a throne. Similarly, a rider sits on a saddle on the back of a horse.

116. (b) $A + B + Y + Z = 1 + 2 + 25 + 26 = 54$
 $\therefore C + D + W + X = 3 + 4 + 24 + 23 = 54$

117. (c) Petrology is the branch of geology that deals with the origin, composition, structure and alteration of rocks. Therefore, palaeontology is the study of fossils to determine the structure and evolution of extinct animals and plants and the age and the conditions of deposition of the rock strata in which they are found.

118. (c) First is the process of formation of the second.

119. (a) $27 \times 3 = 81 \therefore 8 \times 3 = 24$

120. (c) $(3)^2 = 9$; $(3)^2 - 2 = 7$

Similarly,
 $(3)^4 - 1 = 81 - 1 = 80$
 $(3)^4 - 3 = 81 - 3 = 78$

In simple way, $9 - 2 = 7$ and $80 - 2 = 78$

121. (a) **Defer** means 'to delay something until a later time', 'to postpone'.

Put off means 'to put something to a later time or date', 'to delay'.

Thus, **Defer** and **Put off** are synonymous to one another.

Deduce means 'to infer', 'to arrive at facts'.

Infer means 'to arrive at a conclusion'.

122. (c) 'Gill' is the opening on the side of a fish's head through which it breathes.

'Nose' is the part of the face above the mouth, used for breathing and smelling.

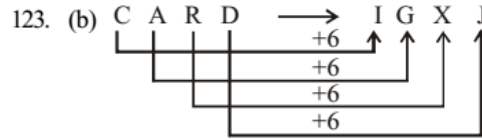

Similarly,

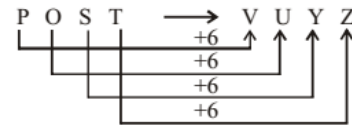

124. (b) Coffee is served in a cup and soup is served in a bowl.

125. (b) (Ink is used for pen and petrol is used for car)

126. (d) $M \xrightarrow{-3} J$ Similarly, $R \xrightarrow{-3} O$
 $A \xrightarrow{-3} X$ $U \xrightarrow{-3} R$
 $D \xrightarrow{-3} A$ $N \xrightarrow{-3} K$

127. (d) Place value of letter in English Alphabet.



Similarly,



128. (c) $8 \times 9 = 72$

Then, $39 \times 9 = \boxed{351}$

129. (d) $4^2 = 16$

$6^2 = 36$

$8^2 = 64$

$10^2 = \boxed{100}$

130. (a) A saint practices meditation.

Similarly,

A scientist does research.

131. (d) A palace is the official home of a King.

Similarly,

An igloo is a small round house of an Eskimo.

132. (c) $A \xrightarrow{+5} F \xrightarrow{+5} K \xrightarrow{+5} P$

$D \xrightarrow{+5} I \xrightarrow{+5} N \xrightarrow{+5} S$

$W \xrightarrow{+5} B \xrightarrow{+5} G \xrightarrow{+5} L$

$O \xrightarrow{+5} T \xrightarrow{+5} Y \xrightarrow{+5} D$

133. (c) $S \xrightarrow{-2} Q$ Similarly $M \xrightarrow{-2} K$

$I \xrightarrow{-2} G$

$O \xrightarrow{-2} M$

$N \xrightarrow{-2} L$

$N \xrightarrow{-2} L$

$G \xrightarrow{-2} E$

$S \xrightarrow{-2} Q$

$E \xrightarrow{-2} C$

$T \xrightarrow{-2} R$

$R \xrightarrow{-2} P$

$E \xrightarrow{-2} C$

$R \xrightarrow{-2} P$

134. (c) $18/3 - 1 = 5$
 $12/3 - 1 = \boxed{3}$

135. (d) $12 : 20 :: \boxed{30} : \boxed{42}$
 $(3 \times 4) \quad (4 \times 5) \quad (5 \times 6) \quad (6 \times 7)$

136. (b) $\frac{3}{7} = \frac{15}{x}$
 $3x = 15 \times 7$
 $x = \frac{15 \times 7}{3} = 35$

137. (b) Meghdoot has been written by Kalidas.
 Similarly,
 Arthashastra has been written by kautilya.

138. (d) Ocean is the mass of water.
 Similarly,
 Desert is the mass of sand.

139. (d) As, $A \xrightarrow{+2} C$ Similarly $X \xrightarrow{-2} V$
 $B \xrightarrow{+2} D$ $Y \xrightarrow{-2} W$
 $C \xrightarrow{+2} E$ $Z \xrightarrow{-2} X$

140. (c) Sea sickness is to feel ill when you are travelling on a ship or boat.

Similarly, Giddiness is to feel that you are going to fall.

141. (c) Waitress is a person whose job is to serve customers in a restaurant.

Similarly, A teacher teaches students in a school.

142. (a) $A \xrightarrow{R} O \xrightarrow{U} N \Rightarrow R A U O D N$
 Similarly,
 $G \xrightarrow{R} O \xrightarrow{U} N \Rightarrow R G U O D N$

143. (b) $\boxed{APP} R O A C H E D \Rightarrow R O A C H E D \boxed{APP}$
 Similarly,
 $\boxed{BAR} G A I N E D \Rightarrow G A I N E D \boxed{BAR}$

144. (c) $8 \times 8 = 64 \times 4 = 256$
 $10 \times 10 = 100 \times 5 = 500$

145. (b) $\frac{21}{3} = 7$

Similarly, $\frac{574}{x} = 7, x = \frac{574}{7} = 82$

146. (a) $S \xrightarrow{-5} N$ Similarly, $S \xrightarrow{-5} N$
 $I \xrightarrow{-5} D$ $O \xrightarrow{-5} J$
 $L \xrightarrow{-5} G$ $I \xrightarrow{-5} D$
 $K \xrightarrow{-5} F$ $L \xrightarrow{-5} G$

147. (a) $(7)^2 - 2 = 47$
 $(9)^2 - 2 = \boxed{79}$

148. (b) $A \xrightarrow{+1} B$ Similarly, $E \xrightarrow{+1} F$
 $C \xrightarrow{+1} D$ $G \xrightarrow{+1} H$
 $F \xrightarrow{+1} G$ $J \xrightarrow{+1} K$

149. (d) $A \xrightarrow{+6} G$ Similarly, $M \xrightarrow{+6} S$
 $C \xrightarrow{+6} I$ $O \xrightarrow{+6} U$
 $E \xrightarrow{+6} K$ $Q \xrightarrow{+6} W$
 $F \xrightarrow{+6} L$ $R \xrightarrow{+6} X$

150. (a) Oil is the fuel of lamp.
 Similarly, current is the fuel of electric bulb.

151. (b) A poet is a writer of a poem.
 Similarly,
 An author is a writer of a book.

152. (c) An optimist person looks upon the bright side of things, hence remains cheerful always.

Similarly, a pessimist person looks upon the dark side of things, hence remains gloomy always.

153. (d) $G H J M : Q R T W$
 $\downarrow \uparrow \downarrow \uparrow \downarrow \uparrow \downarrow \uparrow$
 $+1 +2 +3 +4 +1 +2 +3$
 Similarly,

$C D F I : \boxed{M N P S}$
 $\downarrow \uparrow \downarrow \uparrow \downarrow \uparrow \downarrow \uparrow$
 $+1 +2 +3 +4 +1 +2 +3$

154. (d) $C \xrightarrow{+1} D$ Similarly, $A \xrightarrow{+1} B$
 $I \xrightarrow{+1} J$ $G \xrightarrow{+1} H$
 $Q \xrightarrow{+1} R$ $O \xrightarrow{+1} P$
 $Y \xrightarrow{+1} Z$ $W \xrightarrow{+1} X$

155. (d) $C A F D : I G L J$
 $\downarrow \downarrow \downarrow \downarrow$
 $-2 -2 -2 -2$
 Similarly,

$O M R P : U S X V$
 $\downarrow \downarrow \downarrow \downarrow$
 $-2 -2 -2 -2$

156. (b) $(2)^3 = 8 \ \& \ (2+2)^3 = > (4)^3 = 64$

Similarly,
 $(3)^3 = 27 \ \& \ (3+2)^3 = > (5)^3 = 125$

157. (b) $(4)^2 + 4 = 20$

$(6)^2 + 6 = \boxed{42}$

158. (a) $3 \times 3 \times 3 = 27$
 $3 \times 3 = 9$

Similarly, $4 \times 4 \times 4 = 64, 4 \times 4 = \boxed{16}$

159. (d) A Yard is a larger measure than an inch. A quart is a larger measure than an ounce.

160. (c) A pesticide is a chemical preparation for protection of crop from insects. Similarly, an antiseptic is a chemical preparation for protection of wound from germs .

161. (a) $9 \times 3 - 3 = 24$
 $3 \times 3 - 3 = 6$
162. (d) A hive is a shelter for bees
 An eyrie is a large nest of an eagle.
163. (d) Letters are arranged in reverse order.

S T A R \longrightarrow R A T S

Similarly,

W A R D \longrightarrow D R A W

164. (d) Place value from the left end
- | | | | |
|-----|-----|-----|-----|
| D | C | B | A |
| (4) | (3) | (2) | (1) |
| ↓ | ↓ | ↓ | ↓ |
| W | X | Y | Z |
- Place value from the right end
- | | | | |
|-----|-----|-----|-----|
| (4) | (3) | (2) | (1) |
|-----|-----|-----|-----|
- Similarly,
- Place value from the left end
- | | | | |
|-----|------|------|------|
| I | J | K | L |
| (9) | (10) | (11) | (12) |
| ↓ | ↓ | ↓ | ↓ |
| R | Q | P | O |
- Place value from the right end
- | | | | |
|-----|------|------|------|
| (9) | (10) | (11) | (12) |
|-----|------|------|------|

165. (d) D H L P T X
 $\downarrow -2 \downarrow -2 \downarrow -2 \downarrow -3 \downarrow -2 \downarrow -2$
 B F J M R V

Similarly,

C G K O S W
 $\downarrow -2 \downarrow -2 \downarrow -2 \downarrow -3 \downarrow -2 \downarrow -2$
 A E I L Q U

166. (d) All numbers are prime.
167. (c) $6 \times 7 = 42$
 $5 \times 7 = 35$
 So, $6 : 42 :: 5 : 35$
168. (a) Hockey is national game of India in the same way baseball is national game of USA.
169. (b) Ant, fly and bee are insects while hamster, squirrel are rodents. Mouse is also a rodent.
170. (a) $(12)^2 : (12+1)$
 Similarly $(7)^2 : (7+1) = 8$

171. (b) A $\xrightarrow{+1}$ B $\xrightarrow{+2}$ D $\xrightarrow{+1}$ E
- G $\xrightarrow{+1}$ H $\xrightarrow{+2}$ J $\xrightarrow{+1}$ K
- M $\xrightarrow{+1}$ N $\xrightarrow{+2}$ P $\xrightarrow{+1}$ Q
- S $\xrightarrow{+1}$ T $\xrightarrow{+2}$ V $\xrightarrow{+1}$ W

172. (a) A $\xrightarrow{+2}$ C $\xrightarrow{+2}$ E
- G $\xrightarrow{+2}$ I $\xrightarrow{+2}$ K
- M $\xrightarrow{+2}$ O $\xrightarrow{+2}$ Q
- $\boxed{S} \xrightarrow{+2} \boxed{U} \xrightarrow{+2} \boxed{W}$

So SUW is the correct answer

173. (d) Arranging in reverse order

G N I D A E R
 $\swarrow \quad \searrow \quad \swarrow \quad \searrow \quad \swarrow \quad \searrow$
 R E A D I N G

Similarly,

N O I T U L O S
 $\swarrow \quad \searrow \quad \swarrow \quad \searrow \quad \swarrow \quad \searrow$
 S O L U T I O N

174. (d) Brick is a single unit of wall In the same way, cell is single unit of tissue.

175. (b) $21 : 3 \Rightarrow 7 : 1$
 $574 : 82 \Rightarrow 7 : 1$

176. (c) S U M O
 $\downarrow -3 \downarrow -3 \downarrow -3 \downarrow -3$
 P R J L
- T A X I
 $\downarrow -3 \downarrow -3 \downarrow -3 \downarrow -3$
 Q X U F

177. (b) Concord means agreement. Similarly, Discord means disagreement or conflict.

178. (b) Feminine means qualities or appearance of a woman Similarly, masculine means qualities or appearance of a man.

179. (c) $20 \times 2 + 2 = 42$
 Similarly $31 \times 2 + 2 = 64$

180. (c) P $\xrightarrow{+3}$ S

V $\xrightarrow{+3}$ Y

F $\xrightarrow{+3}$ I

L $\xrightarrow{+3}$ O

181. (a) Carpentry is a type of skill. Similarly, singing is type of talent.

182. (d) $\frac{1}{4} \div \frac{1}{2} = \frac{1}{8}$, $\frac{2}{3} \div \frac{1}{2} = \frac{1}{3}$

183. (a) K c a C
 $\swarrow \quad \searrow \quad \swarrow \quad \searrow$
 C a c K
- X g m F
 $\swarrow \quad \searrow \quad \swarrow \quad \searrow$
 F m g X

184. (d) (72, 66, 96) all three numbers are multiples of 3. Similarly (54, 57, 78) are also multiples of 3.

185. (d) $6 + \sqrt[3]{216} = 6 + \sqrt[3]{6 \times 6 \times 6}$
 $7 + \sqrt[3]{343} = 7 + \sqrt[3]{7 \times 7 \times 7}$
 $8 + \sqrt[3]{512} = 8 + \sqrt[3]{8 \times 8 \times 8}$

$$9 + \sqrt[3]{729} = 9 + \sqrt[3]{9 \times 9 \times 9}$$

$$\downarrow$$

$$10 + 10\sqrt[3]{10 \times 10 \times 10} = 10 + \sqrt[3]{1000}$$

186. (c) Haematology is the branch of medicine concerned with the study and prevention of diseases related to the blood.

Similarly, phycology is the scientific study of algae.

187. (c) A group of Lions is called a pride.

A group of Cats is called a clowder.

188. (a) M A N W A N
 $\downarrow +3 \downarrow +3 \downarrow +3$ Similarly, $\downarrow +3 \downarrow +3 \downarrow +3$
 P D Q Z D Q

189. (b) A E F J
 $\downarrow +10 \downarrow +10 \downarrow +10 \downarrow +10$
 K O P T

Similarly,

G K L P
 $\uparrow -10 \uparrow -10 \uparrow -10 \uparrow -10$
 Q U V Z

190. (a) $2^5 = 32$
 $3^5 = 243$

191. (c) D × H M × Q
 $\downarrow \downarrow$ Similarly, $\downarrow \downarrow$
 4 × 8 13 × 17
 Respective place value of letters in English alphabet.
 Hence, option (c) is the correct answer.

192. (b) B L O C K E D
 $\downarrow \downarrow \downarrow \downarrow \downarrow \downarrow$
 Y O L X P V W

Above word follows reverse order of alphabets.

Similarly,

L A U N N C H
 $\downarrow \downarrow \downarrow \downarrow \downarrow \downarrow$
 O Z F M M X S

193. (b) $\therefore 12 \times \frac{12}{2} = 72$
 $\therefore 8 \times \frac{8}{2} = 32$

194. (d) F I G
 $\swarrow -1 \searrow +1 \swarrow -1 \searrow +1 \swarrow -1 \searrow +1$
 E G H J F H
 Similarly,
 B I N
 $\swarrow -1 \searrow +1 \swarrow -1 \searrow +1 \swarrow -1 \searrow +1$
 A C H J M O

195. (c) $6 \times 6 + 6 = 42$
 $7 \times 7 + 7 = 56$

196. (d) The waste of the house is called garbage. Similarly, the impurities in the ore are called gangue.

197. (d) D B U C J H
 $\downarrow +1 \downarrow +3 \downarrow +5$ Similarly, $\downarrow +1 \downarrow +3 \downarrow +5$
 E E Z D M M

198. (d) Pig lives in Sty In the same way, Dog lives in Kennel.

199. (b) B D G K A C F J : E G J N D F I M
 $\swarrow -1 \searrow -1 \swarrow -1 \searrow -1 \swarrow -1 \searrow -1$
 $\swarrow -1 \searrow -1 \swarrow -1 \searrow -1$

200. (b) 01 : 36 :: 02 :
 $(1 + 5)^2 = 36 \quad (2 + 5)^2 = 49$

201. (c) As length is measured in meter so power in watt.

202. (d) Z X V T : Y W U S
 $\swarrow -1 \searrow -1 \swarrow -1 \searrow -1$

R P N L : Q O M K
 $\swarrow -1 \searrow -1 \swarrow -1 \searrow -1$

203. (a) 42 : 20 :: 64 : 31
 $20 \times 2 + 2 = 42$
 $\therefore 31 \times 2 + 2 = 64$

204. (d) Cytology is study of Cell similarly Ornithology is study of bird.

205. (d) R I G T
 $+5 \downarrow -5 \downarrow -5 \downarrow +5 \downarrow$
 W D B Y
 F U S H
 $+5 \downarrow -5 \downarrow -5 \downarrow +5 \downarrow$
 K P N M

206. (b) $6 \times 7 = 42; 7 \times 8 = 56, \therefore 10 \times 11 = 110, 11 \times 12 = 132.$

207. (c) Medicine is given to patient. Similarly, Education is given to student.

208. (c) L A M P
 $-3 \downarrow -3 \downarrow -3 \downarrow -3 \downarrow$
 I X J M
 F I S H
 $-3 \downarrow -3 \downarrow -3 \downarrow -3 \downarrow$
 C F P E

209. (d) As, $20 = 13 \times 2 - 6$
 $\therefore 28 = 17 \times 2 - 6$

210. (a) Words in each pair are antonyms.

211. (d) As,
 A B D G : Z Y W T :: B C E H : Y X V S
 $\swarrow +1 \searrow +2 \swarrow +3 \swarrow -1 \searrow -2 \swarrow -3 \swarrow +1 \searrow +2 \swarrow +3 \swarrow -1 \searrow -2 \swarrow -3$
 So, Y X V S is correct.

212. (a) Modesty is the opposite of arrogance. Similarly, Debility is the opposite of strength.

213. (b) As, $6^2 + 7 = 43$
 $(7^2) + 8 = 57$
 Similarly,
 $(10)^2 + 11 = 111$
 $(11)^2 + 12 = 133$

214. (a) $A \xrightarrow{+2} C$ $E \xrightarrow{+2} G$
 $Z \xleftarrow{+2} X$ $V \xleftarrow{+2} T$
 $B \xrightarrow{+2} D$ $F \xrightarrow{+2} H$
 $Y \xleftarrow{+2} W$ $U \xleftarrow{+2} S$

215. (b) As,
 $2 \ 3 : 08 \ 27 :: 4 \ 5 : \boxed{64 \ 125}$

 So, 64125 is correct.

216. (d) As, Power is measured by Watt. Similarly, Work is measured by Joule.

217. (a) As,
 $N \ P \ B \ G$
 $+1\downarrow \ +1\downarrow \ +1\downarrow \ +1\downarrow$
 $O \ Q \ C \ H$

Similarly,
 $A \ J \ O \ T$
 $+1\downarrow \ +1\downarrow \ +1\downarrow \ +1\downarrow$
 $B \ K \ P \ U$

218. (c) As, $(101)^2 = 10201$
 Similarly, $(107)^2 = 11449$

219. (a) As the means of transport in 'Road' is 'Car', Similarly the means of transport on 'Water' is 'Ship'.

220. (b) As,
 $G \ L \ O \ W$
 $-1\downarrow \ -2\downarrow \ -1\downarrow \ -2\downarrow$
 $F \ J \ N \ U$

Similarly,
 $P \ T \ E \ L$
 $-1\downarrow \ -2\downarrow \ -1\downarrow \ -2\downarrow$
 $O \ R \ D \ J$

221. (a) As, $(5)^3 - 1 = 124$, Similarly, $(6)^3 - 1 = 215$

222. (b) As, Metre is a smaller unit of kilometre. Similarly, Kilogram is a smaller unit of Tonne.

223. (a)
 $A \ G \ N \ : \ I \ O \ V \ \dots \ B \ L \ M \ : \ \boxed{J \ T \ U}$

224. (c) As,
 $9143 \Rightarrow 9 + 1 + 4 + 3 = 17$
 $9963 \Rightarrow 9 + 9 + 6 + 3 = 27$

Similarly,
 $6731 \Rightarrow 6 + 7 + 3 + 1 = 17$
 $8964 \Rightarrow 8 + 9 + 6 + 4 = 27$

225. (c) As, Fire will burn
 Similarly, Ice will freeze.

226. (d) As,

Similarly,

227. (b) As, $(3)^3 = 27$ Similarly, $(4)^3 = 64$.

228. (b) Sound of horse is neigh. Similarly, Sound of elephant is trumpet.

229. (c) According to alphabetical order :

G	H		R	S
G	H		R	S
↓	↓	Similarly,	↓	↓
7	8		18	19

230. (c) $\begin{matrix} C & A & B \\ \swarrow & \downarrow & \searrow \\ R & A & C \end{matrix}$ Reverse Order

Similarly,
 $\begin{matrix} T & Y & R & E \\ \swarrow & \downarrow & \searrow & \swarrow \\ E & R & Y & T \end{matrix}$ Revers Order

231. (d) $12 \times 5 = 60$
 $28 \times 5 = 140$.

232. (c) According to question,

As, $\begin{matrix} \curvearrowright & \curvearrowright & \curvearrowright \\ R & A & T & E \\ \curvearrowleft & \curvearrowleft & \curvearrowleft \end{matrix} \longrightarrow EATR$
 Similarly, $\begin{matrix} \curvearrowright & \curvearrowright & \curvearrowright \\ S & E & A & T \\ \curvearrowleft & \curvearrowleft & \curvearrowleft \end{matrix} \longrightarrow TEAS$

233. (c) As, Book is a part of literature. Similarly, Song is a part of music.

234. (c) As, $\frac{21}{3} = 7$

Similarly, $\frac{574}{82} = 7$

235. (c) As, opposite word of 'giant' is 'dwarf' Similarly, opposite word of 'idiot' is 'genius'.

236. (b) As, Infuenza is caused by virus. Similarly, Ring worm is caused by Fungi.

237. (d) As, Blade is a part of fan Similarly, Chapter is a part of book.

238. (c) As,

L S F W
 $+2 \downarrow +1 \downarrow +2 \downarrow +1 \downarrow$
 N T H X

Similarly,

P K W E
 $+2 \downarrow +1 \downarrow +2 \downarrow +1 \downarrow$
 R L Y F

239. (a) As,

L M N O
 $+2 \downarrow +4 \downarrow +6 \downarrow +8 \downarrow$
 N Q T W

Similarly,

G H I J
 $+2 \downarrow +4 \downarrow +6 \downarrow +8 \downarrow$
 I L O R

240. (b) As, $(11)^2 - 1 \Rightarrow 121 - 1 = 120$

Similarly, $(13)^2 - 1$

$\Rightarrow 169 - 1 = 168$

241. (c) As, $(103)^2 = 10609$ Similarly, $(106)^2 = 11236$

242. (a) According to pattern, $(11)^2 = 121$

Similarly, $(12)^2 = 144$

243. (a) As, $(15 + 1)^2 = (16)^2 = 256$

Similarly,

$(14 + 1)^2 = (15)^2 = 225.$

244. (a) As,

$(108)^2 = 11664$

Similarly,

$(107)^2 = 11449.$

245. (a) As,

C H A R G E R
 $+1 \downarrow -1 \downarrow +1 \downarrow -1 \downarrow +1 \downarrow -1 \downarrow +1 \downarrow$
 D G B Q H D S

Similarly,

C E L L U L A R
 $+1 \downarrow -1 \downarrow +1 \downarrow -1 \downarrow +1 \downarrow -1 \downarrow +1 \downarrow -1 \downarrow$
 D D M K V K B Q

246. (a) As,

R O M E
 $-1 \downarrow -1 \downarrow -1 \downarrow -1 \downarrow$
 Q N L D

Similarly,

M O R E
 $-1 \downarrow -1 \downarrow -1 \downarrow -1 \downarrow$
 L N Q D

247. (a) As,

C H A N N E L
 $\downarrow \downarrow \downarrow \downarrow \downarrow \downarrow \downarrow$
 X S Z M M V O

Similarly,

M U S I C A L
 $\downarrow \downarrow \downarrow \downarrow \downarrow \downarrow \downarrow$
 N F H R X Z O

248. (b) As, Rain is produced by clouds

Similarly, Heat is produced by Sun.

249. (b) As, Plants is related to garden.

Similarly,

Pages is related to book.

250. (b) As, Patient is cared by doctor

Similarly, Student is taught by teacher.

251. (d) As winter is a season like that April is a month.

252. (c)

12 : 68 :: 21 : 119
 $\downarrow \quad \downarrow \quad \downarrow \quad \downarrow$
 $\diamond 17/3 \quad \quad \quad \diamond 17/3$

253. (b)

12 : 192 :: 15 : 240
 $\downarrow \quad \downarrow \quad \downarrow \quad \downarrow$
 $\diamond 16 \quad \quad \quad \diamond 16$

254. (b) Dirty and Filthy are Similar word like that Shy and timid are similar word.

255. (d) Heart function is to circulated blood mix with oxygen into different parts of the body, like that kidney function is excretion of wastes from the body.

256. (a) An operator is one who operator and control the machine like that a driver is one who drive and control the car.

257. (c) (64, 100, 328)
 $\downarrow \quad \downarrow \quad \downarrow$
 $(8)^2 \quad (10)^2 \quad (8 + 10)^2 + 4$

Similarly

(25, 49, 148)
 $\downarrow \quad \downarrow \quad \downarrow$
 $(5)^2 \quad (7)^2 \quad (5 + 7)^2 + 4$

258. (d) In the given set,
 $(45, 49, 47) = 45 + 49 + 47 = 141.$

Now from option

(a) $(25, 54, 79) = 25 + 54 + 79 = 158$

(b) $(15, 19, 37) = 15 + 19 + 37 = 71$

(c) $(5, 39, 44) = 5 + 39 + 44 = 88$

(d) $(35, 59, 47) = 35 + 59 + 47 = 141$

Hence, option (d) is correct.

259. (d) PM : UT :: RU : WB
 $\downarrow \quad \downarrow \quad \downarrow \quad \downarrow$
 $+5 \quad \quad \quad +5$
 $\downarrow \quad \downarrow \quad \downarrow \quad \downarrow$
 $+7 \quad \quad \quad +7$

260. (d) 42 : 56 :: 12 : 20
 $\downarrow \quad \downarrow \quad \downarrow \quad \downarrow$
 $6 \times 7 \quad 7 \times 8 \quad \quad \quad 3 \times 4 \quad 4 \times 5$

261. (c) We use to cut out hair by trimming like that, we do cut the shrub by prune.
 262. (c) As, pain is caused by disease. Similarly, Injury is caused by accident.
 263. (c) As, $(13 \times 2) - 2 = 24$
 Similarly, $(20 \times 2) - 2 = 38$.
 264. (b) As bird has wings which helps it to fly.
 Similarly, Fish has fins which helps it to swim.
 265. (a)
 266. (c) As, $(6)^2 - 1 = 35$
 Similarly, $(9)^2 - 1 = 80$.
 267. (b) As,

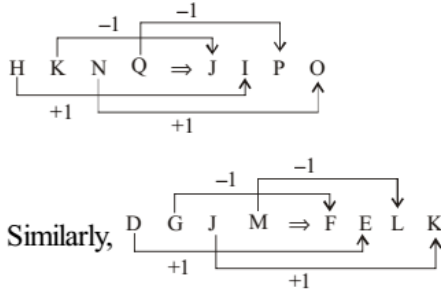

268. (d) As, small is denoted by dimension
 Similarly, Heavy is denoted by weight.
 269. (d) As,

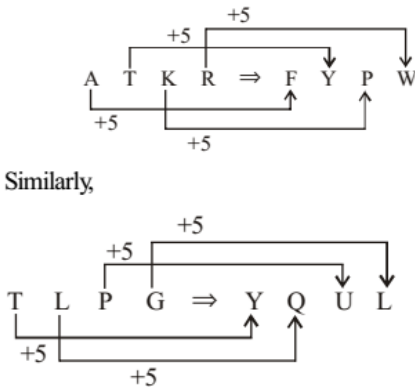

270. (c)
 271. (d) As, the distance round a circle is called circumference.
 Similarly, the distance round a rectangle is called perimeter.
 272. (c) The correct meaningful order :

273. (a)
 274. (c) As, V E G T \Rightarrow S H J Q

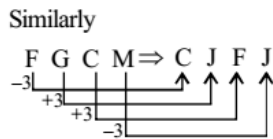

- Similarly
 F G C M \Rightarrow C J F J

275. (d) As, Chlorine is belong to Halogen. Similarly Neon is an Inert gas.
 276. (d) Jurist is the one related to law. Similarly orator is the related to speech.
 277. (a) The pattern is
 $[1 \times (1 + 1)] + 2 = 4$
 $[3 \times (3 + 1)] + 2 = 14$
 $[5 \times (5 + 1)] + 2 = 32$
 $[7 \times (7 + 1)] + 2 = 58$
 278. (b) As, Grief is synonyms of Anguish.
 Similarly, Pique is synonyms of Anger.

279. (d) $45 \times 3 = 135$
 $60 \times 3 = 180$
 280. (b) $56 \div 8 = 7$
 $91 \div 13 = 7$
 281. (a) As, (269, 278, 296)
 $269 \Rightarrow 2 + 6 + 9 = 17$
 $278 \Rightarrow 2 + 7 + 8 = 17$
 $296 \Rightarrow 2 + 9 + 6 = 17$
 Similarly, (313, 322, 340)
 $313 \Rightarrow 3 + 1 + 3 = 7$
 $322 \Rightarrow 3 + 2 + 2 = 7$
 $340 \Rightarrow 3 + 4 + 0 = 7$

282. (a) As, medicine is used by disease person. Similarly, food is used by hunger person.

283. (a) As, $12 \times \frac{12}{2} = 72$, $22 \times \frac{22}{2} = 242$
 Similarly, $18 \times \frac{18}{2} = 162$
 284. (a) As, clock is a device used to measure time. Similarly, Ammeter is a measuring instrument used to measure the current.

285. (c) The pattern is as —
 $35 + 31 = 66$
 $29 + 31 = 60$
 286. (a) As, Pentagon has five sides. Similarly, Rectangle has four sides
 287. (a) As, Red is related colour, Similarly Lawyer is related to Profession.

288. (a) As, J T N X

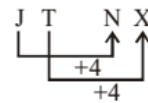

289. (b) As $34 \times 6 + 6 = 210$
 Similarly, $66 \times 6 + 6 = 402$.
 290. (d) As, (5, 6, 61)
 $5 + 6 = 61$
 Now,
 $5^2 + 6^2 = 25 + 36 = 61$
 Similarly, (3, 4, 25)
 $3 + 4 = 25$
 Now,
 $3^2 + 4^2 = 9 + 16 = 25$

291. (a) As,

E A S Y
 +1↓ +1↓
 I E T Z

Code for E → I
 Code for A → E
 Similarly,

L A K E
 +1↓ +1↓
 M E L I

Code for E → I
 Code for A → E

292. (a) As, (9, 217, 8)
 $9 \times 8 \Rightarrow 72 \times 3 + 1 = 217$
 Similarly, (4, 37, 3)
 $4 \times 3 = 12 \times 3 + 1 = 37$

293. (c) Except option (c) 6-35, rest three have same pattern to follow - (1st term)² + 1.
 Hence, (6 - 35) is different from the rest.

294. (c) As,

L A M E
 +3↓ -3↓ +3↓ -3↓
 O X P B

Similarly,

T R E E
 +3↓ -3↓ +3↓ -3↓
 W O H B

295. (c) As, in Graphology, we study about handwriting.
 Similarly, in Physics, we study about matter.

296. (a) The Pattern is as -
 $4 \times 3 + 1 = 13$
 $6 \times 3 + 1 = 19$
 and $5 \times 3 + 1 = 16$

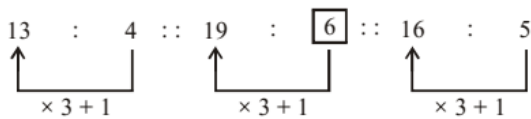

297. (a) As,

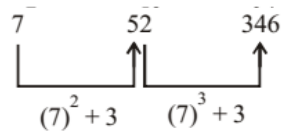

Similarly,

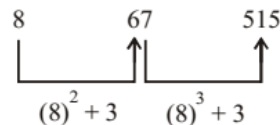

298. (b) As, Nascent is synonyms of young.
 Similarly, Adjunct is synonyms of Supportive.

299. (d) As, $14 = 7 \times 2$

$18 = 6 \times 3$
 $42 = 7 \times 6$

Similarly,

$16 = 8 \times 2$
 $21 = 7 \times 3$
 $56 = 8 \times 7$

300. (a) Pattern is,

$11^2 + 6 = 121 + 6 = 127$
 $19^2 + 6 = 361 + 6 = 367$

Similarly,

$16^2 + 6 = 256 + 6 = 262 = ?$

301. (c) As East is one of directions, similarly Summer is one of Seasons.

302. (b) As, (2, 3, 62) Similarly, (7, 4, 226)

303. (a) As, $A \xrightarrow{+6} G$

$Z \xrightarrow{+6} F$
 $W \xrightarrow{+6} C$

Similarly,

$L \xrightarrow{+6} R$
 $S \xrightarrow{+6} Y$
 $M \xrightarrow{+6} S$

304. (d) Stars study called 'Astronomy', similarly coins study called 'Numismatics'.

305. (a) 'Exhausted' is synonyms of 'Tired'. Similarly 'Depressed' is synonyms of 'Sad'.

306. (c) As 'Hydrometer' used for measuring 'Density'. Similarly 'Balance' used for measuring 'Mass'.

307. (d) As,
 $425 \rightarrow 4 + 2 + 5 = 11$
 $902 \rightarrow 9 + 0 + 2 = 11$
 $713 \rightarrow 7 + 1 + 3 = 11$
 Similarly,
 $218 \rightarrow 2 + 1 + 8 = 11.$

308. (c) As,
 $2 + 0 = 2$ and $8 - 6 = 2$
 Similarly,
 $1 + 2 = 3$ and $3 - 0 = 3$
 or

As,
 $6 + 8 = 14 = 1 + 4 = 5 \rightarrow \frac{20}{5} = 4$
 Similarly, $3 + 0 = 3 \rightarrow \frac{12}{3} = 4$

309. (d) As,

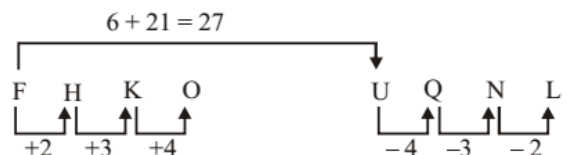

Similarly,

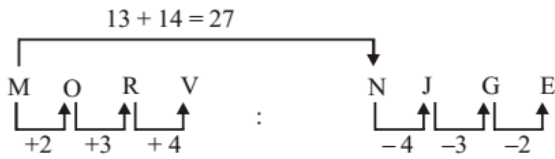

310. (b) $14 \times 10 + 14 \times \frac{14}{2}$
 $140 + 98 = 238$

Similarly, $18 \times 10 + 18 \times \frac{18}{2}$
 $180 + 162 = 342$

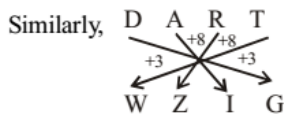
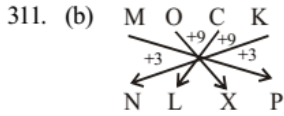

312. (c) $(13, 4, 18) = 13 - 4 = 9 = 9 \times 2 = 18$
 $(49, 24, 50) = 49 - 24 = 25 = 25 \times 2 = 50$
 $(87, 51, ?) = 87 - 51 = 36 = 36 \times 2 = 72$

313. (d) FRAGILE : RLIGFEA
 Letters arrange in alphabetical order
 Similarly,
 CAUTION : UTONICA

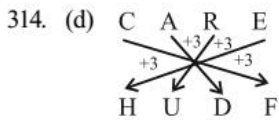

Similarly,

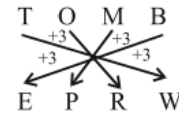

315. (b) Given,

$16 : 224$
 $16 \times (16 - 2)$

Similarly,
 $22 : 440$
 $22 \times (22 - 2)$

316. (c) As,



Similarly,



317. (a) As,

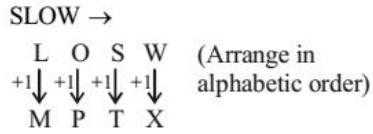

Similarly,

