

DATE : 05/05/2019

Test Booklet Code



Time : 3 hrs.

Answers & Solutions

for

NEET (UG) - 2019

Max. Marks : 720

Important Instructions :

1. The test is of **3 hours** duration and Test Booklet contains **180** questions. Each question carries **4** marks. For each correct response, the candidate will get **4** marks. For each incorrect response, **one mark** will be deducted from the total scores. The maximum marks are **720**.
2. Use **Blue / Black Ball point Pen only** for writing particulars on this page/marketing responses.
3. Rough work is to be done on the space provided for this purpose in the Test Booklet only.
4. On completion of the test, the candidate must handover the Answer Sheet to the Invigilator before leaving the Room / Hall. *The candidates are allowed to take away this Test Booklet with them.*
5. The CODE for this Booklet is **P2**.
6. The candidates should ensure that the Answer Sheet is not folded. Do not make any stray marks on the Answer Sheet. Do not write your Roll No. anywhere else except in the specified space in the Test Booklet/Answer Sheet.
7. Each candidate must show on demand his/her Admission Card to the Invigilator.
8. No candidate, without special permission of the Superintendent or Invigilator, would leave his/her seat.
9. Use of Electronic/Manual Calculator is prohibited.
10. The candidates are governed by all Rules and Regulations of the examination with regard to their conduct in the Examination Hall. All cases of unfair means will be dealt with as per Rules and Regulations of this examination.
11. No part of the Test Booklet and Answer Sheet shall be detached under any circumstances.
12. The candidates will write the Correct Test Booklet Code as given in the Test Booklet / Answer Sheet in the Attendance Sheet.

1. Under isothermal condition, a gas at 300 K expands from 0.1 L to 0.25 L against a constant external pressure of 2 bar. The work done by the gas is

(Given that 1 L bar = 100 J)

- (1) -30 J (2) 5 kJ
(3) 25 J (4) 30 J

Answer (1)

Sol. $\therefore W_{\text{irr}} = -P_{\text{ext}} \Delta V$
 $= -2 \text{ bar} \times (0.25 - 0.1) \text{ L}$
 $= -2 \times 0.15 \text{ L-bar}$
 $= -0.30 \text{ L-bar}$
 $= -0.30 \times 100 \text{ J}$
 $= -30 \text{ J}$

2. A compound is formed by cation C and anion A. The anions form hexagonal close packed (hcp) lattice and the cations occupy 75% of octahedral voids. The formula of the compound is :

- (1) C_2A_3
(2) C_3A_2
(3) C_3A_4
(4) C_4A_3

Answer (3)

- Sol.** • Anions(A) are in hcp, so number of anions (A) = 6
 Cations(C) are in 75% O.V., so number of cations (C)

$$= 6 \times \frac{3}{4}$$

$$= \frac{18}{4}$$

$$= \frac{9}{2}$$

- So formula of compound will be

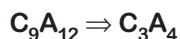
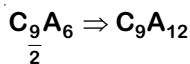

3. pH of a saturated solution of Ca(OH)_2 is 9. The solubility product (K_{sp}) of Ca(OH)_2 is:

- (1) 0.5×10^{-15} (2) 0.25×10^{-10}
(3) 0.125×10^{-15} (4) 0.5×10^{-10}

Answer (1)

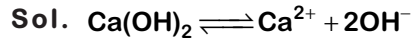

pH = 9 Hence pOH = 14 - 9 = 5
 $[\text{OH}^-] = 10^{-5} \text{ M}$

Hence $[\text{Ca}^{2+}] = \frac{10^{-5}}{2}$

Thus $K_{\text{sp}} = [\text{Ca}^{2+}][\text{OH}^-]^2$
 $= \left(\frac{10^{-5}}{2}\right)(10^{-5})^2$
 $= 0.5 \times 10^{-15}$

4. The number of moles of hydrogen molecules required to produce 20 moles of ammonia through Haber's process is :

- (1) 10 (2) 20
(3) 30 (4) 40

Answer (3)

Sol. Haber's process

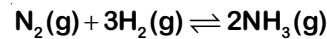

20 moles need to be produced

2 moles of $\text{NH}_3 \rightarrow 3$ moles of H_2

Hence 20 moles of $\text{NH}_3 \rightarrow \frac{3 \times 20}{2} = 30$ moles of H_2

5. For an ideal solution, the correct option is :

- (1) $\Delta_{\text{mix}} S = 0$ at constant T and P
(2) $\Delta_{\text{mix}} V \neq 0$ at constant T and P
(3) $\Delta_{\text{mix}} H = 0$ at constant T and P
(4) $\Delta_{\text{mix}} G = 0$ at constant T and P

Answer (3)

Sol. For ideal solution,

$$\Delta_{\text{mix}} H = 0$$

$$\Delta_{\text{mix}} S > 0$$

$$\Delta_{\text{mix}} G < 0$$

$$\Delta_{\text{mix}} V = 0$$

6. For a cell involving one electron $E^\circ_{\text{cell}} = 0.59 \text{ V}$ at 298 K, the equilibrium constant for the cell reaction is :

Given that $\frac{2.303 RT}{F} = 0.059 \text{ V at } T = 298 \text{ K}$

- (1) 1.0×10^2 (2) 1.0×10^5
(3) 1.0×10^{10} (4) 1.0×10^{30}

Answer (3)

Sol. $E_{\text{cell}} = E^{\circ}_{\text{cell}} - \frac{0.059}{n} \log Q \quad \dots(i)$

(At equilibrium, $Q = K_{\text{eq}}$ and $E_{\text{cell}} = 0$)

$0 = E^{\circ}_{\text{cell}} - \frac{0.059}{1} \log K_{\text{eq}}$ (from equation (i))

$\log K_{\text{eq}} = \frac{E^{\circ}_{\text{cell}}}{0.059} = \frac{0.59}{0.059} = 10$

$K_{\text{eq}} = 10^{10} = 1 \times 10^{10}$

7. Among the following, the one that is not a green house gas is

- (1) Nitrous oxide (2) Methane
(3) Ozone (4) Sulphur dioxide

Answer (4)

Sol. Fact

SO_2 (g) is not a greenhouse gas.

8. The number of sigma (σ) and pi (π) bonds in pent-2-en-4-yne is

- (1) 10σ bonds and 3π bonds
(2) 8σ bonds and 5π bonds
(3) 11σ bonds and 2π bonds
(4) 13σ bonds and no π bonds

Answer (1)

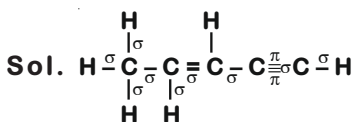

Number of σ bonds = 10

and number of π bonds = 3

9. Which of the following diatomic molecular species has only π bonds according to Molecular Orbital Theory?

- (1) O_2 (2) N_2
(3) C_2 (4) Be_2

Answer (3)

Sol. MO configuration C_2 is:

$\sigma 1s^2, \sigma^* 1s^2, \sigma 2s^2, \sigma^* 2s^2, \pi 2p_x^2 = \pi 2p_y^2$

10. Which of the following reactions are disproportionation reaction?

- (a) $2\text{Cu}^+ \longrightarrow \text{Cu}^{2+} + \text{Cu}^0$
(b) $3\text{MnO}_4^{2-} + 4\text{H}^+ \longrightarrow 2\text{MnO}_4^- + \text{MnO}_2 + 2\text{H}_2\text{O}$

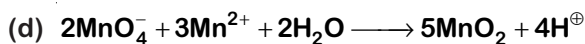
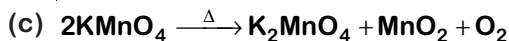

Select the correct option from the following

- (1) (a) and (b) only (2) (a), (b) and (c)
(3) (a), (c) and (d) (4) (a) and (d) only

Answer (1)

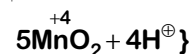
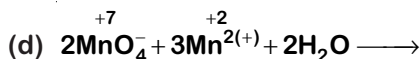
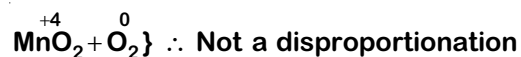
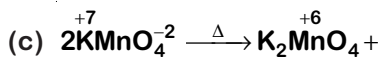
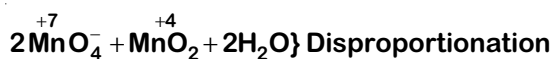
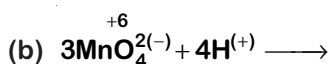
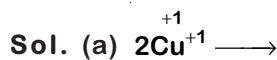

11. Among the following, the narrow spectrum antibiotic is :

- (1) Penicillin G
(2) Ampicillin
(3) Amoxycillin
(4) Chloramphenicol

Answer (1)

Sol. Penicillin G

12. The correct order of the basic strength of methyl substituted amines in aqueous solution is :

- (1) $(\text{CH}_3)_2\text{NH} > \text{CH}_3\text{NH}_2 > (\text{CH}_3)_3\text{N}$
(2) $(\text{CH}_3)_3\text{N} > \text{CH}_3\text{NH}_2 > (\text{CH}_3)_2\text{NH}$
(3) $(\text{CH}_3)_3\text{N} > (\text{CH}_3)_2\text{NH} > \text{CH}_3\text{NH}_2$
(4) $\text{CH}_3\text{NH}_2 > (\text{CH}_3)_2\text{NH} > (\text{CH}_3)_3\text{N}$

Answer (1)

Sol. In aqueous solution, electron donating inductive effect, solvation effect (H-bonding) and steric hindrance all together affect basic strength of substituted amines

17. The most suitable reagent for the following conversion, is :

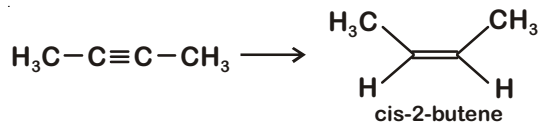

- (1) Na/liquid NH_3
- (2) H_2 , Pd/C, quinoline
- (3) Zn/HCl
- (4) $\text{Hg}^{2+}/\text{H}^+$, H_2O

Answer (2)

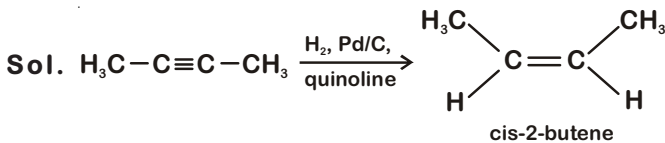

18. Which of the following species is not stable?

- (1) $[\text{SiF}_6]^{2-}$
- (2) $[\text{GeCl}_6]^{2-}$
- (3) $[\text{Sn}(\text{OH})_6]^{2-}$
- (4) $[\text{SiCl}_6]^{2-}$

Answer (4)

Sol. • Due to presence of d-orbital in Si, Ge and Sn they form species like SiF_6^{2-} , $[\text{GeCl}_6]^{2-}$, $[\text{Sn}(\text{OH})_6]^{2-}$

- SiCl_6^{2-} does not exist because six large chloride ions cannot be accommodated around Si^{4+} due to limitation of its size.

19. Which of the following is an amphoteric hydroxide?

- (1) $\text{Sr}(\text{OH})_2$
- (2) $\text{Ca}(\text{OH})_2$
- (3) $\text{Mg}(\text{OH})_2$
- (4) $\text{Be}(\text{OH})_2$

Answer (4)

Sol. $\text{Be}(\text{OH})_2$ amphoteric in nature, since it can react both with acid and base

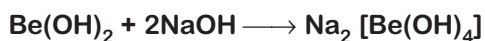

20. The structure of intermediate A in the following reaction, is

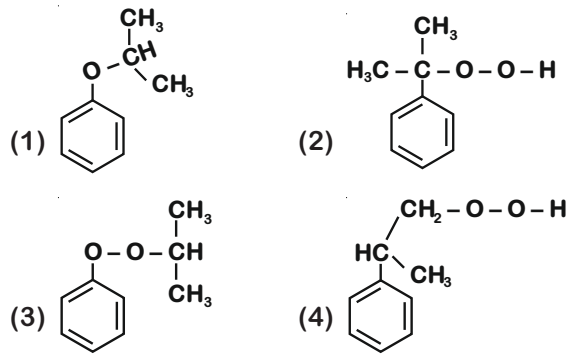
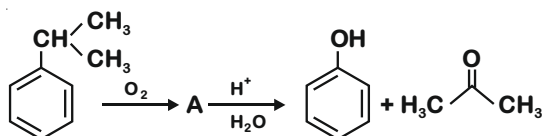

Answer (2)

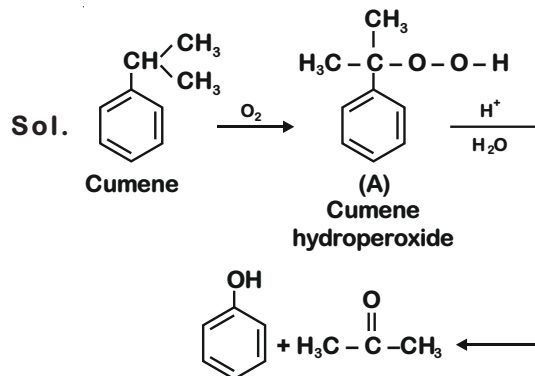

21. The manganate and permanganate ions are tetrahedral, due to :

- (1) The π -bonding involves overlap of p-orbitals of oxygen with d-orbitals of manganese
- (2) There is no π -bonding
- (3) The π -bonding involves overlap of p-orbitals of oxygen with p-orbitals of manganese
- (4) The π -bonding involves overlap of d-orbitals of oxygen with d-orbitals of manganese

Answer (1)

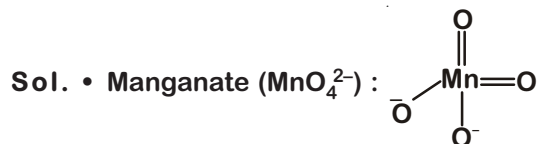

\Rightarrow π -bonds are of $d\pi-p\pi$ type

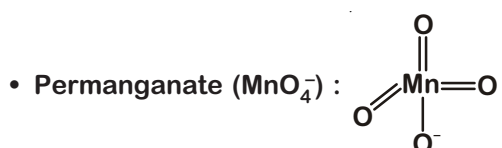

\Rightarrow π -bonds are of $d\pi-p\pi$ type

22. For the second period elements the correct increasing order of first ionisation enthalpy is:

- (1) $\text{Li} < \text{Be} < \text{B} < \text{C} < \text{N} < \text{O} < \text{F} < \text{Ne}$
- (2) $\text{Li} < \text{B} < \text{Be} < \text{C} < \text{O} < \text{N} < \text{F} < \text{Ne}$
- (3) $\text{Li} < \text{B} < \text{Be} < \text{C} < \text{N} < \text{O} < \text{F} < \text{Ne}$
- (4) $\text{Li} < \text{Be} < \text{B} < \text{C} < \text{O} < \text{N} < \text{F} < \text{Ne}$

Answer (2)

Sol. 'Be' and 'N' have comparatively more stable valence sub-shell than 'B' and 'O'.

∴ Correct order of first ionisation enthalpy is:



23. If the rate constant for a first order reaction is k , the time (t) required for the completion of 99% of the reaction is given by:

- (1) $t = 0.693/k$ (2) $t = 6.909/k$
- (3) $t = 4.606/k$ (4) $t = 2.303/k$

Answer (3)

Sol. First order rate constant is given as,

$$k = \frac{2.303}{t} \log \frac{[A]_0}{[A]_t}$$

99% completed reaction,

$$k = \frac{2.303}{t} \log \frac{100}{1}$$

$$= \frac{2.303}{t} \log 10^2$$

$$k = \frac{2.303}{t} \times 2 \log 10$$

$$t = \frac{2.303}{k} \times 2 = \frac{4.606}{k}$$

$$t = \frac{4.606}{k}$$

24. Identify the incorrect statement related to PCl_5 from the following:

- (1) Three equatorial P–Cl bonds make an angle of 120° with each other
- (2) Two axial P–Cl bonds make an angle of 180° with each other
- (3) Axial P–Cl bonds are longer than equatorial P–Cl bonds
- (4) PCl_5 molecule is non-reactive

Answer (4)

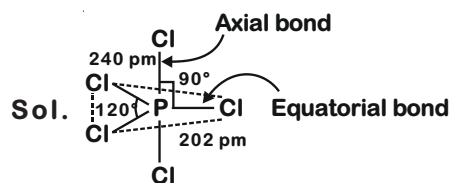

(1) True

(2) True

(3) True

Axial bond : 240 pm

Equatorial bond : 202 pm

(4) False

Due to longer and hence weaker axial bonds, PCl_5 is a reactive molecule.

25. 4d, 5p, 5f and 6p orbitals are arranged in the order of decreasing energy. The correct option is

- (1) $5f > 6p > 5p > 4d$ (2) $6p > 5f > 5p > 4d$
- (3) $6p > 5f > 4d > 5p$ (4) $5f > 6p > 4d > 5p$

Answer (1)

Sol. $(n + l)$ values for, $4d = 4 + 2 = 6$

$$5p = 5 + 1 = 6$$

$$5f = 5 + 3 = 8$$

$$6p = 6 + 1 = 7$$

∴ Correct order of energy would be

$$5f > 6p > 5p > 4d$$

26. The biodegradable polymer is:

- (1) Nylon-6,6 (2) Nylon-2-Nylon 6
- (3) Nylon-6 (4) Buna-S

Answer (2)

Sol. Nylon-2-Nylon 6

27. Match the Xenon compounds in Column-I with its structure in Column-II and assign the correct code:

Column-I	Column-II
(a) XeF_4	(i) Pyramidal
(b) XeF_6	(ii) Square planar
(c) XeOF_4	(iii) Distorted octahedral
(d) XeO_3	(iv) Square pyramidal

Code:

- | | | | |
|-----------|-------|-------|------|
| (a) | (b) | (c) | (d) |
| (1) (i) | (ii) | (iii) | (iv) |
| (2) (ii) | (iii) | (iv) | (i) |
| (3) (ii) | (iii) | (i) | (iv) |
| (4) (iii) | (iv) | (i) | (ii) |

Answer (2)

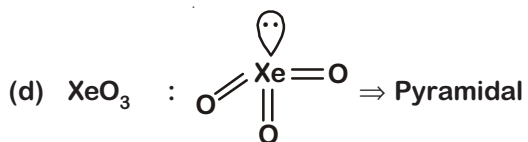
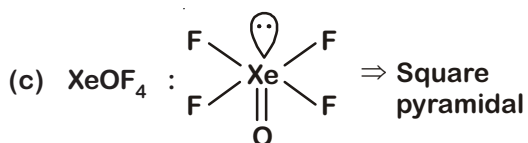
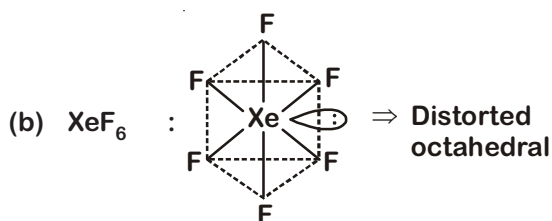
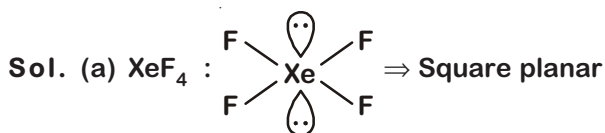

28. Which is the correct thermal stability order for H_2E (E = O, S, Se, Te and Po)?

- (1) $\text{H}_2\text{S} < \text{H}_2\text{O} < \text{H}_2\text{Se} < \text{H}_2\text{Te} < \text{H}_2\text{Po}$
- (2) $\text{H}_2\text{O} < \text{H}_2\text{S} < \text{H}_2\text{Se} < \text{H}_2\text{Te} < \text{H}_2\text{Po}$
- (3) $\text{H}_2\text{Po} < \text{H}_2\text{Te} < \text{H}_2\text{Se} < \text{H}_2\text{S} < \text{H}_2\text{O}$
- (4) $\text{H}_2\text{Se} < \text{H}_2\text{Te} < \text{H}_2\text{Po} < \text{H}_2\text{O} < \text{H}_2\text{S}$

Answer (3)

Sol. On going down the group thermal stability order for H_2E decreases because H-E bond energy decreases

\therefore Order of stability would be:-

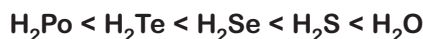

29. The correct structure of tribromooctaoxide is

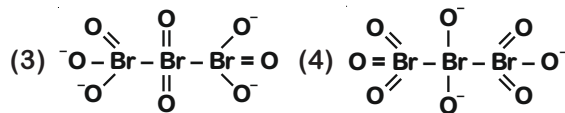
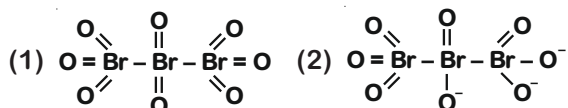

Answer (1)

Sol. The correct structure is

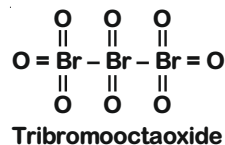

30. An alkene "A" on reaction with O_3 and $\text{Zn-H}_2\text{O}$ gives propanone and ethanal in equimolar ratio. Addition of HCl to alkene "A" gives "B" as the major product. The structure of product "B" is:

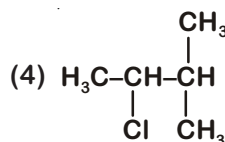
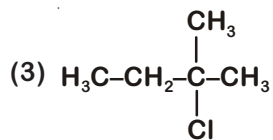
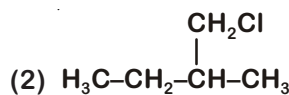
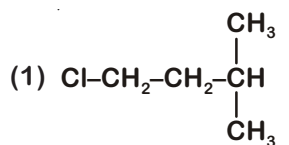

Answer (3)

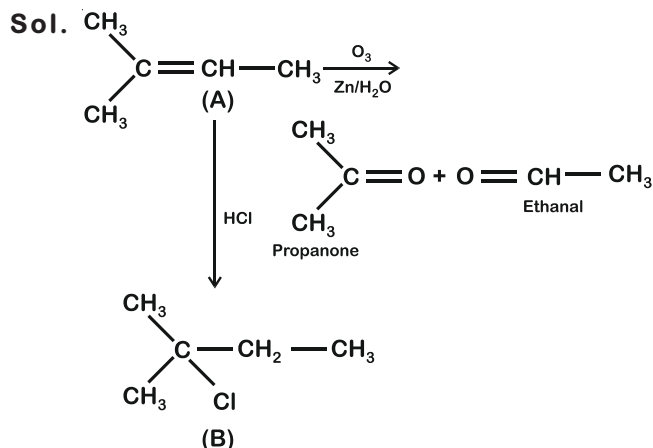

31. Enzymes that utilize ATP in phosphate transfer require an alkaline earth metal (M) as the cofactor. M is :

- (1) Be (2) Mg
(3) Ca (4) Sr

Answer (2)

Sol. All enzymes that utilize ATP in phosphate transfer require magnesium(Mg) as the co-factor.

32. Which one is malachite from the following?

- (1) CuFeS_2
(2) Cu(OH)_2
(3) Fe_3O_4
(4) $\text{CuCO}_3 \cdot \text{Cu(OH)}_2$

Answer (4)

Sol. Malachite : $\text{CuCO}_3 \cdot \text{Cu(OH)}_2$ (Green colour)

33. Which of the following series of transitions in the spectrum of hydrogen atom fall in visible region?

- (1) Lyman series
(2) Balmer series
(3) Paschen series
(4) Brackett series

Answer (2)

Sol. In H-spectrum, Balmer series transitions fall in visible region.

34. The mixture that forms maximum boiling azeotrope is:

- (1) Water + Nitric acid
(2) Ethanol + Water
(3) Acetone + Carbon disulphide
(4) Heptane + Octane

Answer (1)

Sol. Solutions showing negative deviation from Raoult's law form maximum boiling azeotrope

Water and Nitric acid \rightarrow forms maximum boiling azeotrope

35. For the cell reaction

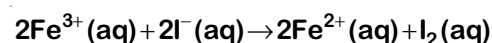

$E_{\text{cell}}^{\ominus} = 0.24 \text{ V}$ at 298 K. The standard Gibbs energy ($\Delta_r G^{\ominus}$) of the cell reaction is :

[Given that Faraday constant $F = 96500 \text{ C mol}^{-1}$]

- (1) $-46.32 \text{ kJ mol}^{-1}$ (2) $-23.16 \text{ kJ mol}^{-1}$
(3) $46.32 \text{ kJ mol}^{-1}$ (4) $23.16 \text{ kJ mol}^{-1}$

Answer (1)

Sol. $\Delta G^{\ominus} = -nF E_{\text{cell}}^{\ominus}$

$$= -2 \times 96500 \times 0.24 \text{ J mol}^{-1}$$

$$= -46320 \text{ J mol}^{-1}$$

$$= -46.32 \text{ kJ mol}^{-1}$$

36. In which case change in entropy is negative?

- (1) Evaporation of water
(2) Expansion of a gas at constant temperature
(3) Sublimation of solid to gas
(4) $2\text{H(g)} \rightarrow \text{H}_2(\text{g})$

Answer (4)

Sol. • $\text{H}_2\text{O}(\ell) \rightleftharpoons \text{H}_2\text{O}(\text{v}), \Delta S > 0$

- Expansion of gas at constant temperature, $\Delta S > 0$
- Sublimation of solid to gas, $\Delta S > 0$
- $2\text{H(g)} \rightarrow \text{H}_2(\text{g}), \Delta S < 0$ ($\because \Delta n_g < 0$)

37. Match the following :

- (a) Pure nitrogen (i) Chlorine
(b) Haber process (ii) Sulphuric acid
(c) Contact process (iii) Ammonia
(d) Deacon's process (iv) Sodium azide or Barium azide

Which of the following is the correct option?

- (a) (b) (c) (d)
(1) (i) (ii) (iii) (iv)
(2) (ii) (iv) (i) (iii)
(3) (iii) (iv) (ii) (i)
(4) (iv) (iii) (ii) (i)

Answer (4)

- Sol. (a) Pure nitrogen : Sodium azide or Barium azide
(b) Haber process : Ammonia
(c) Contact process : Sulphuric acid
(d) Deacon's process : Chlorine

38. Which of the following is incorrect statement?

- (1) PbF_4 is covalent in nature
- (2) SiCl_4 is easily hydrolysed
- (3) GeX_4 (X = F, Cl, Br, I) is more stable than GeX_2
- (4) SnF_4 is ionic in nature

Answer (1)

Sol. PbF_4 and SnF_4 are ionic in nature.

39. The non-essential amino acid among the following is:

- (1) Valine
- (2) Leucine
- (3) Alanine
- (4) Lysine

Answer (3)

Sol. Alanine

40. A gas at 350 K and 15 bar has molar volume 20 percent smaller than that for an ideal gas under the same conditions. The correct option about the gas and its compressibility factor (Z) is :

- (1) $Z > 1$ and attractive forces are dominant
- (2) $Z > 1$ and repulsive forces are dominant
- (3) $Z < 1$ and attractive forces are dominant
- (4) $Z < 1$ and repulsive forces are dominant

Answer (3)

Sol. • Compressibility factor (Z) = $\frac{V_{\text{real}}}{V_{\text{ideal}}}$

∴ $V_{\text{real}} < V_{\text{ideal}}$, Hence $Z < 1$

- If $Z < 1$, attractive forces are dominant among gaseous molecules and liquefaction of gas will be easy.

41. Among the following, the reaction that proceeds through an electrophilic substitution, is:

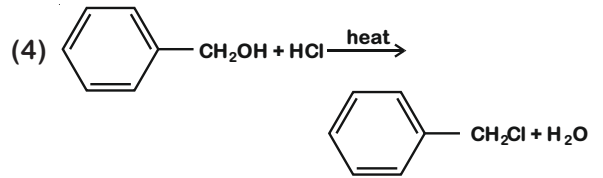
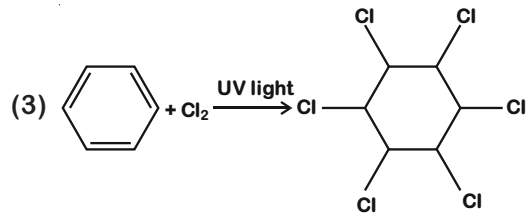
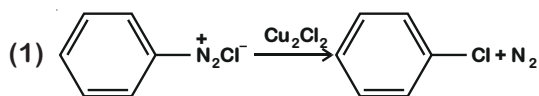

Answer (2)

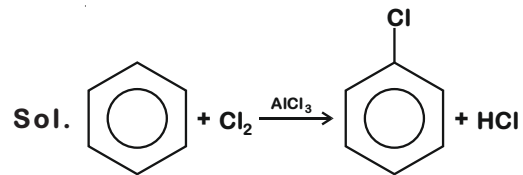

Generation of electrophile:

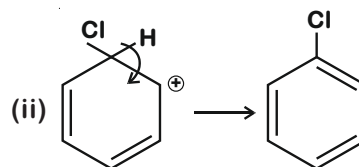
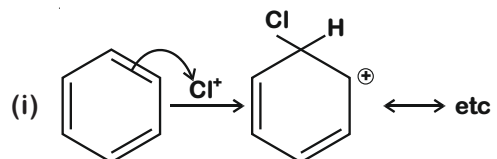
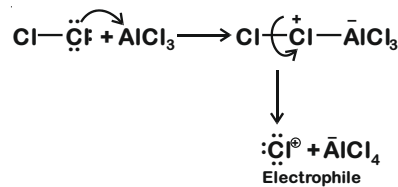

42. The major product of the following reaction is:

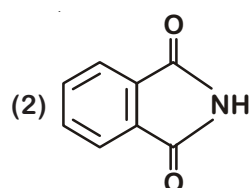
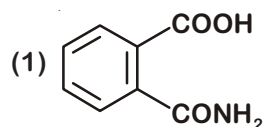
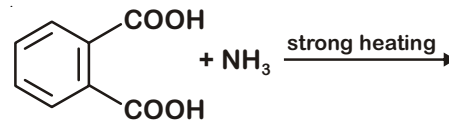

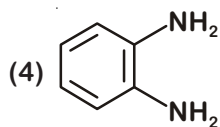
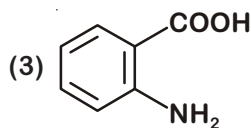

Answer (2)

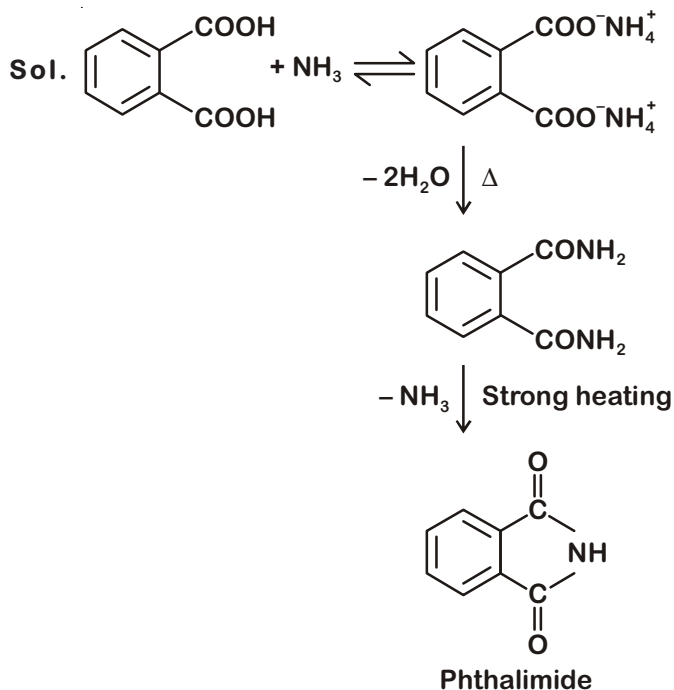

43. For the chemical reaction

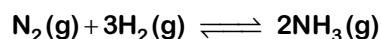

The correct option is:

(1) $-\frac{1}{3} \frac{d[\text{H}_2]}{dt} = -\frac{1}{2} \frac{d[\text{NH}_3]}{dt}$

(2) $-\frac{d[\text{N}_2]}{dt} = 2 \frac{d[\text{NH}_3]}{dt}$

(3) $-\frac{d[\text{N}_2]}{dt} = \frac{1}{2} \frac{d[\text{NH}_3]}{dt}$

(4) $3 \frac{d[\text{H}_2]}{dt} = 2 \frac{d[\text{NH}_3]}{dt}$

Answer (3)

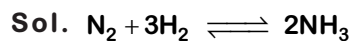

Rate of reaction is given as

$$-\frac{d[\text{N}_2]}{dt} = -\frac{1}{3} \frac{d[\text{H}_2]}{dt} = +\frac{1}{2} \frac{d[\text{NH}_3]}{dt}$$

44. What is the correct electronic configuration of the central atom in $\text{K}_4[\text{Fe}(\text{CN})_6]$ based on crystal field theory?

(1) $t_{2g}^4 e_g^2$

(2) $t_{2g}^6 e_g^0$

(3) $e^3 t_2^3$

(4) $e^4 t_2^2$

Answer (2)



Fe ground state: $[\text{Ar}]3d^6 4s^2$

Fe^{2+} : $3d^6 4s^0$

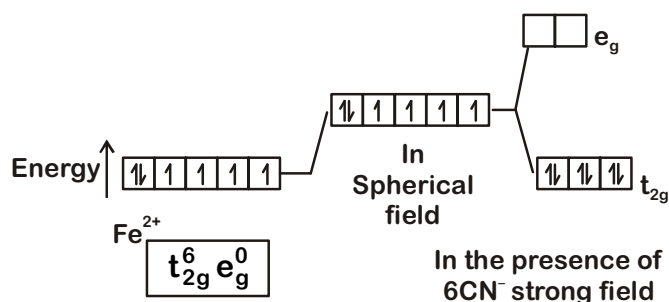

45. The method used to remove temporary hardness of water is :

(1) Calgon's method

(2) Clark's method

(3) Ion-exchange method

(4) Synthetic resins method

Answer (2)

Sol. Clark's method is used to remove temporary hardness of water, in which bicarbonates of calcium and magnesium are reacted with slaked lime $\text{Ca}(\text{OH})_2$

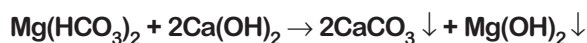
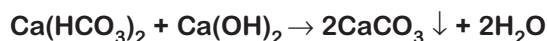

46. In which of the following processes, heat is neither absorbed nor released by a system?

- (1) Isothermal (2) Adiabatic
(3) Isobaric (4) Isochoric

Answer (2)

Sol. In adiabatic process, there is no exchange of heat.

47. Increase in temperature of a gas filled in a container would lead to :

- (1) Increase in its mass
(2) Increase in its kinetic energy
(3) Decrease in its pressure
(4) Decrease in intermolecular distance

Answer (2)

Sol. Increase in temperature would lead to the increase in kinetic energy of gas (assuming

far as to be ideal) as $U = \frac{F}{2} nRT$

48. The total energy of an electron in an atom in an orbit is -3.4 eV. Its kinetic and potential energies are, respectively:

- (1) -3.4 eV, -3.4 eV
(2) -3.4 eV, -6.8 eV
(3) 3.4 eV, -6.8 eV
(4) 3.4 eV, 3.4 eV

Answer (3)

Sol. In Bohr's model of H atom

$$\therefore \text{K.E.} = |TE| = \frac{|U|}{2}$$

$$\therefore \text{K.E.} = 3.4 \text{ eV}$$

$$U = -6.8 \text{ eV}$$

49.

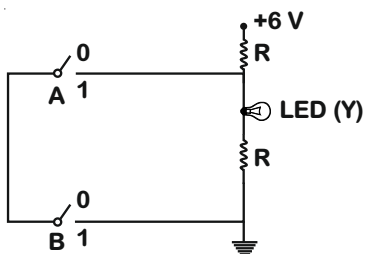

The correct Boolean operation represented by the circuit diagram drawn is :

- (1) AND (2) OR
(3) NAND (4) NOR

Answer (3)

Sol. From the given logic circuit LED will glow, when voltage across LED is high.

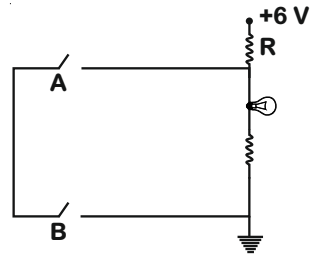

Truth Table

A	B	Y
0	0	1
0	1	1
1	0	1
1	1	0

This is out put of NAND gate.

50. A block of mass 10 kg is in contact against the inner wall of a hollow cylindrical drum of radius 1 m. The coefficient of friction between the block and the inner wall of the cylinder is 0.1 . The minimum angular velocity needed for the cylinder to keep the block stationary when the cylinder is vertical and rotating about its axis, will be : ($g = 10 \text{ m/s}^2$)

- (1) $\sqrt{10}$ rad/s (2) $\frac{10}{2\pi}$ rad/s
(3) 10 rad/s (4) 10π rad/s

Answer (3)

Sol.

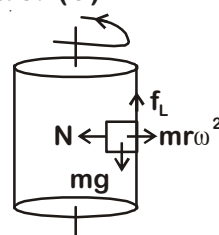

For equilibrium of the block limiting friction

$$f_L \geq mg$$

$$\Rightarrow \mu N \geq mg$$

$$\Rightarrow \mu m r \omega^2 \geq mg$$

$$\omega \geq \sqrt{\frac{g}{r\mu}}$$

$$\omega_{\min} = \sqrt{\frac{g}{r\mu}}$$

$$\omega_{\min} = \sqrt{\frac{10}{0.1 \times 1}} = 10 \text{ rad/s}$$

51. Body A of mass $4m$ moving with speed u collides with another body B of mass $2m$, at rest. The collision is head on and elastic in nature. After the collision the fraction of energy lost by the colliding body A is :

- (1) $\frac{1}{9}$ (2) $\frac{8}{9}$
 (3) $\frac{4}{9}$ (4) $\frac{5}{9}$

Answer (2)

Sol. Fractional loss of KE of colliding body

$$\frac{\Delta KE}{KE} = \frac{4(m_1 m_2)}{(m_1 + m_2)^2}$$

$$= \frac{4(4m)2m}{(4m + 2m)^2}$$

$$= \frac{32m^2}{36m^2} = \frac{8}{9}$$

52. The speed of a swimmer in still water is 20 m/s . The speed of river water is 10 m/s and is flowing due east. If he is standing on the south bank and wishes to cross the river along the shortest path, the angle at which he should make his strokes w.r.t. north is given by :

- (1) 30° west (2) 0°
 (3) 60° west (4) 45° west

Answer (1)

Sol. $V_{SR} = 20 \text{ m/s}$
 $V_{RG} = 10 \text{ m/s}$

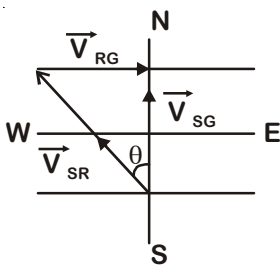

$$\vec{V}_{SG} = \vec{V}_{SR} + \vec{V}_{RG}$$

$$\sin \theta = \frac{|\vec{V}_{RG}|}{|\vec{V}_{SR}|}$$

$$\sin \theta = \frac{10}{20}$$

$$\sin \theta = \frac{1}{2}$$

$$\theta = 30^\circ \text{ west}$$

53. A mass m is attached to a thin wire and whirled in a vertical circle. The wire is most likely to break when:

- (1) The mass is at the highest point
 (2) The wire is horizontal
 (3) The mass is at the lowest point
 (4) Inclined at an angle of 60° from vertical

Answer (3)

Sol.

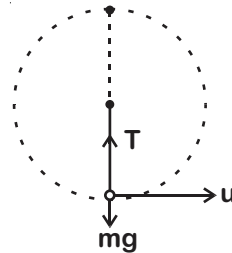

$$T - mg = \frac{mu^2}{l}$$

$$T = mg + \frac{mu^2}{l}$$

The tension is maximum at the lowest position of mass, so the chance of breaking is maximum.

54. The displacement of a particle executing simple harmonic motion is given by

$$y = A_0 + A \sin \omega t + B \cos \omega t$$

Then the amplitude of its oscillation is given by :

- (1) $A_0 + \sqrt{A^2 + B^2}$
 (2) $\sqrt{A^2 + B^2}$
 (3) $\sqrt{A_0^2 + (A+B)^2}$
 (4) $A + B$

Answer (2)

Sol.

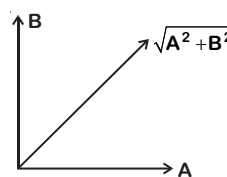

$$y = A_0 + A \sin \omega t + B \sin \omega t$$

Equate SHM

$$y' = y - A_0 = A \sin \omega t + B \cos \omega t$$

Resultant amplitude

$$R = \sqrt{A^2 + B^2 + 2AB \cos 90^\circ}$$

$$= \sqrt{A^2 + B^2}$$

55. A 800 turn coil of effective area 0.05 m^2 is kept perpendicular to a magnetic field $5 \times 10^{-5} \text{ T}$. When the plane of the coil is rotated by 90° around any of its coplanar axis in 0.1 s , the emf induced in the coil will be:

- (1) 2 V
 (2) 0.2 V
 (3) $2 \times 10^{-3} \text{ V}$
 (4) 0.02 V

Answer (4)

Sol. Magnetic field $B = 5 \times 10^{-5} \text{ T}$

Number of turns in coil $N = 800$

Area of coil $A = 0.05 \text{ m}^2$

Time taken to rotate $\Delta t = 0.1 \text{ s}$

Initial angle $\theta_1 = 0^\circ$

Final angle $\theta_2 = 90^\circ$

Change in magnetic flux $\Delta \phi$

$$= NBA \cos 90^\circ - BA \cos 0^\circ$$

$$= -NBA$$

$$= -800 \times 5 \times 10^{-5} \times 0.05$$

$$= -2 \times 10^{-3} \text{ weber}$$

$$e = -\frac{\Delta \phi}{\Delta t} = \frac{-(-)2 \times 10^{-3} \text{ Wb}}{0.1 \text{ s}} = 0.02 \text{ V}$$

56. Average velocity of a particle executing SHM in one complete vibration is :

- (1) $\frac{A\omega}{2}$
 (2) $A\omega$
 (3) $\frac{A\omega^2}{2}$
 (4) Zero

Answer (4)

Sol. In one complete vibration, displacement is zero. So, average velocity in one complete vibration

$$= \frac{\text{Displacement}}{\text{Time interval}} = \frac{y_f - y_i}{T} = 0$$

57. A soap bubble, having radius of 1 mm, is blown from a detergent solution having a surface tension of $2.5 \times 10^{-2} \text{ N/m}$. The pressure inside the bubble equals at a point Z_0 below the free surface of water in a container. Taking $g = 10 \text{ m/s}^2$, density of water = 10^3 kg/m^3 , the value of Z_0 is :

- (1) 100 cm
 (2) 10 cm
 (3) 1 cm
 (4) 0.5 cm

Answer (3)

Sol. Excess pressure = $\frac{4T}{R}$, Gauge pressure = $\rho g Z_0$

$$P_0 + \frac{4T}{R} = P_0 + \rho g Z_0$$

$$Z_0 = \frac{4T}{R \times \rho g}$$

$$Z_0 = \frac{4 \times 2.5 \times 10^{-2}}{10^{-3} \times 1000 \times 10} \text{ m}$$

$$Z_0 = 1 \text{ cm}$$

58. A copper rod of 88 cm and an aluminium rod of unknown length have their increase in length independent of increase in temperature. The length of aluminium rod is : ($\alpha_{\text{Cu}} = 1.7 \times 10^{-5} \text{ K}^{-1}$ and $\alpha_{\text{Al}} = 2.2 \times 10^{-5} \text{ K}^{-1}$)

- (1) 6.8 cm
 (2) 113.9 cm
 (3) 88 cm
 (4) 68 cm

Answer (4)

Sol. $\alpha_{\text{Cu}} L_{\text{Cu}} = \alpha_{\text{Al}} L_{\text{Al}}$

$$1.7 \times 10^{-5} \times 88 \text{ cm} = 2.2 \times 10^{-5} \times L_{\text{Al}}$$

$$L_{\text{Al}} = \frac{1.7 \times 88}{2.2} = 68 \text{ cm}$$

59. The unit of thermal conductivity is :

- (1) J m K^{-1}
 (2) $\text{J m}^{-1} \text{K}^{-1}$
 (3) W m K^{-1}
 (4) $\text{W m}^{-1} \text{K}^{-1}$

Answer (4)

Sol. The heat current related to difference of temperature across the length l of a conductor of area A is

$$\frac{dH}{dt} = \frac{KA}{\ell} \Delta T \quad (K = \text{coefficient of thermal conductivity})$$

$$\therefore K = \frac{\ell dH}{A dt \Delta T}$$

$$\text{Unit of } K = \text{Wm}^{-1} \text{K}^{-1}$$

60. When a block of mass M is suspended by a long wire of length L , the length of the wire becomes $(L + l)$. The elastic potential energy stored in the extended wire is :

- (1) Mgl (2) MgL
 (3) $\frac{1}{2}Mgl$ (4) $\frac{1}{2}MgL$

Answer (3)

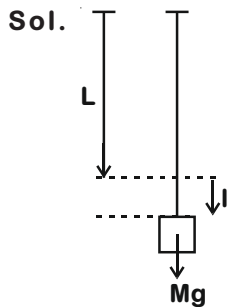

$$U = \frac{1}{2} (\text{work done by gravity})$$

$$U = \frac{1}{2}Mgl$$

61. A disc of radius 2 m and mass 100 kg rolls on a horizontal floor. Its centre of mass has speed of 20 cm/s. How much work is needed to stop it?

- (1) 3 J (2) 30 kJ
 (3) 2 J (4) 1 J

Answer (1)

Sol. Work required = change in kinetic energy

$$\text{Final KE} = 0$$

$$\text{Initial KE} = \frac{1}{2}mv^2 + \frac{1}{2}I\omega^2 = \frac{3}{4}mv^2$$

$$= \frac{3}{4} \times 100 \times (20 \times 10^{-2})^2 = 3 \text{ J}$$

$$|\Delta \text{KE}| = 3 \text{ J}$$

62. In an experiment, the percentage of error occurred in the measurement of physical quantities A, B, C and D are 1%, 2%, 3% and 4% respectively. Then the maximum percentage of

error in the measurement X, where $X = \frac{A^2 B^{\frac{1}{2}}}{C^{\frac{1}{3}} D^3}$,

will be

- (1) $\left(\frac{3}{13}\right)\%$ (2) 16%
 (3) - 10% (4) 10%

Answer (2)

Sol. Given

$$x = \frac{A^2 B^{\frac{1}{2}}}{C^{\frac{1}{3}} D^3}$$

$$\% \text{ error, } \frac{\Delta x}{x} \times 100 = 2 \frac{\Delta A}{A} \times 100 + \frac{1}{2} \frac{\Delta B}{B} \times$$

$$100 + \frac{1}{3} \frac{\Delta C}{C} \times 100 + 3 \frac{\Delta D}{D} \times 100$$

$$= 2 \times 1\% + \frac{1}{2} \times 2\% + \frac{1}{3} \times 3\% + 3 \times 4\%$$

$$= 2\% + 1\% + 1\% + 12\%$$

$$= 16\%$$

63. A body weighs 200 N on the surface of the earth. How much will it weigh half way down to the centre of the earth ?

- (1) 150 N (2) 200 N
 (3) 250 N (4) 100 N

Answer (4)

Sol.

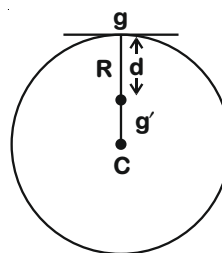

Acceleration due to gravity at a depth d from surface of earth

$$g' = g \left(1 - \frac{d}{R}\right) \dots (1)$$

Where g = acceleration due to gravity at earth's surface

Multiplying by mass ' m ' on both sides of (1)

$$mg' = mg \left(1 - \frac{d}{R}\right) \quad \left(d = \frac{R}{2}\right)$$

$$= 200 \left(1 - \frac{R}{2R}\right) = \frac{200}{2} = 100 \text{ N}$$

64. Which colour of the light has the longest wavelength?

- (1) Red (2) Blue
(3) Green (4) Violet

Answer (1)

Sol. Red has the longest wavelength among the given options.

65. A solid cylinder of mass 2 kg and radius 4 cm is rotating about its axis at the rate of 3 rpm. The torque required to stop after 2π revolutions is

- (1) 2×10^{-6} N m (2) 2×10^{-3} N m
(3) 12×10^{-4} N m (4) 2×10^6 N m

Answer (1)

Sol. Work energy theorem.

$$W = \frac{1}{2}I(\omega_f^2 - \omega_i^2) \quad \theta = 2\pi \text{ revolution}$$

$$= 2\pi \times 2\pi = 4\pi^2 \text{ rad}$$

$$W_i = 3 \times \frac{2\pi}{60} \text{ rad/s}$$

$$\Rightarrow -\tau\theta = \frac{1}{2} \times \frac{1}{2} m r^2 (\omega_f^2 - \omega_i^2)$$

$$\Rightarrow -\tau = \frac{\frac{1}{2} \times \frac{1}{2} \times 2 \times (4 \times 10^{-2})^2 \left(-3 \times \frac{2\pi}{60}\right)^2}{4\pi^2}$$

$$\Rightarrow \tau = 2 \times 10^{-6} \text{ Nm}$$

66. The radius of circle, the period of revolution, initial position and sense of revolution are indicated in the fig.

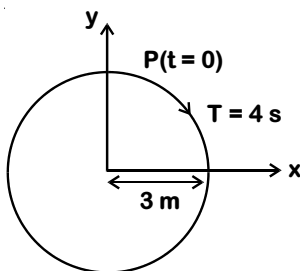

y - projection of the radius vector of rotating particle P is :

- (1) $y(t) = -3 \cos 2\pi t$, where y in m
(2) $y(t) = 4 \sin\left(\frac{\pi t}{2}\right)$, where y in m
(3) $y(t) = 3 \cos\left(\frac{3\pi t}{2}\right)$, where y in m
(4) $y(t) = 3 \cos\left(\frac{\pi t}{2}\right)$, where y in m

Answer (4)

Sol. At $t = 0$, y displacement is maximum, so equation will be cosine function.

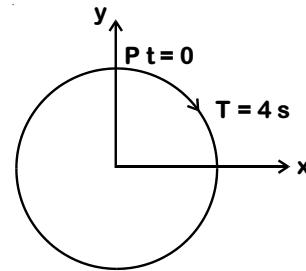

$$T = 4 \text{ s}$$

$$\omega = \frac{2\pi}{T} = \frac{2\pi}{4} = \frac{\pi}{2} \text{ rad/s}$$

$$y = a \cos \omega t$$

$$y = 3 \cos \frac{\pi t}{2}$$

67. A hollow metal sphere of radius R is uniformly charged. The electric field due to the sphere at a distance r from the centre

- (1) Increases as r increases for $r < R$ and for $r > R$
(2) Zero as r increases for $r < R$, decreases as r increases for $r > R$
(3) Zero as r increases for $r < R$, increases as r increases for $r > R$
(4) Decreases as r increases for $r < R$ and for $r > R$

Answer (2)

Sol.

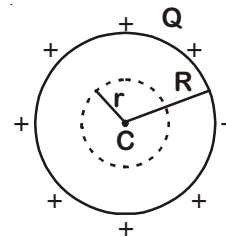

Charge Q will be distributed over the surface of hollow metal sphere.

(i) For $r < R$ (inside)

$$\text{By Gauss law, } \oint \vec{E}_{in} \cdot d\vec{S} = \frac{q_{en}}{\epsilon_0} = 0$$

$$\Rightarrow E_{in} = 0 \quad (\because q_{en} = 0)$$

(ii) For $r > R$ (outside)

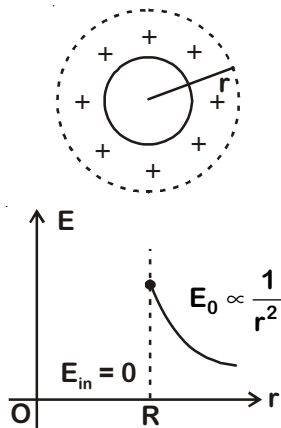

$$\oint \vec{E}_0 \cdot d\vec{S} = \frac{q_{en}}{\epsilon_0}$$

Here, $q_{en} = Q$ ($\because q_{en} = Q$)

$$\therefore E_0 4\pi r^2 = \frac{Q}{\epsilon_0}$$

$$\therefore E_0 \propto \frac{1}{r^2}$$

68. In which of the following devices, the eddy current effect is not used?

- (1) Induction furnace
- (2) Magnetic braking in train
- (3) Electromagnet
- (4) Electric heater

Answer (4)

Sol. Electric heater does not involve Eddy currents. It uses Joule's heating effect.

69. Six similar bulbs are connected as shown in the figure with a DC source of emf E and zero internal resistance.

The ratio of power consumption by the bulbs when (i) all are glowing and (ii) in the situation when two from section A and one from section B are glowing, will be :

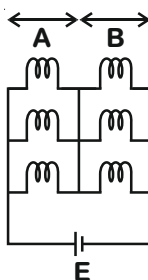

(1) 4 : 9

(2) 9 : 4

(3) 1 : 2

(4) 2 : 1

Answer (2)

Sol. (i) All bulbs are glowing

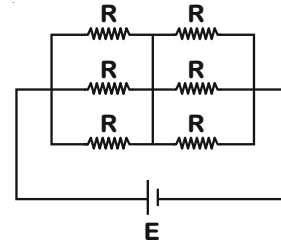

$$R_{eq} = \frac{R}{3} + \frac{R}{3} = \frac{2R}{3}$$

$$\text{Power } (P_i) = \frac{E^2}{R_{eq}} = \frac{3E^2}{2R} \quad \dots(1)$$

(ii) Two from section A and one from section B are glowing.

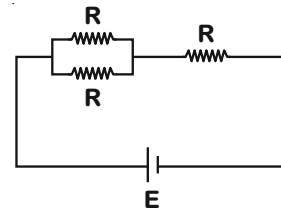

$$R_{eq} = \frac{R}{2} + R = \frac{3R}{2}$$

$$\text{Power } (P_f) = \frac{2E^2}{3R} \quad \dots(2)$$

$$\frac{P_i}{P_f} = \frac{3E^2}{2R} \frac{3R}{2E^2} = 9 : 4$$

70. At a point A on the earth's surface the angle of dip, $\delta = +25^\circ$. At a point B on the earth's surface the angle of dip, $\delta = -25^\circ$. We can interpret that:

- (1) A and B are both located in the northern hemisphere.
- (2) A is located in the southern hemisphere and B is located in the northern hemisphere.
- (3) A is located in the northern hemisphere and B is located in the southern hemisphere.
- (4) A and B are both located in the southern hemisphere.

Answer (3)

Sol. Angle of dip is the angle between earth's resultant magnetic field from horizontal. Dip is zero at equator and positive in northern hemisphere.

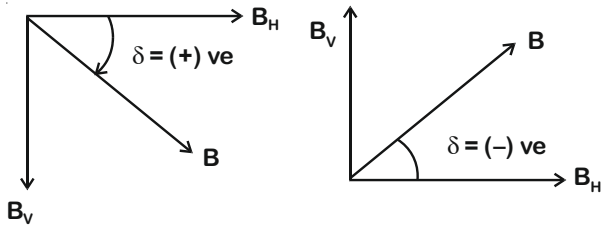

In southern hemisphere dip angle is considered as negative.

71. A force $F = 20 + 10y$ acts on a particle in y -direction where F is in newton and y in meter. Work done by this force to move the particle from $y = 0$ to $y = 1$ m is

- (1) 30 J (2) 5 J
 (3) 25 J (4) 20 J

Answer (3)

Sol. Work done by variable force is

$$W = \int_{y_i}^{y_f} F dy$$

Here, $y_i = 0$, $y_f = 1$ m

$$\therefore W = \int_0^1 (20 + 10y) dy = \left[20y + \frac{10y^2}{2} \right]_0^1 = 25 \text{ J}$$

72. Pick the wrong answer in the context with rainbow.

- (1) When the light rays undergo two internal reflections in a water drop, a secondary rainbow is formed
 (2) The order of colours is reversed in the secondary rainbow
 (3) An observer can see a rainbow when his front is towards the sun
 (4) Rainbow is a combined effect of dispersion refraction and reflection of sunlight

Answer (3)

Sol. Rainbow can't be observed when observer faces towards sun.

73. A cylindrical conductor of radius R is carrying a constant current. The plot of the magnitude of the magnetic field, B with the distance d from the centre of the conductor, is correctly represented by the figure :

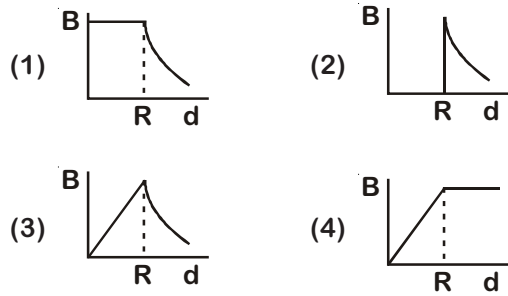

Answer (3)

Sol.

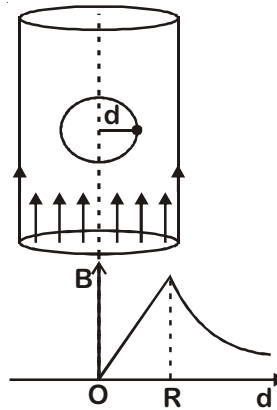

Inside ($d < R$)

Magnetic field inside conductor

$$B = \frac{\mu_0 i}{2\pi R^2} d$$

$$\text{or } B = Kd \quad \dots(i)$$

Straight line passing through origin

At surface ($d = R$)

$$B = \frac{\mu_0 i}{2\pi R} \quad \dots(ii)$$

Maximum at surface

Outside ($d > R$)

$$B = \frac{\mu_0 i}{2\pi d}$$

$$\text{or } B \propto \frac{1}{d} \text{ (Hyperbolic)}$$

74. Two particles A and B are moving in uniform circular motion in concentric circles of radii r_A and r_B with speed v_A and v_B respectively. Their time period of rotation is the same. The ratio of angular speed of A to that of B will be :

- (1) $r_A : r_B$ (2) $v_A : v_B$
 (3) $r_B : r_A$ (4) 1 : 1

Answer (4)

Sol.

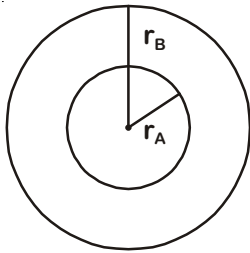

$$T_A = T_B = T$$

$$\omega_A = \frac{2\pi}{T_A}$$

$$\omega_B = \frac{2\pi}{T_B}$$

$$\frac{\omega_A}{\omega_B} = \frac{T_B}{T_A} = \frac{T}{T} = 1$$

75. Two similar thin equi-convex lenses, of focal length f each, are kept coaxially in contact with each other such that the focal length of the combination is F_1 . When the space between the two lenses is filled with glycerine (which has the same refractive index ($\mu = 1.5$) as that of glass) then the equivalent focal length is F_2 . The ratio $F_1 : F_2$ will be :

- (1) 2 : 1 (2) 1 : 2
 (3) 2 : 3 (4) 3 : 4

Answer (2)

Sol.

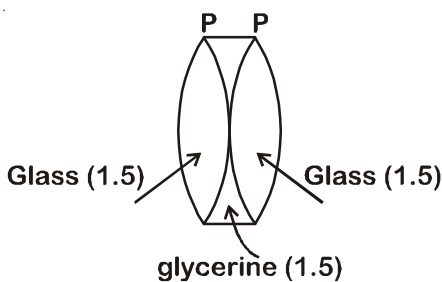
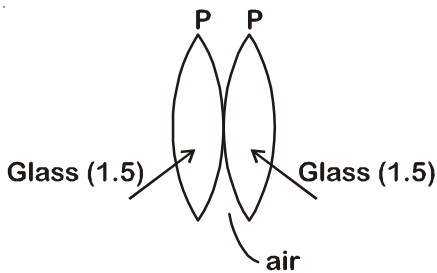

Equivalent focal length in air $\frac{1}{F_1} = \frac{1}{f} + \frac{1}{f} = \frac{2}{f}$

When glycerine is filled inside, glycerine lens behaves like a diverging lens of focal length $(-f)$

$$\frac{1}{F_2} = \frac{1}{f} + \frac{1}{f} - \frac{1}{f}$$

$$= \frac{1}{f}$$

$$\frac{F_1}{F_2} = \frac{1}{2}$$

76. In total internal reflection when the angle of incidence is equal to the critical angle for the pair of media in contact, what will be angle of refraction?

- (1) 180°
 (2) 0°
 (3) Equal to angle of incidence
 (4) 90°

Answer (4)

Sol.

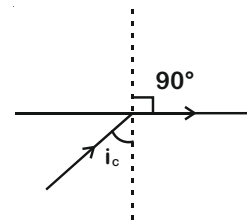

At $i = i_c$, refracted ray grazes with the surface.

So angle of refraction is 90° .

77. Two parallel infinite line charges with linear charge densities $+\lambda$ C/m and $-\lambda$ C/m are placed at a distance of $2R$ in free space. What is the electric field mid-way between the two line charges?

- (1) Zero (2) $\frac{2\lambda}{\pi\epsilon_0 R}$ N/C
 (3) $\frac{\lambda}{\pi\epsilon_0 R}$ N/C (4) $\frac{\lambda}{2\pi\epsilon_0 R}$ N/C

Answer (3)

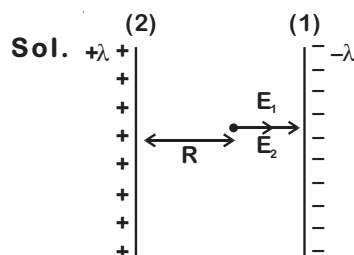

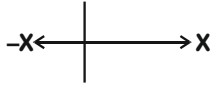

Electric field due to line charge (1)

$$\vec{E}_1 = \frac{\lambda}{2\pi\epsilon_0 R} \hat{i} \text{ N/C}$$

Electric field due to line charge (2)

$$\vec{E}_2 = \frac{\lambda}{2\pi\epsilon_0 R} \hat{i} \text{ N/C}$$

$$\begin{aligned} \vec{E}_{\text{net}} &= \vec{E}_1 + \vec{E}_2 \\ &= \frac{\lambda}{2\pi\epsilon_0 R} \hat{i} + \frac{\lambda}{2\pi\epsilon_0 R} \hat{i} \\ &= \frac{\lambda}{\pi\epsilon_0 R} \hat{i} \text{ N/C} \end{aligned}$$

78. For a p-type semiconductor, which of the following statements is true ?

- (1) Electrons are the majority carriers and trivalent atoms are the dopants.
- (2) Holes are the majority carriers and trivalent atoms are the dopants.
- (3) Holes are the majority carriers and pentavalent atoms are the dopants.
- (4) Electrons are the majority carriers and pentavalent atoms are the dopants.

Answer (2)

Sol. In p-type semiconductor, an intrinsic semiconductor is doped with trivalent impurities, that creates deficiencies of valence electrons called holes which are majority charge carriers.

79. Which of the following acts as a circuit protection device?

- (1) Conductor
- (2) Inductor
- (3) Switch
- (4) Fuse

Answer (4)

Sol. Fuse wire has less melting point so when excess current flows, due to heat produced in it, it melts.

80. A parallel plate capacitor of capacitance $20 \mu\text{F}$ is being charged by a voltage source whose potential is changing at the rate of 3 V/s . The conduction current through the connecting wires, and the displacement current through the plates of the capacitor, would be, respectively.

- (1) Zero, $60 \mu\text{A}$
- (2) $60 \mu\text{A}$, $60 \mu\text{A}$
- (3) $60 \mu\text{A}$, zero
- (4) Zero, zero

Answer (2)

Sol. Capacitance of capacitor $C = 20 \mu\text{F}$
 $= 20 \times 10^{-6} \text{ F}$

Rate of change of potential $\left(\frac{dV}{dt}\right) = 3 \text{ v/s}$

$$q = CV$$

$$\frac{dq}{dt} = C \frac{dV}{dt}$$

$$\begin{aligned} i_c &= 20 \times 10^{-6} \times 3 \\ &= 60 \times 10^{-6} \text{ A} \\ &= 60 \mu\text{A} \end{aligned}$$

As we know that $i_d = i_c = 60 \mu\text{A}$

81. In the circuits shown below, the readings of the voltmeters and the ammeters will be

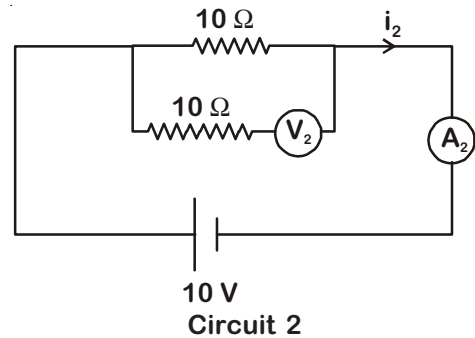
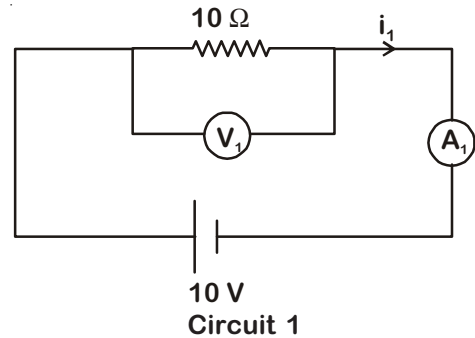

- (1) $V_2 > V_1$ and $i_1 = i_2$
- (2) $V_1 = V_2$ and $i_1 > i_2$
- (3) $V_1 = V_2$ and $i_1 = i_2$
- (4) $V_2 > V_1$ and $i_1 > i_2$

Answer (3)

Sol. For ideal voltmeter, resistance is infinite and for the ideal ammeter, resistance is zero.

$$V_1 = i_1 \times 10 = \frac{10}{10} \times 10 = 10 \text{ volt}$$

$$V_2 = i_2 \times 10 = \frac{10}{10} \times 10 = 10 \text{ volt}$$

$$V_1 = V_2$$

$$i_1 = i_2 = \frac{10 \text{ V}}{10 \Omega} = 1 \text{ A}$$

82. α -particle consists of :

- (1) 2 protons and 2 neutrons only
- (2) 2 electrons, 2 protons and 2 neutrons
- (3) 2 electrons and 4 protons only
- (4) 2 protons only

Answer (1)

Sol. α -particle is nucleus of Helium which has two protons and two neutrons.

83. An electron is accelerated through a potential difference of 10,000 V. Its de Broglie wavelength is, (nearly) : ($m_e = 9 \times 10^{-31}$ kg)

- (1) 12.2×10^{-13} m
- (2) 12.2×10^{-12} m
- (3) 12.2×10^{-14} m
- (4) 12.2 nm

Answer (2)

Sol. For an electron accelerated through a potential V

$$\lambda = \frac{12.27}{\sqrt{V}} \text{ \AA} = \frac{12.27 \times 10^{-10}}{\sqrt{10000}} = 12.27 \times 10^{-12} \text{ m}$$

84. When an object is shot from the bottom of a long smooth inclined plane kept at an angle 60° with horizontal, it can travel a distance x_1 along the plane. But when the inclination is decreased to 30° and the same object is shot with the same velocity, it can travel x_2 distance. Then $x_1 : x_2$ will be:

- (1) $1:\sqrt{2}$
- (2) $\sqrt{2}:1$
- (3) $1:\sqrt{3}$
- (4) $1:2\sqrt{3}$

Answer (3)

Sol.

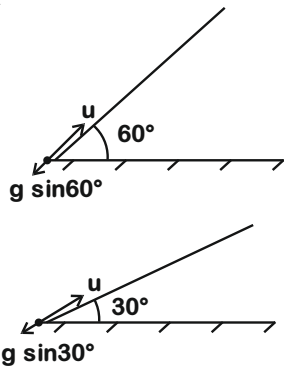

$$\text{(Stopping distance)} \quad x_1 = \frac{u^2}{2g \sin 60^\circ}$$

$$\text{(Stopping distance)} \quad x_2 = \frac{u^2}{2g \sin 30^\circ}$$

$$\Rightarrow \frac{x_1}{x_2} = \frac{\sin 30^\circ}{\sin 60^\circ} = \frac{1 \times 2}{2 \times \sqrt{3}} = 1:\sqrt{3}$$

85. A small hole of area of cross-section 2 mm^2 is present near the bottom of a fully filled open tank of height 2 m. Taking $g = 10 \text{ m/s}^2$, the rate of flow of water through the open hole would be nearly

- (1) $12.6 \times 10^{-6} \text{ m}^3/\text{s}$
- (2) $8.9 \times 10^{-6} \text{ m}^3/\text{s}$
- (3) $2.23 \times 10^{-6} \text{ m}^3/\text{s}$
- (4) $6.4 \times 10^{-6} \text{ m}^3/\text{s}$

Answer (1)

Sol.

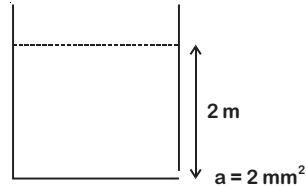

Rate of flow liquid

$$\begin{aligned} Q &= au = a\sqrt{2gh} \\ &= 2 \times 10^{-6} \text{ m}^2 \times \sqrt{2 \times 10 \times 2} \text{ m/s} \\ &= 2 \times 2 \times 3.14 \times 10^{-6} \text{ m}^3/\text{s} \\ &= 12.56 \times 10^{-6} \text{ m}^3/\text{s} \\ &= 12.6 \times 10^{-6} \text{ m}^3/\text{s} \end{aligned}$$

86. Two point charges A and B, having charges $+Q$ and $-Q$ respectively, are placed at certain distance apart and force acting between them is F. If 25% charge of A is transferred to B, then force between the charges becomes :

- (1) F
- (2) $\frac{9F}{16}$
- (3) $\frac{16F}{9}$
- (4) $\frac{4F}{3}$

Answer (2)

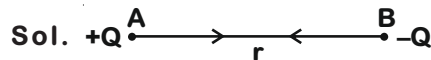

$$F = \frac{kQ^2}{r^2}$$

If 25% of charge of A transferred to B then

$$q_A = Q - \frac{Q}{4} = \frac{3Q}{4} \quad \text{and} \quad q_B = -Q + \frac{Q}{4} = \frac{-3Q}{4}$$

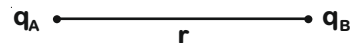

$$F_1 = \frac{kq_A q_B}{r^2}$$

$$F_1 = \frac{k \left(\frac{3Q}{4} \right)^2}{r^2}$$

$$F_1 = \frac{9}{16} \frac{kQ^2}{r^2}$$

$$F_1 = \frac{9F}{16}$$

87. Ionized hydrogen atoms and α -particles with same momenta enters perpendicular to a constant magnetic field, B . The ratio of their radii of their paths $r_H : r_\alpha$ will be :

- (1) 2 : 1 (2) 1 : 2
 (3) 4 : 1 (4) 1 : 4

Answer (1)

Sol. $r_H = \frac{p}{eB}$

$r_\alpha = \frac{p}{2eB}$

$\frac{r_H}{r_\alpha} = \frac{\frac{p}{eB}}{\frac{p}{2eB}}$

$\frac{r_H}{r_\alpha} = \frac{2}{1}$

88. A particle moving with velocity \vec{v} is acted by three forces shown by the vector triangle PQR. The velocity of the particle will :

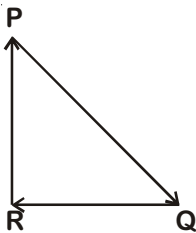

- (1) Increase
 (2) Decrease
 (3) Remain constant
 (4) Change according to the smallest force

\vec{QR}

Answer (3)

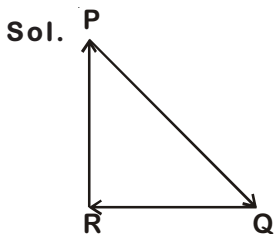

As forces are forming closed loop in same order

So, $\vec{F}_{net} = 0$

$\Rightarrow m \frac{d\vec{v}}{dt} = 0$

$\Rightarrow \vec{v} = \text{constant}$

89. The work done to raise a mass m from the surface of the earth to a height h , which is equal to the radius of the earth, is:

- (1) mgR (2) $2mgR$
 (3) $\frac{1}{2}mgR$ (4) $\frac{3}{2}mgR$

Answer (3)

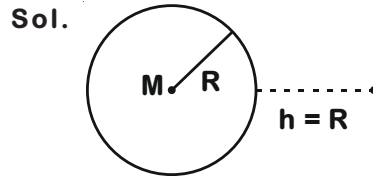

Initial potential energy at earth's surface is

$U_i = \frac{-GMm}{R}$

Final potential energy at height $h = R$

$U_f = \frac{-GMm}{2R}$

As work done = Change in PE

$\therefore W = U_f - U_i$

$= \frac{GMm}{2R} = \frac{gR^2m}{2R} = \frac{mgR}{2}$ ($\because GM = gR^2$)

90. In a double slit experiment, when light of wavelength 400 nm was used, the angular width of the first minima formed on a screen placed 1 m away, was found to be 0.2° . What will be the angular width of the first minima, if the entire experimental apparatus is immersed in water? ($\mu_{\text{water}} = 4/3$)

- (1) 0.266°
 (2) 0.15°
 (3) 0.05°
 (4) 0.1°

Answer (2)

Sol. In air angular fringe width $\theta_0 = \frac{\beta}{D}$

Angular fringe width in water

$\theta_w = \frac{\beta}{\mu D} = \frac{\theta_0}{\mu}$

$= \frac{0.2^\circ}{\left(\frac{4}{3}\right)} = 0.15^\circ$

99. Which of these following methods is the most suitable for disposal of nuclear waste?
- (1) Shoot the waste into space
 - (2) Bury the waste under Antarctic ice-cover
 - (3) Dump the waste within rocks under deep ocean
 - (4) Bury the waste within rocks deep below the Earth's surface

Answer (4)

Sol. Storage of nuclear waste should be done in suitably shielded containers and buried within rocks deep below the earth's surface (500 m deep)

100. Match the following organisms with the products they produce
- | | |
|-------------------------------------|-------------------|
| (a) <i>Lactobacillus</i> | (i) Cheese |
| (b) <i>Saccharomyces cerevisiae</i> | (ii) Curd |
| (c) <i>Aspergillus niger</i> | (iii) Citric Acid |
| (d) <i>Acetobacter aceti</i> | (iv) Bread |
| | (v) Acetic Acid |

Select the correct option.

- | (a) | (b) | (c) | (d) |
|-----------|------|-------|-------|
| (1) (ii) | (iv) | (v) | (iii) |
| (2) (ii) | (iv) | (iii) | (v) |
| (3) (iii) | (iv) | (v) | (i) |
| (4) (ii) | (i) | (iii) | (v) |

Answer (2)

Sol. Microbes are used in production of several household and industrial products –
Lactobacillus – Production of curd
Saccharomyces cerevisiae – Bread making
Aspergillus niger – Citric acid production
Acetobacter aceti – Acetic acid

101. What map unit (Centimorgan) is adopted in the construction of genetic maps?
- (1) A unit of distance between two expressed genes representing 10% cross over.
 - (2) A unit of distance between two expressed genes representing 100% cross over.
 - (3) A unit of distance between genes on chromosomes, representing 1% cross over.
 - (4) A unit of distance between genes on chromosomes, representing 50% cross over.

Answer (3)

Sol. 1 map unit represent 1 % cross over.

Map unit is used to measure genetic distance.

This genetic distance is based on average number of cross over frequency.

102. Select the hormone-releasing Intra-Uterine Devices.
- (1) Vaults, LNG-20
 - (2) Multiload 375, Progestasert
 - (3) Progestasert, LNG-20
 - (4) Lippes Loop, Multiload 375

Answer (3)

Sol. Progestasert and LNG-20 are hormone releasing IUDs which make the uterus unsuitable for implantation and the cervix hostile to sperms.

103. Which of the following can be used as a biocontrol agent in the treatment of plant disease?
- | | |
|------------------------|--------------------------|
| (1) <i>Trichoderma</i> | (2) <i>Chlorella</i> |
| (3) <i>Anabaena</i> | (4) <i>Lactobacillus</i> |

Answer (1)

Sol. Fungus *Trichoderma* is a biological control agent being developed for use in the treatment of plant diseases.

104. Expressed Sequence Tags (ESTs) refers to :
- (1) Genes expressed as RNA
 - (2) Polypeptide expression
 - (3) DNA polymorphism
 - (4) Novel DNA sequences

Answer (1)

Sol. Expressed Sequence Tags (ESTs) are DNA sequences (genes) that are expressed as mRNA for protein synthesis. These are used in human Genome Project.

105. Colostrum the yellowish fluid, secreted by mother during the initial days of lactation is very essential to impart immunity to the new born infants because it contains
- (1) Natural killer cells
 - (2) Monocytes
 - (3) Macrophages
 - (4) Immunoglobulin A

Answer (4)

Sol. Colostrum, the yellowish fluid secreted by the mother during initial days of lactation is very essential to impart immunity to the new born infant because it contains Immunoglobulin A. It will impart naturally acquired passive immunity to the newborn

106. Select the incorrect statement.

- (1) Inbreeding increases homozygosity
- (2) Inbreeding is essential to evolve purelines in any animal.
- (3) Inbreeding selects harmful recessive genes that reduce fertility and productivity
- (4) Inbreeding helps in accumulation of superior genes and elimination of undesirable genes

Answer (3)

Sol. Inbreeding exposes harmful recessive genes that are eliminated by selection. It also helps in accumulation of superior genes and elimination of less desirable genes. Therefore this is selection at each step, increase the productivity of inbred population. Close and continued inbreeding usually reduces fertility and even productivity.

107. Select the correct sequence for transport of sperm cells in male reproductive system.

- (1) Testis → Epididymis → Vasa efferentia → Rete testis → Inguinal canal → Urethra
- (2) Seminiferous tubules → Rete testis → Vasa efferentia → Epididymis → Vas deferens → Ejaculatory duct → Urethra → Urethral meatus
- (3) Seminiferous tubules → Vasa efferentia → Epididymis → Inguinal canal → Urethra
- (4) Testis → Epididymis → Vasa efferentia → Vas deferens → Ejaculatory duct → Inguinal canal → Urethra → Urethral meatus

Answer (2)

Sol. The correct sequence for transport of sperm cells in male reproductive system is Seminiferous tubules → Rete testis → Vasa efferentia → Epididymis → Vas deferens → Ejaculatory duct → Urethra → Urethral meatus

108. A gene locus has two alleles A, a. If the frequency of dominant allele A is 0.4, then what will be the frequency of homozygous dominant, heterozygous and homozygous recessive individuals in the population?

- (1) 0.36(AA); 0.48(Aa); 0.16(aa)
- (2) 0.16(AA); 0.24(Aa); 0.36(aa)
- (3) 0.16(AA); 0.48(Aa); 0.36(aa)
- (4) 0.16(AA); 0.36(Aa); 0.48(aa)

Answer (3)

Sol. Frequency of dominant allele (say p) = 0.4

Frequency of recessive allele (say q)

$$= 1 - 0.4 = 0.6$$

∴ Frequency of homozygous dominant individuals (AA)

$$= p^2 = (0.4)^2 = 0.16$$

Frequency of heterozygous individuals (Aa)

$$= 2pq = 2(0.4)(0.6) = 0.48$$

Frequency of homozygous recessive individuals (aa)

$$= q^2 = (0.6)^2 = 0.36$$

109. Match the following organisms with their respective characteristics :

- | | |
|--------------------------|-------------------------|
| (a) <i>Pila</i> | (i) Flame cells |
| (b) <i>Bombyx</i> | (ii) Comb plates |
| (c) <i>Pleurobrachia</i> | (iii) Radula |
| (d) <i>Taenia</i> | (iv) Malpighian tubules |

Select the correct option from the following :

- | | (a) | (b) | (c) | (d) |
|-----|-------|------|-------|------|
| (1) | (iii) | (ii) | (i) | (iv) |
| (2) | (iii) | (iv) | (ii) | (i) |
| (3) | (ii) | (iv) | (iii) | (i) |
| (4) | (iii) | (ii) | (iv) | (i) |

Answer (2)

Sol. (a) *Pila* is a Mollusc. The mouth contains a file - like rasping organ for feeding called radula.

(b) *Bombyx* is an Arthropod. In *Bombyx* excretion takes place through malpighian tubules.

(c) *Pleurobrachia* is Ctenophore. The body bears eight external rows of ciliated comb plates, which help in locomotion.

(d) *Taenia* is a platyhelminth specialised cells called flame cells helps in osmoregulation and excretion

110. The shorter and longer arms of a submetacentric chromosome are referred to as

- (1) s-arm and l-arm respectively
- (2) p-arm and q-arm respectively
- (3) q-arm and p-arm respectively
- (4) m-arm and n-arm respectively

Answer (2)

Sol. • Sub metacentric chromosome is Heterobrachial.

- Short arm designated as 'p' arm (p = petite *i.e.* short)
- Long arm designated as 'q' arm

111. What is the site of perception of photoperiod necessary for induction of flowering in plants?

- (1) Lateral buds (2) Pulvinus
- (3) Shoot apex (4) Leaves

Answer (4)

Sol. During flowering, photoperiodic stimulus is perceived by leaves of plants.

112. Which part of the brain is responsible for thermoregulation?

- (1) Cerebrum
- (2) Hypothalamus
- (3) Corpus callosum
- (4) Medulla oblongata

Answer (2)

Sol. Hypothalamus in the thermoregulatory centre of our brain. It is responsible for maintaining constant body temperature.

113. Which of the following pair of organelles does not contain DNA?

- (1) Mitochondria and Lysosomes
- (2) Chloroplast and Vacuoles
- (3) Lysosomes and Vacuoles
- (4) Nuclear envelope and Mitochondria

Answer (3)

Sol. Lysosomes and Vacuoles do not have DNA.

114. What is the genetic disorder in which an individual has an overall masculine development gynaecomastia, and is sterile ?

- (1) Turner's syndrome
- (2) Klinefelter's syndrome
- (3) Edward syndrome
- (4) Down's syndrome

Answer (2)

Sol. Individuals with Klinefelter's syndrome have trisomy of sex chromosome as 44 + XXY (47). They show overall masculine development, gynaecomastia and are sterile.

115. Xylem translocates.

- (1) Water only
- (2) Water and mineral salts only
- (3) Water, mineral salts and some organic nitrogen only
- (4) Water, mineral salts, some organic nitrogen and hormones

Answer (4)

Sol. Xylem is associated with translocation of mainly water, mineral salts, some organic nitrogen and hormones.

116. Which of the following pairs of gases is mainly responsible for green house effect?

- (1) Ozone and Ammonia
- (2) Oxygen and Nitrogen
- (3) Nitrogen and Sulphur dioxide
- (4) Carbon dioxide and Methane

Answer (4)

Sol. Relative contribution of various greenhouse gases to total global warming is

- $\text{CO}_2 = 60\%$
- $\text{CH}_4 = 20\%$
- $\text{CFC} = 14\%$
- $\text{N}_2\text{O} = 6\%$

⇒ Therefore CO_2 and CH_4 are the major greenhouse gases

117. Which of the following protocols did aim for reducing emission of chlorofluorocarbons into the atmosphere?

- (1) Montreal Protocol
- (2) Kyoto Protocol
- (3) Gothenburg Protocol
- (4) Geneva Protocol

Answer (1)

Sol. To control the deleterious effect of the stratospheric ozone depletion an international treaty was signed at Montreal, Canada in 1987. It is popularly known as Montreal protocol.

118. In some plants, the female gamete develops into embryo without fertilization. This phenomenon is known as

- (1) Autogamy (2) Parthenocarpy
- (3) Syngamy (4) Parthenogenesis

Answer (4)

Sol. The phenomenon in which female gamete develops into embryo without getting fused with male gamete (fertilisation) is called parthenogenesis.

119. Which of the following sexually transmitted diseases is not completely curable?

- (1) Gonorrhoea (2) Genital warts
- (3) Genital herpes (4) Chlamydia

Answer (3)

Sol. Genital herpes is caused by type-II-herpes simplex virus. At present there is no cure for type-II-herpes simplex virus and therefore the disease caused, genital herpes. Other non-curable STIs are hepatitis-B and HIV.

120. Which of the following immune responses is responsible for rejection of kidney graft?

- (1) Auto-immune response
- (2) Humoral immune response
- (3) Inflammatory immune response
- (4) Cell-mediated immune response

Answer (4)

Sol. The body is able to differentiate self and nonself and the cell-mediated response is responsible for graft rejection.

121. Which of the following factors is responsible for the formation of concentrated urine?

- (1) Low levels of antidiuretic hormone
- (2) Maintaining hyperosmolarity towards inner medullary interstitium in the kidneys.
- (3) Secretion of erythropoietin by Juxtaglomerular complex
- (4) Hydrostatic pressure during glomerular filtration

Answer (2)

Sol. The proximity between loop of henle and vasa recta as well as counter current in them help in maintaining an increasing osmolality towards the inner medullary interstitium. This mechanism help to maintain a concentration gradient in medullary interstitium so human urine is nearly four times concentrated than initial filtrate formed.

122. Which of the following features of genetic code does allow bacteria to produce human insulin by recombinant DNA technology?

- (1) Genetic code is not ambiguous
- (2) Genetic code is redundant
- (3) Genetic code is nearly universal
- (4) Genetic code is specific

Answer (3)

Sol. In recombinant DNA technology bacteria is able to produce human insulin because genetic code is nearly universal.

123. Which of the following statements is not correct?

- (1) Lysosomes have numerous hydrolytic enzymes
- (2) The hydrolytic enzymes of lysosomes are active under acidic pH
- (3) Lysosomes are membrane bound structures
- (4) Lysosomes are formed by the process of packaging in the endoplasmic reticulum

Answer (4)

Sol. Lysosomes bud off from trans face of Golgi bodies.

Precursor of lysosomal enzymes are synthesised by RER and then send to Golgi bodies for further processing.

124. The concept of “*Omnis cellula-e cellula*” regarding cell division was first proposed by
- (1) Rudolf Virchow
 - (2) Theodor Schwann
 - (3) Schleiden
 - (4) Aristotle

Answer (1)

Sol. Concept of “*Omnis cellula-e cellula*” regarding cell division was proposed by Rudolph Virchow.

125. Use of an artificial kidney during hemodialysis may result in :
- (a) Nitrogenous waste build-up in the body
 - (b) Non-elimination of excess potassium ions
 - (c) Reduced absorption of calcium ions from gastro-intestinal tract
 - (d) Reduced RBC production

Which of the following options is the most appropriate?

- (1) (a) and (b) are correct
- (2) (b) and (c) are correct
- (3) (c) and (d) are correct
- (4) (a) and (d) are correct

Answer (3)

Sol. a and b statements are incorrect because dialysis eliminates urea and potassium from the body whereas, c and d are correct. As phosphate ions are eliminated during dialysis, along with that calcium ions are also eliminated. So, there will be reduced absorption of calcium ions from gastrointestinal tract. RBC production will be reduced, due to reduced erythropoietin hormone.

126. What is the direction of movement of sugars in phloem?
- (1) Non-multidirectional
 - (2) Upward
 - (3) Downward
 - (4) Bi-directional

Answer (4)

Sol. The direction of movement of sugar in phloem is bi-directional as it depends on source-sink relationship which is variable in plants.

127. Which of the following muscular disorders is inherited?

- (1) Tetany
- (2) Muscular dystrophy
- (3) Myasthenia gravis
- (4) Botulism

Answer (2)

Sol. Progressive degeneration of skeletal muscle mostly due to genetic disorder is muscular dystrophy where as tetany is muscular spasm due to low calcium in body fluid. Myasthenia gravis is an auto immune disorder leading to paralysis of skeletal muscles. Botulism is rare and dangerous type of food poisoning caused by bacterium *Clostridium Botulinum*.

128. Consider following features

- (a) Organ system level of organisation
- (b) Bilateral symmetry
- (c) True coelomates with segmentation of body

Select the correct option of animal groups which possess all the above characteristics

- (1) Annelida, Arthropoda and Chordata
- (2) Annelida, Arthropoda and Mollusca
- (3) Arthropoda, Mollusca and Chordata
- (4) Annelida, Mollusca and Chordata

Answer (1)

Sol. True segmentation is present in Annelida, Arthropoda and Chordata. They also have organ system level of organisation, bilateral symmetry and are true coelomates

129. The frequency of recombination between gene pairs on the same chromosome as a measure of the distance between genes was explained by :

- (1) T.H. Morgan
- (2) Gregor J. Mendel
- (3) Alfred Sturtevant
- (4) Sutton Boveri

Answer (3)

Sol. Alfred Sturtevant explained chromosomal mapping on the basis of recombination frequency which is directly proportional to distance between two genes on same chromosome

130. Following statements describe the characteristics of the enzyme Restriction Endonuclease. Identify the incorrect statement.

- (1) The enzyme cuts DNA molecule at identified position within the DNA.
- (2) The enzyme binds DNA at specific sites and cuts only one of the two strands.
- (3) The enzyme cuts the sugar-phosphate backbone at specific sites on each strand.
- (4) The enzyme recognizes a specific palindromic nucleotide sequence in the DNA.

Answer (2)

Sol. Restriction enzymes cut DNA molecules at a particular point by recognising a specific sequence. Each restriction endonuclease functions by inspecting the length of a DNA sequence. Once it finds its specific recognition sequence, it will bind to the DNA and cut each of the two strands of the double helix at specific points in their sugar-phosphate backbone.

131. Which of the following statements is incorrect?

- (1) Morels and truffles are edible delicacies.
- (2) *Claviceps* is a source of many alkaloids and LSD.
- (3) Conidia are produced exogenously and ascospores endogenously.
- (4) Yeasts have filamentous bodies with long thread-like hyphae.

Answer (4)

Sol. Yeast is an unicellular sac fungus. It lacks filamentous structure or hyphae.

132. Placentation in which ovules develop on the inner wall of the ovary or in peripheral part, is

- (1) Basal
- (2) Axile
- (3) Parietal
- (4) Free central

Answer (3)

Sol. In parietal placentation the ovules develop on the inner wall of ovary or in peripheral part. eg. Mustard, *Argemone* etc.

133. Which of the following is the most important cause for animals and plants being driven to extinction?

- (1) Habitat loss and fragmentation
- (2) Drought and floods
- (3) Economic exploitation
- (4) Alien species invasion

Answer (1)

Sol. Habitat loss and fragmentation is the most important cause driving animals and plants to extinction.

eg: Loss of tropical rainforest reducing the forest cover from 14 % to 6 %.

134. Variations caused by mutation, as proposed by Hugo de Vries are

- (1) random and directional
- (2) random and directionless
- (3) small and directional
- (4) small and directionless

Answer (2)

Sol. According to Hugo de Vries, mutations are random and directionless.

Devries believed mutation caused speciation and hence called saltation (single step large mutation).

135. Respiratory Quotient (RQ) value of tripalmitin is

- (1) 0.9
- (2) 0.7
- (3) 0.07
- (4) 0.09

Answer (2)

Sol. Respiratory Quotient = $\frac{\text{Amount of CO}_2 \text{ released}}{\text{Amount of O}_2 \text{ consumed}}$ (RQ)

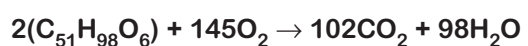

Tripalmitin + Energy

$$\text{RQ} = \frac{102 \text{ CO}_2}{145 \text{ O}_2} = 0.7$$

136. In *Antirrhinum* (Snapdragon), a red flower was crossed with a white flower and in F_1 generation pink flowers were obtained. When pink flowers were selfed, the F_2 generation showed white, red and pink flowers. Choose the incorrect statement from the following :

- (1) This experiment does not follow the Principle of Dominance.
- (2) Pink colour in F_1 is due to incomplete dominance.
- (3) Ratio of F_2 is $\frac{1}{4}$ (Red) : $\frac{2}{4}$ (Pink) : $\frac{1}{4}$ (White)
- (4) Law of Segregation does not apply in this experiment

Answer (4)

Sol. Genes for flower colour in snapdragon shows incomplete dominance which is an exception of Mendel's first principle *i.e.* Law of dominance.

Whereas Law of segregation is universally applicable.

137. Select the incorrect statement.

- (1) Male fruit fly is heterogametic
- (2) In male grasshoppers 50% of sperms have no sex-chromosome
- (3) In domesticated fowls, sex of progeny depends on the type of sperm rather than egg
- (4) Human males have one of their sex-chromosome much shorter than the other

Answer (3)

Sol. In birds female heterogamety is found thus sex of progeny depends on the types of egg rather than the type of sperm.

eg.

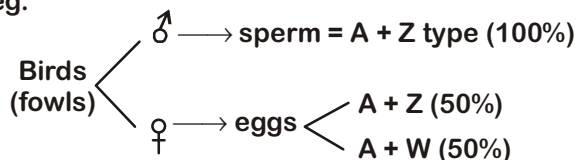

138. The correct sequence of phases of cell cycle is

- (1) $M \rightarrow G_1 \rightarrow G_2 \rightarrow S$
- (2) $G_1 \rightarrow G_2 \rightarrow S \rightarrow M$
- (3) $S \rightarrow G_1 \rightarrow G_2 \rightarrow M$
- (4) $G_1 \rightarrow S \rightarrow G_2 \rightarrow M$

Answer (4)

Sol. The correct sequence of phases of cell cycle is $G_1 \rightarrow S \rightarrow G_2 \rightarrow M$

139. *Thiobacillus* is a group of bacteria helpful in carrying out

- (1) Nitrogen fixation
- (2) Chemoautotrophic fixation
- (3) Nitrification
- (4) Denitrification

Answer (4)

Sol. *Thiobacillus denitrificans* cause denitrification *i.e.*, conversion of oxides of nitrogen to free N_2 .

140. Polyblend, a fine powder of recycled modified plastic, has proved to be a good material for

- (1) Making plastic sacks
- (2) Use as a fertilizer
- (3) Construction of roads
- (4) Making tubes and pipes

Answer (3)

Sol. Polyblend is a fine powder of recycled modified plastic waste. The mixture is mixed with bitumen that is used to lay roads

141. From evolutionary point of view, retention of the female gametophyte with developing young embryo on the parent sporophyte for some time, is first observed in

- (1) Liverworts
- (2) Mosses
- (3) Pteridophytes
- (4) Gymnosperms

Answer (3)

Sol. In Pteridophyte, megaspore is retained for some times in female gametophyte, however the permanent retention is required for seed formation in Gymnosperms.

That's why Pteridophytes exhibit precursor to seed habit only.

142. Select the correct option.

- (1) 8th, 9th and 10th pairs of ribs articulate directly with the sternum.
- (2) 11th and 12th pairs of ribs are connected to the sternum with the help of hyaline cartilage.
- (3) Each rib is a flat thin bone and all the ribs are connected dorsally to the thoracic vertebrae and ventrally to the sternum.
- (4) There are seven pairs of vertebrosteral, three pairs of vertebrochondral and two pairs of vertebral ribs.

Answer (4)

- Sol.** • Vertebrosteral ribs are true ribs, dorsally they are attached to the thoracic vertebrae and ventrally connected to the sternum with the help of hyaline cartilage. First seven pairs of ribs are called true ribs.
- 8th, 9th and 10th pairs of ribs do not articulate directly with the sternum but join the seventh ribs with the help of hyaline cartilage. These are vertebrochondral or false ribs.
 - Last 2 pairs (11 & 12) of ribs are not connected ventrally and are therefore, called floating ribs.
 - Only first seven pairs of ribs are ventrally connected to the sternum.

143. Concanavalin A is

- (1) an alkaloid
- (2) an essential oil
- (3) a lectin
- (4) a pigment

Answer (3)

Sol. Concanavalin A is a secondary metabolite *e.g* is lectin, it has the property to agglutinates RBCs.

144. Extrusion of second polar body from egg nucleus occurs :

- (1) after entry of sperm but before fertilization
- (2) after fertilization
- (3) before entry of sperm into ovum
- (4) simultaneously with first cleavage

Answer (1)

Sol. Extrusion of second polar body from egg nucleus occurs after entry of sperm but before fertilization.

The entry of sperm into the ovum induces completion of the meiotic division of the secondary oocyte.

Entry of sperm causes breakdown of metaphase promoting factor (MPF) and turns on anaphase promoting complex (APC).

145. *Pinus* seed cannot germinate and established without fungal association. This is because :

- (1) its embryo is immature.
- (2) it has obligate association with mycorrhizae.
- (3) it has very hard seed coat.
- (4) its seeds contain inhibitors that prevent germination.

Answer (2)

Sol. Fungus associated with roots of *Pinus* increases minerals & water absorption for the plant by increasing surface area and in turn fungus gets food from plant. Therefore, mycorrhizal association is obligatory for *Pinus* seed germination

146. The Earth Summit held in Rio de Janeiro in 1992 was called

- (1) to reduce CO₂ emissions and global warming
- (2) for conservation of biodiversity and sustainable utilization of its benefits
- (3) to assess threat posed to native species by invasive weed species
- (4) for immediate steps to discontinue use of CFCs that were damaging the ozone layer

Answer (2)

Sol. Earth Summit (Rio Summit)-1992, called upon all nations to take appropriate measures for conservation of biodiversity and sustainable utilisation of its benefits

147. DNA precipitation out of a mixture of biomolecules can be achieved by treatment with

- (1) Isopropanol
- (2) Chilled ethanol
- (3) Methanol at room temperature
- (4) Chilled chloroform

Answer (2)

Sol. During the isolation of desired gene, chilled ethanol is used for the precipitation of DNA.

148. Grass leaves curl inwards during very dry weather. Select the most appropriate reason from the following

- (1) Closure of stomata
- (2) Flaccidity of bulliform cells
- (3) Shrinkage of air spaces in spongy mesophyll
- (4) Tyloses in vessels

Answer (2)

Sol. Bulliform cells become flaccid due to water loss. This will make the leaves to curl inward to minimise water loss

149. Match the following structures with their respective location in organs

- | | | |
|--------------------------|-------|-----------------|
| (a) Crypts of Lieberkuhn | (i) | Pancreas |
| (b) Glisson's Capsule | (ii) | Duodenum |
| (c) Islets of Langerhans | (iii) | Small intestine |
| (d) Brunner's Glands | (iv) | Liver |

Select the correct option from the following

- | | (a) | (b) | (c) | (d) |
|-----|-------|------|------|-------|
| (1) | (iii) | (i) | (ii) | (iv) |
| (2) | (ii) | (iv) | (i) | (iii) |
| (3) | (iii) | (iv) | (i) | (ii) |
| (4) | (iii) | (ii) | (i) | (iv) |

Answer (3)

Sol. Crypts of Lieberkuhn are present in small intestine. Glisson's capsule is present in liver. Islets of langerhans constitutes the endocrine portion of pancreas. Brunner's glands are found in submucosa of duodenum.

150. Match the following hormones with the respective disease

- | | |
|--------------------|-------------------------|
| (a) Insulin | (i) Addison's disease |
| (b) Thyroxin | (ii) Diabetes insipidus |
| (c) Corticoids | (iii) Acromegaly |
| (d) Growth Hormone | (iv) Goitre |
| | (v) Diabetes mellitus |

Select the correct option.

- | | (a) | (b) | (c) | (d) |
|-----|------|------|-------|-------|
| (1) | (v) | (i) | (ii) | (iii) |
| (2) | (ii) | (iv) | (iii) | (i) |
| (3) | (v) | (iv) | (i) | (iii) |
| (4) | (ii) | (iv) | (i) | (iii) |

Answer (3)

Sol. • Insulin deficiency leads to diabetes mellitus

- Hypersecretion or hyposecretion of thyroxine can be associated with enlargement of thyroid gland called goitre
- Deficiency of corticoids (Glucocorticoid + mineralocorticoid) leads to Addison's disease
- Growth hormone hypersecretion in adults leads to Acromegaly

151. Which of the following contraceptive methods do involve a role of hormone?

- (1) Lactational amenorrhea, Pills Emergency contraceptives.
- (2) Barrier method, Lactational amenorrhea, Pills.
- (3) CuT, Pills, Emergency contraceptives.
- (4) Pills, Emergency contraceptives, Barrier methods.

Answer (1)

Sol. → In lactational amenorrhoea, due to high prolactin level, gonadotropin level decreases.

→ Oral pills are either progestogens or progestogen-estrogen combinations used by the females.

→ Emergency contraceptives includes the administration of progestogens or progestogen-estrogen combination or IUDs within 72 hour of coitus.

So, lactational amenorrhoea, oral pills and emergency contraceptives involve a role of hormone.

152. Drug called 'Heroin' is synthesized by

- (1) methylation of morphine
- (2) acetylation of morphine
- (3) glycosylation of morphine
- (4) nitration of morphine

Answer (2)

Sol. Heroin, commonly called smack and is chemically diacetylmorphine which is synthesized by acetylation of morphine.

153. In a species, the weight of newborn ranges from 2 to 5 kg. 97% of the newborn with an average weight between 3 to 3.3 kg survive whereas 99% of the infants born with weight from 2 to 2.5 kg or 4.5 to 5 kg die. Which type of selection process is taking place?

- (1) Directional Selection
- (2) Stabilizing Selection
- (3) Disruptive Selection
- (4) Cyclical Selection

Answer (2)

Sol. The given data shows stabilising selection as most of the newborn having average weight between 3 to 3.3 kg survive and babies with less and more weight have low survival rate.

154. Conversion of glucose to glucose-6-phosphate, the first irreversible reaction of glycolysis, is catalyzed by

- (1) Aldolase
- (2) Hexokinase
- (3) Enolase
- (4) Phosphofructokinase

Answer (2)

Sol. Hexokinase catalyse the conversion of Glucose to Glucose-6 phosphate. It is the first step of activation phase of glycolysis.

155. Which of the following statements is correct?

- (1) Cornea is an external, transparent and protective proteinaceous covering of the eye-ball.
- (2) Cornea consists of dense connective tissue of elastin and can repair itself.
- (3) Cornea is convex, transparent layer which is highly vascularised.
- (4) Cornea consists of dense matrix of collagen and is the most sensitive portion the eye.

Answer (4)

Sol. Cornea consists of dense matrix of collagen and corneal epithelium. It is the most sensitive part of eye.

156. Which of the following ecological pyramids is generally inverted?

- (1) Pyramid of numbers in grassland
- (2) Pyramid of energy
- (3) Pyramid of biomass in a forest
- (4) Pyramid of biomass in a sea

Answer (4)

Sol. In an aquatic ecosystem, the pyramid of biomass is generally inverted.

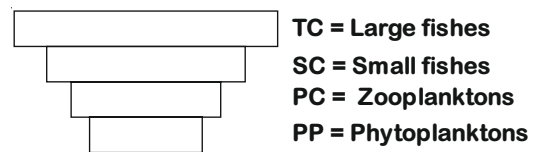

157. Consider the following statement :

- (A) Coenzyme or metal ion that is tightly bound to enzyme protein is called prosthetic group.
- (B) A complete catalytic active enzyme with its bound prosthetic group is called apoenzyme.

Select the correct option.

- (1) Both (A) and (B) are true.
- (2) (A) is true but (B) is false.
- (3) Both (A) and (B) are false.
- (4) (A) is false but (B) is true.

Answer (2)

Sol. Coenzyme or metal ion that is tightly bound to enzyme protein is called prosthetic group. A complete catalytic active enzyme with its bound prosthetic group is called holoenzyme.

158. Due to increasing air-borne allergens and pollutants, many people in urban areas are suffering from respiratory disorder causing wheezing due to

- (1) benign growth on mucous lining of nasal cavity
- (2) inflammation of bronchi and bronchioles
- (3) proliferation of fibrous tissues and damage of the alveolar walls
- (4) reduction in the secretion of surfactants by pneumocytes.

Answer (2)

Sol. Asthma is a difficulty in breathing causing wheezing due to inflammation of bronchi and bronchioles. It can be due to increasing air born allergens and pollutants. Asthma is an allergic condition. Many people in urban areas are suffering from this respiratory disorder.

159. Which one of the following statements regarding post-fertilization development in flowering plants is incorrect?

- (1) Ovary develops into fruit
- (2) Zygote develops into embryo
- (3) Central cell develops into endosperm
- (4) Ovules develop into embryo sac

Answer (4)

Sol. Following are the post-fertilisation changes.

- Ovule → Seed
- Ovary → Fruit
- Zygote → Embryo
- Central cell → Endosperm

160. Phloem in gymnosperms lacks :

- (1) Albuminous cells and sieve cells
- (2) Sieve tubes only
- (3) Companion cells only
- (4) Both sieve tubes and companion cells

Answer (4)

Sol. Phloem in Gymnosperms lacks both sieve tube and companion cells.

161. It takes very long time for pineapple plants to produce flowers. Which combination of hormones can be applied to artificially induce flowering in pineapple plants throughout the year to increase yield?

- (1) Auxin and Ethylene
- (2) Gibberellin and Cytokinin
- (3) Gibberellin and Abscisic acid
- (4) Cytokinin and Abscisic acid

Answer (1)

Sol. Plant hormone auxin induces flowering in pineapple. Ethylene also helps in synchronization of flowering and fruit set up in pineapple.

162. Persistent nucellus in the seed is known as

- (1) Chalaza
- (2) Perisperm
- (3) Hilum
- (4) Tegmen

Answer (2)

Sol. Persistent Nucellus is called Perisperm

e.g.: Black pepper, Beet

163. Cell in G_0 phase :

- (1) exit the cell cycle
- (2) enter the cell cycle
- (3) suspend the cell cycle
- (4) terminate the cell cycle

Answer (1)

Sol. Cells in G_0 phase are said to exit cell cycle. These are at quiescent stage and do not proliferate unless called upon to do so.

164. Match Column - I with Column - II

Column - I	Column - II
(a) Saprophyte	(i) Symbiotic association of fungi with plant roots
(b) Parasite	(ii) Decomposition of dead organic materials
(c) Lichens	(iii) Living on living plants or animals
(d) Mycorrhiza	(iv) Symbiotic association of algae and fungi

Choose the correct answer from the option given below

- | | | | |
|-----------|-------|-------|------|
| (a) | (b) | (c) | (d) |
| (1) (i) | (ii) | (iii) | (iv) |
| (2) (iii) | (ii) | (i) | (iv) |
| (3) (ii) | (i) | (iii) | (iv) |
| (4) (ii) | (iii) | (iv) | (i) |

Answer (4)

- Sol.** Saprophytes - Decomposition of dead organic materials
- Parasites - Grow on/in living plants and animals
- Lichens - Symbiotic association of algae and fungi
- Mycorrhiza - Symbiotic association of fungi with plant roots

165. What would be the heart rate of a person if the cardiac output is 5 L, blood volume in the ventricles at the end of diastole is 100 mL and at the end of ventricular systole is 50 mL?

- (1) 50 beats per minute
- (2) 75 beats per minute
- (3) 100 beats per minute
- (4) 125 beats per minute

Answer (3)

Sol. Cardiac output = stroke volume × Heart rate

- ⇒ Cardiac output = 5L or 5000 ml
- ⇒ Blood volume in ventricles at the end of diastole = 100 ml

⇒ Blood volume in ventricles at the end of systole = 50 ml

Stroke volume = 100 – 50
= 50 ml.

So,

5000 ml = 50 ml × Heart rate

So, Heart rate = 100 beats per minute.

166. What triggers activation of protoxin to active Bt toxin of *Bacillus thuringiensis* in boll worm?

- (1) Body temperature
- (2) Moist surface of midgut
- (3) Alkaline pH of gut
- (4) Acidic pH of stomach

Answer (3)

Sol. *Bacillus thuringiensis* forms protein crystals during a particular phase of their growth. These crystals contain a toxic insecticidal protein. These protein exist as inactive protoxins but once an insect ingest the inactive toxin, it is converted into an active form of toxin due to alkaline pH of the gut which solubilize the crystals. The activated toxin binds to the surface of midgut epithelial cells and create pores that cause cell swelling and lysis and eventually cause death of insect.

167. The ciliated epithelial cells are required to move particles or mucus in a specific direction. In humans, these cells are mainly present in

- (1) Bile duct and Bronchioles
- (2) Fallopian tubes and Pancreatic duct
- (3) Eustachian tube and Salivary duct
- (4) Bronchioles and Fallopian tubes

Answer (4)

Sol. Bronchioles and Fallopian tubes are lined with ciliated epithelium to move particles or mucus in a specific direction.

168. Which of the statements given below is not true about formation of Annual Rings in trees?

- (1) Annual ring is a combination of spring wood and autumn wood produced in a year
- (2) Differential activity of cambium causes light and dark bands of tissue early and late wood respectively.
- (3) Activity of cambium depends upon variation in climate.
- (4) Annual rings are not prominent in trees of temperate region.

Answer (4)

Sol. Growth rings are formed by the seasonal activity of cambium. In plants of temperate regions, cambium is more active in spring and less active in autumn seasons. In temperate regions climatic conditions are not uniform throughout the year. However in tropics climatic conditions are uniform throughout the year.

169. What is the fate of the male gametes discharged in the synergid?

- (1) One fuses with egg other(s) degenerate (s) in the synergid.
- (2) All fuse with the egg.
- (3) One fuses with the egg, other(s) fuse(s) with synergid nucleus.
- (4) One fuses with the egg and other fuses with central cell nuclei.

Answer (4)

Sol. In flowering plants, out of the two male gametes discharged in synergids, one fuses with the egg and other fuses with the secondary or definitive nucleus present in central cell.

Egg (n) + 1st male gamete (n) → Zygote (2n)

Secondary nucleus + 2nd male gamete (n) →
(2n)
(central cell nuclei)

PEN (3n)

170. Match the following genes of the Lac operon with their respective products :

- | | |
|------------|---------------------|
| (a) i gene | (i) β-galactosidase |
| (b) z gene | (ii) Permease |
| (c) a gene | (iii) Repressor |
| (d) y gene | (iv) Transacetylase |

Select the correct option.

- | | | | |
|-----------|-------|------|------|
| (a) | (b) | (c) | (d) |
| (1) (i) | (iii) | (ii) | (iv) |
| (2) (iii) | (i) | (ii) | (iv) |
| (3) (iii) | (i) | (iv) | (ii) |
| (4) (iii) | (iv) | (i) | (ii) |

Answer (3)

Sol. In lac operon

i gene — Repressor

z gene — β-galactosidase

y gene — Permease

a gene — Transacetylase

171. Select the correct sequence of organs in the alimentary canal of cockroach starting from mouth

- (1) Pharynx → Oesophagus → Crop → Gizzard → Ileum → Colon → Rectum
- (2) Pharynx → Oesophagus → Gizzard → Crop → Ileum → Colon → Rectum
- (3) Pharynx → Oesophagus → Gizzard → Ileum → Crop → Colon → Rectum
- (4) Pharynx → Oesophagus → Ileum → Crop → Gizzard → Colon → Rectum

Answer (1)

Sol. The correct sequence of organs in the alimentary canal of cockroach starting from mouth is :

Pharynx → Oesophagus → Crop → Gizzard → Ileum → Colon → Rectum

172. Match the hominids with their correct brain size :

- | | |
|----------------------------------|------------------|
| (a) <i>Homo habilis</i> | (i) 900 cc |
| (b) <i>Homo neanderthalensis</i> | (ii) 1350 cc |
| (c) <i>Homo erectus</i> | (iii) 650-800 cc |
| (d) <i>Homo sapiens</i> | (iv) 1400 cc |

Select the correct option.

- | | | | |
|-----------|-------|------|------|
| (a) | (b) | (c) | (d) |
| (1) (iii) | (i) | (iv) | (ii) |
| (2) (iii) | (ii) | (i) | (iv) |
| (3) (iii) | (iv) | (i) | (ii) |
| (4) (iv) | (iii) | (i) | (ii) |

Answer (3)

Sol. The correct match of hominids and their brain sizes are :

- | | | |
|------------------------------|---|------------|
| <i>Homo habilis</i> | — | 650-800 cc |
| <i>Homo neanderthalensis</i> | — | 1400 cc |
| <i>Homo erectus</i> | — | 900 cc |
| <i>Homo sapiens</i> | — | 1350 cc |

173. Identify the correct pair representing the causative agent of typhoid fever and the confirmatory test for typhoid.

- (1) *Plasmodium vivax* / UTI test
- (2) *Streptococcus pneumoniae* / Widal test
- (3) *Salmonella typhi* / Anthrone test
- (4) *Salmonella typhi* / Widal test

Answer (4)

Sol. *Salmonella typhi* is the causative agent. Confirmatory test = Widal test, it's based on antigen antibody reaction.

174. How does steroid hormone influence the cellular activities?

- (1) Changing the permeability of the cell membrane
- (2) Binding to DNA and forming a gene-hormone complex
- (3) Activating cyclic AMP located on the cell membrane
- (4) Using aquaporin channels as second messenger

Answer (2)

Sol. Steroid hormones directly enter into the cell and bind with intracellular receptors in nucleus to form hormone receptor complex. Hormone receptor complex interacts with the genome

175. Tidal Volume and Expiratory Reserve Volume of an athlete is 500 mL and 1000 mL, respectively. What will be his Expiratory Capacity if the Residual Volume is 1200 mL?

- (1) 1500 mL
- (2) 1700 mL
- (3) 2200 mL
- (4) 2700 mL

Answer (1)

Sol. Tidal Volume = 500 ml

Expiratory Reserve Volume = 1000 ml

Expiratory Capacity = TV + ERV

$$= 500 + 1000$$

$$= 1500 \text{ ml}$$

176. Which of the following is a commercial blood cholesterol lowering agent?

- (1) Cyclosporin A
- (2) Statin
- (3) Streptokinase
- (4) Lipases

Answer (2)

Sol. • Statin is obtained from a yeast (Fungi) called *Monascus purpureus*

- It acts by competitively inhibiting the enzyme responsible for synthesis of cholesterol.

177. Which of the following statements regarding mitochondria is incorrect?

- (1) Outer membrane is permeable to monomers of carbohydrates, fats and proteins.
- (2) Enzymes of electron transport are embedded in outer membrane.
- (3) Inner membrane is convoluted with infoldings.
- (4) Mitochondrial matrix contains single circular DNA molecule and ribosomes.

Answer (2)

Sol. In mitochondria, enzymes for electron transport are present in the inner membrane.

178. Match the Column-I with Column-II

Column-I	Column-II
(a) P - wave	(i) Depolarisation of ventricles
(b) QRS complex	(ii) Repolarisation of ventricles
(c) T - wave	(iii) Coronary ischemia
(d) Reduction in the size of T-wave	(iv) Depolarisation of atria
	(v) Repolarisation of atria

Select the correct option.

	(a)	(b)	(c)	(d)
(1)	(iv)	(i)	(ii)	(iii)
(2)	(iv)	(i)	(ii)	(v)
(3)	(ii)	(i)	(v)	(iii)
(4)	(ii)	(iii)	(v)	(iv)

Answer (1)

Sol. In ECG P-wave represents depolarisation of atria. QRS complex represents depolarisation of ventricles. T-wave represents repolarisation of ventricle *i.e.* return from excited to normal state. Reduction in the size of T-wave *i.e.* if the T-wave represents insufficient supply of oxygen *i.e.* coronary ischaemia.

179. Select the correct group of biocontrol agents.

- (1) *Bacillus thuringiensis*, Tobacco mosaic virus, Aphids
- (2) *Trichoderma*, *Baculovirus*, *Bacillus thuringiensis*
- (3) *Oscillatoria*, *Rhizobium*, *Trichoderma*
- (4) *Nostoc*, *Azospirillum*, *Nucleopolyhedrovirus*

Answer (2)

Sol. Fungus *Trichoderma*, Baculoviruses (NPV) and *Bacillus thuringiensis* are used as biocontrol agents.

Rhizobium, *Nostoc*, *Azospirillum* and *Oscillatoria* are used as biofertilisers, whereas TMV is a pathogen and aphids are pests that harm crop plants.

180. Select the correctly written scientific name of Mango which was first described by Carolus Linnaeus

- (1) *Mangifera indica* Car. Linn.
- (2) *Mangifera indica* Linn.
- (3) *Mangifera indica*
- (4) *Mangifera Indica*

Answer (2)

Sol. According to rules of binomial nomenclature, correctly written scientific name of mango is *Mangifera indica* Linn.

