

3

CHAPTER

Alphabet Test

- How many meaningful English words can be formed with the letters ONFT using each letter only once in each word? **(SBI Clerk 2010)**
 - None
 - One
 - Two
 - Three
 - More than three
- If each of the vowels in the word HONESTLY is changed to the next letter in the English alphabetical series and each consonant is changed to the previous letter in the English alphabetical series, and then the alphabets so formed are arranged in alphabetical order from left to right, which of the following will be fifth from the left of the new arrangement thus formed? **(SBI Clerk 2010)**
 - S
 - R
 - M
 - F
 - P
- If it is possible to make only one meaningful word with the first, second, fifth and sixth letters of the word PYGMALION, which of the following would be the second letter of that word from the right end? If no such word can be made, give 'X' as your answer and if more than one such word can be formed, give your answer as 'Z'. **(SBI Clerk 2010)**
 - X
 - P
 - Y
 - A
 - Z
- How many such pairs of letters are there in the word DUPLICATE each of which has as many letters between them in the word (in both forward and backward directions) as they have between them in the English alphabetical order? **(SBI Clerk 2010)**
 - None
 - One
 - Two
 - Three
 - More than three
- How many meaningful English words can be made with the letters DLEI using each letter only once in each word? **(SBI PO 2010)**
 - None
 - One
 - Two
 - Three
 - More than three
- How many such pairs of letters are there in the word SEARCHES each of which has as many letters between them in the word as in the English alphabet? **(SBI PO 2010)**
 - None
 - One
 - Two
 - Three
 - More than three
- How many such pairs of letters are there in the word TRIBUNAL each of which has as many letters between them in the word as in the English alphabet? **(SBI PO 2010)**
 - None
 - One
 - Two
 - Three
 - More than three
- How many meaningful English words can be formed with the letters LGEU using each letter only once in each word? **(SBI PO 2010)**
 - None
 - One
 - Two
 - Three
 - More than three
- How many meaningful English words can be formed, starting with S, with the second, the fourth, the fifth and the eighth letters of the word PERISHED, using each letter only once in each word? (To be counted from left) **(IBPS Clerk 2011)**
 - None
 - One
 - Two
 - Three
 - More than three
- How many such pairs of letters are there in the word STREAMING each of which has as many letters between them in the word, as in the English alphabet? (In both forward and backward directions) **(IBPS Clerk 2011)**
 - None
 - One
 - Two
 - Three
 - More than three
- How many such pairs of letters are there in the word 'DAREDEVIL' each of which has as many letters between them in the word as in the English alphabet series? (in both forward and backward directions) **(IBPS Clerk 2011)**
 - None
 - One
 - Two
 - Three
 - More than three
- If it is possible to make only one meaningful English word with the second, the third, the seventh and the eighth letters of the word STEADFAST, which of the following will be the second letter of that word? If no such word can be formed, give 'X' as the answer and if more than one such word can be formed, give 'Y' as the answer. **(IBPS Clerk 2011)**
 - E
 - A
 - T
 - X
 - Y
- If it is possible to make only one meaningful English word with the second, fourth, fifth and seventh letters of the word COURTESY, using each letter only once in the word, which of the following will be the third letter of that word? If no such word can be formed, give 'N' as your answer, and if

- more than one such word can be formed, give 'M' as your answer. **(IBPS Clerk 2011)**
- (a) R (b) O
(c) S (d) N
(e) M
14. How many meaningful English words can be made with the third, fifth, seventh and ninth letters of the word DOWNGRADED, using each letter only once in each word? **(IBPS Clerk 2011)**
- (a) None (b) One
(c) Two (d) Three
(e) More than three
15. How many meaningful English words can be made with the second, the fourth, the sixth and the seventh letters of the word STUMBLE using each letter only once in each word? **(IBPS Clerk 2011)**
- (a) None (b) One
(c) Two (d) Three
(e) More than three
16. How many such pairs of letters are there in the word GOVERNMENT each of which has as many letters between them in the word (in both forward and backward directions) as in the English alphabet? **(IBPS Clerk 2011)**
- (a) None (b) One
(c) Two (d) Three
(e) More than three
17. If it is possible to make only one meaningful word with the first, fourth, fifth and tenth letters of the word TELEVISION, which of the following would be the second letter of that word from the right end? If no such word can be made, give 'X' as your answer and if more than one such word can be formed, give your answer as 'Y'. **(SBI Clerk 2011)**
- (a) X (b) L
(c) N (d) E
(e) Y
18. If each of the vowels in the word GOLIATHS is changed to the next letter in the English alphabetical series and each consonant is changed to the previous letter in the English alphabetical series, and then the alphabets so formed are arranged in alphabetical order from left to right, which of the following will be sixth from the left of the new arrangement thus formed? **(SBI Clerk 2011)**
- (a) S (b) P
(c) G (d) J
(e) F
19. How many such pairs of letters are there in the word FORMATION each of which has as many letters between them in the word (in both forward and backward directions) as they have between them in the English alphabetical order? **(SBI Clerk 2011)**
- (a) None (b) One
(c) Two (d) Three
(e) More than three
20. How many meaningful English words can be formed with the letters ADIC using each letter only once in each word? **(SBI Clerk 2011)**
- (a) None (b) One
(c) Two (d) Three
(e) More than three
21. How many meaningful English words can be formed with the letters NCEO using each letter, only one in each word? **(SBI PO 2011)**
- (a) None (b) One
(c) Two (d) Three
(e) More than three
22. The positions of first and the fourth letters of the word LIQUID are interchanged, similarly, the positions of second and fifth letters and third and Sixth letters are interchanged. In the new arrangement thus formed, how many letters are there in the English alphabetical series between the alphabets which are at the extreme ends? **(SBI PO 2011)**
- (a) None (b) Two
(c) Three (d) Four
(e) More than four
23. If each of the alphabets of the word MIRACLE is arranged in alphabetical order from left to right and then each vowel in the new word thus formed is changed to the next letter in the English alphabetical series and each consonant is changed to the previous letter in the English alphabetical series which of the following will be fifth from the right? **(SBI PO 2011)**
- (a) K (b) S
(c) F (d) E
(e) J
24. How many such, pairs of letters are there in the word INCLUDE, each of which has as many letters between them in the word (in both forward and backward directions) as they have between them in the English alphabetical order? **(SBI PO 2011)**
- (a) None (b) One
(c) Two (d) Three
(e) More than three
25. How many such pairs of letters are there in the word 'VIRTUAL', each of which has as many letters between them in the word (in both forward and backward direction) as they have between them in the English alphabetical series? **(IBPS Clerk 2012)**
- (a) None (b) One
(c) Two (d) Three
(e) More than three
26. How many meaningful English words can be formed with the letters 'ILP' using all the letters only once in each word? **(IBPS Clerk 2012)**
- (a) None (b) One
(c) Two (d) Three
(e) More than three
27. If each alternate letter in the word 'FLIPPER' starting with F is changed to the next letter in the English alphabetical series and each of the remaining letters is changed to the previous letters in the English alphabetical series then how many letters will appear more than once in the new arrangement? **(IBPS Clerk 2012)**

- (a) None (b) One
(c) Two (d) Three
(e) Four
28. How many meaningful English words, can be formed with the letters PCYO using all the letters but each letter only once in each word? **(RBI 2012)**
(a) None (b) One
(c) Two (d) Three
(e) More than three
29. The positions of first and the fifth letters of the word SUITABLE are interchanged, similarly, the positions of second and sixth letters, third and seventh letters and fourth and eighth letters are interchanged. In the new arrangement how many letters are there in the English alphabetical series between the alphabet which is third from the left end and the alphabet which is second from the right end? **(RBI 2012)**
(a) None (b) One
(c) Two (d) Four
(e) More than four
30. How many such pairs of letters are there in the word PACKETS, each of which has as many letters between them in the word (in both forward and backward directions) as they have between them in the English alphabetical order? **(RBI 2012)**
(a) One (b) Two
(c) Three (d) Four
(e) More than four
31. How many such pairs of letters are there in the word WONDERS, each of which has as many letters between them in the word (in both forward and backward directions) as they have between them in the English alphabetical series? **(SBI Clerk 2012)**
(a) One (b) Two
(c) Three (d) More than three
(e) None
32. How many such pairs of letters are there in the word 'SUBSTANCE' each of which has as many letters between them in the word (in both forward and backward directions) as in the English alphabet? **(IBPS SO 2012)**
(a) None (b) One
(c) Two (d) Three
(e) More than three
33. How many meaningful English words, **not ending with 'D'** can be made with the third, the fifth, the seventh and the ninth letters of the word 'STEADFAST' using each letter only once in each word? (All letters are counted from left to right) **(IBPS SO 2012)**
(a) None (b) One
(c) Two (d) Three
(e) More than three
34. If it is possible to make only one meaningful word with the second, the fifth, the seventh and the tenth letters of the word OMNISCIENT, which of the following will be the third letter from left of that word? If no such word can be made, give 'J' as the answer and if more than one such word can be made, give 'Q' as the answer. **(IBPS RRB 2013)**
- (a) J (b) Q
(c) I (d) M
(e) S
35. How many such pairs of letters are there in the 'ENIGMATIC' each of which has as many letters between them in the word as in the English alphabet? **(IBPS RRB 2013)**
(a) One (b) Two
(c) Three (d) None
(e) More than five
36. How many such pairs of letters are there in the word TERMINATE each of which has as many letters between them in the word as in the English alphabet? **(IBPS RRB 2013)**
(a) None (b) One
(c) Two (d) Three
(e) More than three
37. If it is possible to make only one meaningful English word with the second, the fifth, the sixth and the tenth letters of the word STREAMLINE, which of the following will be the third letter of that word? If no such word can be made, give 'X' as the answer and if more than one such word can be made, give 'Y' as the answer. **(IBPS RRB 2013)**
(a) E (b) A
(c) M (d) X
(e) Y
38. If it is possible to make only one meaningful English word with the second, the fifth, the seventh and the ninth letters of the word SUBSTANTIAL, which of the following will be the second letter of that word? If no such word can be formed, give '#' as the answer and if more than one such word can be formed, give '@' as the answer. **(SBI SO 2014)**
(a) U (b) T
(c) N (d) #
(e) @
39. How many such pairs of letters are there in the word CHARGED, each of which has as many letters between them in the word as in the English alphabetical series (in both forward and backward directions)? **(SBI SO 2014)**
(a) None (b) One
(c) Two (d) Three
(e) More than three
40. Each consonant in the word BLARING is replaced with the previous letter and each vowel is replaced with next letter in the English alphabetical series and the new letters are rearranged alphabetically. Which of the following will be the third letter from the right end? **(SBI SO 2014)**
(a) K (b) B
(c) M (d) J
(e) F
41. Each vowel of the word BUCK-SHOT is changed to the next letter in the English alphabetical order and each consonant is changed to the previous letter in the English alphabetical order. If the new alphabets thus formed are arranged in alphabetical order (from left to right). Which of the following will be fifth from the right? **(IBPS Clerk 2014)**

- (a) R (b) B
(c) G (d) J
(e) P
42. How many such pairs of letters are there in the words DISPLACED each of which has as many letters between them in the word (in both forward and backward directions) as they have between them in the English alphabetical order? **(IBPS Clerk 2014)**
(a) One (b) Two
(c) Three (d) Four
(e) More than four
43. If the first and second letters in the word DEPRESSION were interchanged, also the third and the fourth letters, the fifth and the sixth letters and so on, which of the following would be the seventh letter from the right? **(SBI Clerk 2014)**
(a) R (b) O
(c) S (d) P
(e) None of these
44. How many such pair of letters are there in the word WONDERS, each of which has as many letters between them in the word (in both forward and backward direction) as they have between them in the English alphabetical order? **(SBI Clerk 2014)**
(a) One (b) Two
(c) Three (d) More than three
(e) None of these
45. If it is possible to form a word with the first, fourth, seventh and eleventh letters of the word 'SUPERFLUOUS', write the first letter of that word. Otherwise, X is the answer. **(SBI Clerk 2014)**
(a) S (b) L
(c) O (d) X
(e) None of these
46. If it is possible to form a word with the first, fourth, seventh and eleventh letters in the word 'SPHERVLVODS' write the second letter of that word. Otherwise, X is the answer? **(IBPS RRB 2015)**
(a) S (b) E
(c) L (d) O
(e) None of these
47. How many meaningful English words can be made with the letters TSFI using each letter only once in each word? **(IBPS RRB 2015)**
(a) None (b) One
(c) Two (d) Three
(e) More than three
48. If it is possible to make any one meaningful word with the first, the second, the fourth and the fifth letters of the word VIOLENCE using each letter only once, which of the following will be the first letter of that word? If only two such words can be formed, give 'P' as the answer. If only four such words can be formed, give 'Y' as the answer. And if no such word can be formed, give 'X' as the answer. **(IBPS RRB 2015)**
(a) P (b) Y
(c) Z (d) X
(e) V
49. The positions of the first and the fourth letters of the word PLANET are interchanged, similarly, the positions of the second and fifth letters and third and sixth letters are interchanged. In the new arrangement thus formed, how many letters are there between the letter which is second from the right and the letter which is fourth from the left according to the English alphabetical order? **(IBPS RRB 2015)**
(a) None (b) One
(c) Two (d) Three
(e) Four
50. The positions of how many alphabets will remain unchanged if each of the alphabets in the word WORTHY is arranged in alphabetical order from left to right? **(IBPS RRB 2015)**
(a) None (b) One
(c) Two (d) Three
(e) More than three
51. How many such pairs of letters are there in the word REASON, each of which has as many letters between them in the word (in both forward and backward directions) as they have between them in the English alphabetical series? **(IBPS RRB 2015)**
(a) None (b) One
(c) Two (d) Three
(e) More than three
52. If it is possible to make only one meaningful word with the second, third, eighth and ninth letters of the word 'CONFLICTED', which would be the second letter of the word from the left? If more than one such word can be formed, give 'A' as the answer. If no such word can be formed, give 'Z' as your answer. **(IBPS PO 2015)**
(a) A (b) T
(c) O (d) N (e) Z
53. If it is possible to make only one meaningful word from the first, the fifth, the seventh, the eighth and the eleventh letters of the word DEPARTMENTAL, first letter of the word is your answer. If more than one such word can be formed, your answer is 'X' and if no such word can be formed, your answer is 'Y' **(IBPS PO - 2015)**
(a) A (b) D
(c) R (d) X (e) Y
54. How many such pairs of letters are there in the word SHOULDER each of which has as many letters between them in the word as in the English alphabet? **(SBI PO 2015)**
(a) None (b) One
(c) Two (d) Three
(e) More than three
55. If it is possible to make only one meaningful English word with the first, the fifth, the seventh and the tenth letters of the word STREAMLINE, using each letter once in each word, which of the following is the third letter of that word? If no such word can be made, give 'X' as the answer and if more than one such word can be made, give 'Y' as the answer. **(SBI PO 2015)**
(a) L (b) E
(c) S (d) X (e) Y
56. How many such pair of numbers are there in the given number "46579739" (Both backward and forward) same as far as according to numeric series? **(IBPS RRB Prelim 2017)**
(a) One (b) Two
(c) Three (d) More than three
(e) None of these.

57. If it is possible to make only one meaningful word with the 2nd, 3rd, 7th and 8th letters of the word 'PRACTICE' which would be the second letter of the word from the right? If more than one such word can be formed give 'Y' as the answer. If no such word can be formed, give 'Z' as your answer. **(IBPS RRB Prelim 2017)**
- (a) Y (b) E
(c) I (d) Z
(e) M
58. How Many such pairs of letters are there in the word 'TRANSFER', each of which has as many letters between them in the word as they have between them in the English alphabet? **(IBPS PO Prelim 2017)**
- (a) None (b) One
(c) Three (d) More than three
(e) Two
59. The second, third, fifth and sixth letter of the word "DESCRIBE" are combined to form a meaningful word. If more than one meaningful word is formed then the answer is X, if no such word is formed then answer is Z? **(IBPS RRB Pre 2018)**
- (a) O (b) X
(c) R (d) Z
(e) C
60. How many such pairs of letters are there in the word "Stranding" having same number of letters between them as they have between them according to the alphabetical order. **(IBPS PO Pre 2018)**
- (a) Two (b) More than Three
(c) Three (d) One
(e) None of these
61. Find the odd one out? **(IBPS PO Pre 2018)**
- (a) JQK (b) BYC
(c) LOM (d) CXD
(e) OPX
62. A set of words are given in each option, you have to first arrange each alphabet according to alphabetical series within the word then by using third letter from each word you have to decide from which set a meaningful word is not formed by rearranging them. **(IBPS PO Mains 2018)**
For example:
(1. TPSOU, RAWTY, OBRHA, OBTAS, GNEBI
First Arrange them in alphabetical order
OPSTU, ARTWY, ABHOR, ABOST, BEGIN
Now using third letter from each word i.e. S, T, H, O, G
Meaningful word will be GHOST.)
- (a) FTEID, MESAT, OCLKP, GSIUD
(b) UGJYL, WTUZ, GERNC, PDOFV
(c) USVH, NDPMH, ETCNB, ITSD, OVEN
(d) QHFWA, MBNRH, SEVJ, TKXGU
(e) None of these
63. How many meaningful words can be made by using letters 'M', 'T', 'A' and 'E', keeping M as the first letter of the word? **(IBPS RRB Clerk Pre 2018)**
- (a) Two (b) One
(c) Three (d) Four
(e) None of these
64. How many words can be formed from the 1st, 6th, 8th and 9th letter of a word 'EMANICIPATE' by using each letter once in the word? **(SBI Clerk Pre-2018)**
- (a) two (b) one
(c) none (d) three
(e) More than three
65. If all the letters in the word FIGURES are arranged in alphabetical order from left to right in such a way that vowels are arranged first followed by consonants, then how many letters are there in between U and R after the arrangement? **(SBI Clerk Pre-2018)**
- (a) two (b) one
(c) none (d) three
(e) four
66. If in the number 39682147, 1 is added to each of the digit which is less than five and 1 is subtracted from each of the digit which is greater than five then how many digits are repeating in the number thus formed? **(SBI Clerk Pre-2018)**
- (a) two (b) one
(c) none (d) three
(e) four
67. Seven letters are arranged in a linear arrangement to form a meaningful word. A is second to the left of I. L is to the left of N. Not more than two letters are placed between I and G. G is placed to the right of I. G is not neighbor of E and D. D and E are placed next to each other. Which letter is placed in exactly middle of the meaningful word so formed. If more than one word is formed mark your option as X? **(IBPS Clerk Main 2019)**
- (a) N (b) L
(c) X (d) E
(e) G
68. If all the letters of each given words are arranged in alphabetical order within the words, then in how many words third and fifth letter remains on the same position as earlier? **(IBPS Clerk Main 2019)**
- I. MBEKTYD
II. GPNAQUS
III. XCJRHO
- (a) Only I (b) Only I and II
(c) All I, II and III (d) Only II
(e) None
69. If all the vowels of the word 'EPISODE' are changed to the letter immediately succeeding them in the english alphabet series and all the consonants are changed to the letter immediately preceding them in the english alphabet series, then how many letters of the new word are similar to the letters of the old word? **(IBPS PO Prelim-2019)**
- (a) One (b) Two
(c) Three (d) More than three
(e) None
70. How many such pairs of letters are there in the word BRISKLY each of which has as many letters between them in the word (in the forward direction) as they have between them in the English alphabetical order? **(IBPS PO Prelim-2019)**
- (a) 1 (b) 2
(c) 3 (d) none
(e) 4

71. In the word 'CHLORINE', how many pairs of the letters have the same number of letters between them in the word as in alphabet? **(IBPS Clerk Prelim-2019)**
 (a) Four (b) Two
 (c) One (d) Three
 (e) More than four
72. If it is possible to make only one meaningful word with the 2nd, 5th, 8th and 9th letters of the word 'TRANSLATION' which would be the second letter of the word from the left? If more than one such word can be formed give 'Y' as the answer. If no such word can be formed, give 'Z' as your answer. **(IBPS Clerk Prelim-2019)**
 (a) Y (b) S
 (c) T (d) Z
 (e) R
73. How many pairs of letters are there in the word 'SEQUENTIAL', each of which have as many letters between them in the word as they have between them in the English alphabet? **(SBI PO Prelim-2019)**
 (a) One (b) Two
 (c) Three (d) Four
 (e) Five
74. In the word 'COMMUNICATION', how many pairs of the letters have the same number of letters between them in the given word as they have in the English alphabet series? **(SBI Clerk Prelim-2019)**
 (a) Four (b) Two
 (c) One (d) Three
 (e) More than five
75. If it is possible to make only one meaningful word with the 1st, 4th, 7th and 11th letters of the word 'INTERPRETATION' which would be the second letter of the word from the right end? If more than one such word can be formed give 'Y' as the answer. If no such word can be formed, give 'Z' as your answer. **(SBI Clerk Prelim-2019)**
 (a) Y (b) E
 (c) M (d) T
 (e) Z
76. In the word 'RELATIONSHIP' all consonants are written as their preceding letter and all vowels are written as their following letters. Now all letters are arranged in alphabetical order from left to right and all the repeated letters are eliminated. Then, how many such pairs of letters are there, each of which have as many letters between them in the word (in both forward and backward direction) as they have between them in the English alphabetical series? **(SBI Clerk Main-2019)**
 (a) Seven (b) Six
 (c) Four (d) Three
 (e) More than eight
77. If we form the word by 1st, 3rd and 5th letter of 'CELEBRATE' and 1st and 4th letter of 'ALIKE' then, what will be the 3rd letter from right? **(SBI Clerk Main-2019)**
 (a) B (b) A
 (c) L (d) E
 (e) None of these
78. How many pairs of letters are there in the word 'EDUCATION', each of which have as many letters between them in the word as they have between them in the English alphabet? **(IBPS RRB PO Prelim-2019)**
 (a) Five (b) Two
 (c) Three (d) Four
 (e) None of these
79. If four letter word is formed from 1st, 3rd, 5th and 6th letter of TRANSLATE then what is the 3rd letter of newly formed word? If more than one meaningful word is formed, then the answer will be Z. **(IBPS RRB PO Prelim-2019)**
 (a) L (b) T
 (c) A (d) S
 (e) Z
80. In a certain code NATIONAL is written ALTINAON then in than in the same code how DAUGHTER is written. **(IBPS RRB PO Main-2019)**
 (a) AUTHDGER (b) ERDAUGHT
 (c) ERUGDAHT (d) HTERUGDA
 (e) None of these
81. How many pairs of letters are there in the word "MINUTE" each of which have as many letters between them in the word as they have between them in the English alphabetical series? **(IBPS RRB Clerk Prelim-2019)**
 (a) Three (b) One
 (c) Two (d) More than three
 (e) None
82. From the letters of the given word "ONEROUS" What is second letter of the meaningful English word that can be formed from the first, third, fourth and seventh letter of the above given word? If no such word can be formed then mark your answer as 'N', if more than one word can be formed then mark your answer as 'M'. **(IBPS RRB Clerk Main-2019)**
 (a) R (b) S
 (c) M (d) N
 (e) O

Answers & Explanations

1. (b) Meaningful Word \Rightarrow FONT

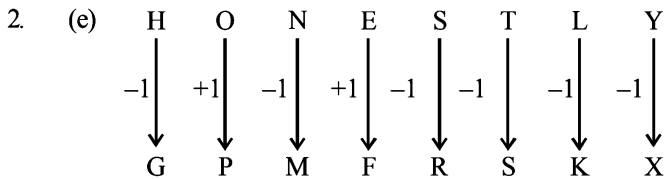

F G K M P R S X

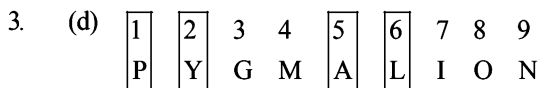

Meaningful Word \Rightarrow PLAY

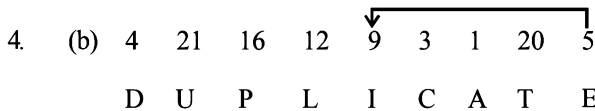

5. (d) Meaningful words \Rightarrow IDLE, LIED | DIEL,

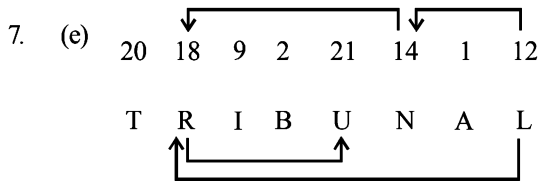

8. (c) Meaningful Words from LGEU are \Rightarrow GLUE, LUGE

9. (b) Specified letters are E, I, S and D respectively. The meaningful word that can be formed using these letters once is SIDE.

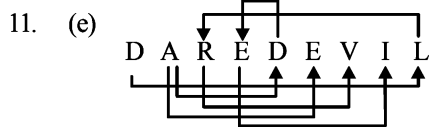
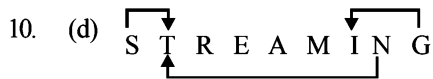

There are seven such pairs,

12. (e) The specified letters are T, E, A and S respectively, Meaningful words are SEAT and EAST

13. (e) Second, fourth, fifth and seventh letters are O, R, T, and S respectively. Words, that can be formed with these letters are SORT and ROT.

14. (b) The third, fifth, seventh and ninth letters are W, G, A, and E respectively. Only one meaningful word can be formed using these letters which is WAGE.

15. (b) Second, Fourth, sixth and seventh letters of word "STUMBLE" are T, M, L & E respectively and meaningful word made by these letter is 'MELT'

16. (e) According to question.

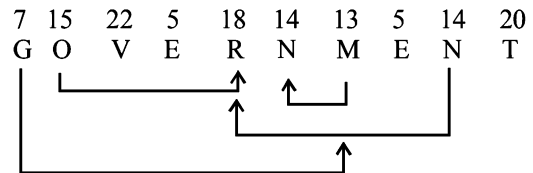

Such couple are G - M, O - R, M - N and N - R and is more than three.

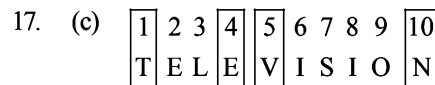

Meaningful Word \Rightarrow VENT

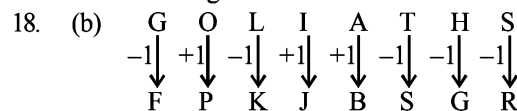

B F G J K P R S
Sixth from the left

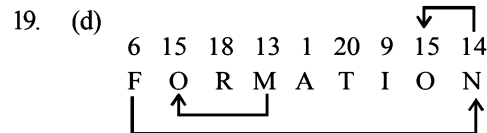

20. (b) Meaningful Word \Rightarrow ACID

21. (c) Meaningful Words \Rightarrow CONE, ONCE

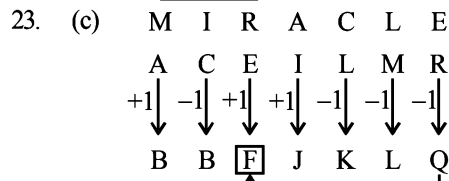

5th from the right

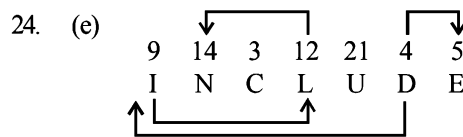

25. (b) 22 9 18 20 21 1 12
V I R T U A L

26. (b) Meaningful word \Rightarrow LIP

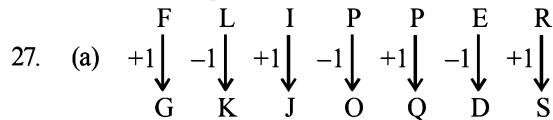

28. (b) Meaningful Word ⇒ COPY

29. (c) After rearrangement

A B L E S U I T
 3rd from left 2nd from right

30. (b) 16 1 3 11 5 20 19
 P A C K E T S

31. (d) W O N D E R S

32. (d) 19 21 2 19 20 1 14 3 5
 S U B S T A N C E

33. (b) 1 2 3 4 5 6 7 8 9
 S T E A D F A S T
 Meaningful Word ⇒ DATE

34. (e) 1 2 3 4 5 6 7 8 9 10
 O M N I S C I E N T
 Specified letters ⇒ M, S, I, T
 Meaningful word
 ⇒ M I S T
 Third letter

35. (a) 5 14 9 7 13 1 20 9 3
 E N I G M A T I C

36. (c) 20 5 18 13 9 14 1 20 5
 T E R M I N A T E

37. (e) 1 2 3 4 5 6 7 8 9 10
 S T R E A M L I N E
 Meaningful words ⇒ MATE, MEAT, TEAM, TAME

38. (c) 1 2 3 4 5 6 7 8 9 10 11
 S U B S T A N T I A L
 Specified letters ⇒ U, T, N and I
 Meaningful word ⇒ UNIT

39. (d) 3 8 1 18 7 5 4
 C H A R G E D
 So, 3 such pairs are there.

40. (a) B L A R I N G
 -1 ↓ -1 ↓ +1 ↓ -1 ↓ +1 ↓ -1 ↓ -1 ↓
 A K B Q J M F
 Now,
 A B F J K M Q
 3rd from right

41. (d) After shifting,

B U C K S H O T
 ↓ ↓ ↓ ↓ ↓ ↓ ↓ ↓
 A V B J R G P S

After arranging in alphabet sequence.

A V B J R G P S
 ↓ ↓ ↓ ↓ ↓ ↓ ↓ ↓
 A B G J P R S V

Hence, letter J will be fifth from the right.

42. (c) D I S P L A C E D

There are three such pairs of letters i.e., IL, AD and DE. Which has as many letters between them in the word.

43. (d) The new letter sequence is EDRPSEISNO.
 The seventh letter from the right is P.

D E P R E S S I O N

1 2 3 4 5 6 7 8 9 10

44. (d) DE, NO, RW, RS (4 pair of letters) have as many letters between them as in English alphabets.

45. (b) The word from I, IV, VII, XI letters (S, E, L, S) is LESS.

46. (b) The first, fourth, seventh and eleventh letters of the word 'SPHERVLVODS'
 The word formed is LESS
 The second letter is E.

47. (c) FIST, SIFT

48. (b) Here specified letters are: V, I, L and E. Words formed with these letters are as follows:
 1. EVIL 2. LIVE
 3. VEIL 4. VILE

49. (d) P L A N E T
 N E T P L A
 L M N O P

50. (e) W O R T H Y
 H O R T W Y

51. (b) 18 5 1 19 15 14
 R E A S O N

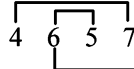
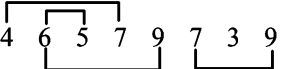

52. (a) 1 2 3 4 5 6 7 8 9 10
 C O N F L I C T E D
 Meaningful words ⇒ Note, Tone

53. (b) 1 2 3 4 5 6
D E P A R T
7 8 9 10 11 12
M E N T A L

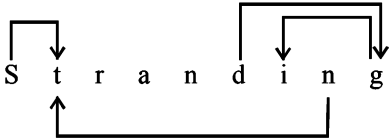
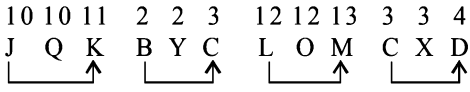
- Specified letters ⇒ D, R, M, E, A
Meaningful word ⇒ DREAM
54. (b) S H O U L D E R

55. (e) Meaningful words
SALE, SEAL
 1 2 3 4 5 6 7 8 9 10
 S T R E A M L I N E

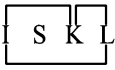
56. (d) 4 6 5 7 9 7 3 9

57. (a) Race, Care
 58. (c) 'AE, EF, NR'
 59. (b) 3rd, 5th, 6th and 8th letters are E, S, R, I. The meaningful words formed are RISE, SIRE

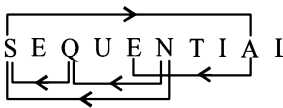
60. (b) S t r a n d i n g

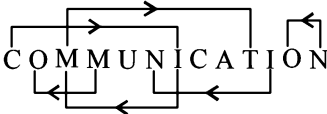
61. (e) 10 10 11 2 2 3 12 12 13 3 3 4
 J Q K B Y C L O M C X D

 15 11 24
 O P X

Here, option (e) is odd. As first and third alphabet have immediate place value & the second alphabet has reverse place value of first one.

62. (d) From (a) FILM
 (b) GLOW
 (c) MOUSE
63. (c) MATE, MEAT, META
64. (a) The 1st, 6th, 8th and 9th letter of a word 'EMANICIPATE' are E, C, P, A So, the words formed are PACE and CAPE
65. (a) The given word is - FIGURES
 After the rearrangement - EIUFGRS
 So, the letters between U and R will be two.
66. (b) The given number is - 39682147
 After applied operation - 48573256
 So, only digit 5 is repeated in the number thus formed.
67. (c) ALIGNED, DEALING
68. (d) I MBEKTYD - BDEKMTY
 II GPNAQUS - AGNPQSU
 III XCJRHO - CHJORX
69. (e)
70. (c) B R S K L Y

71. (c) C H L O R I N E

72. (c) "STIR"
73. (e) S E Q U E N T I A L

74. (e) C O M M U N I C A T I O N

75. (a) Two word formed TIER, RITE
 76. (e) RELATIONSHIP

Step I: QFKBSJPMRGJO
 Vowel → following letters
 Consonant → Preceding letters

Step II: BFG JJ KMOPQRS

(Alphabetical order arrangement)

Step III: BFGKMOPQRS

(Eliminate repeated letters JJ)

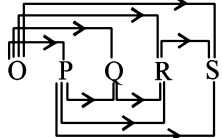
Step IV: B F G K M O P Q R S

77. (b) From CELEBRATE
 Step I: 1st, 3rd and 5th letters are C, L, B
 Now,
 From ALIKE
 Step II: 1st and 4th letters are A, K
 New word is BLACK
 Hence, A will be the 3rd from the right.

78. (a) E D U C A T I O N

79. (e) Meaningful words from letter T, A, S and L are SALT and LAST.

80. (c) ERUGDAHT
 NATIONAL (NA = 1, TI = 2, ON = 3 and AL = 4)
 similarly for DAUGHTER (DA = 1, UG = 2, HT = 3 and ER = 4) and then arrange them in 4213 order.

81. (c) M I N U T E

Two pairs of letters.

82. (c) First, third, fourth and seventh letters of ONEROUS are O, E, R and S.

Meaningful English words are - ROSE - A flower.

SORE - Painful, Aching.

ORES - Raw metal

As three meaningful English words can be formed, thus M would be the answer.