

Direction (1-8): Read the given passage carefully and answer the questions that follow:

Sustainable financing of infrastructure projects in India has triggered much debate over the last two decades. Over time and across governments, there are two strands that have endured. Getting private money with a long-term horizon is essential as governments don't have the fiscal space to do it on their own. And, **the quantum of private money that may (A)/ came in is influenced by the extent (B)/ to which infrastructure financing (C)/ is insulated from political risks. (D)/ No error (E)**

Gol has launched the National Monetisation Pipeline (NMP), which aims to monetise assets without transferring ownership. The goal is to raise Rs 6 lakh crore over four years. To put it in context, it's a little less than the Rs 6.45 lakh crore PSUs contributed towards capital expenditure in Gol's budget for 2020-21. Perhaps, to **mitigate** political risks, NMP classifies land and buildings as non-core assets. That leaves mainly roads, railways, airports and pipelines that are already built as the core assets that will be monetised. NMP resource mobilisation rests mainly on roads (27%) and railways (25%) to mop up resources.

The key to success lies in the way the deals are structured. Basic models here are not new. The main model **envisages** a contract between Gol and a private entity to operate an asset for a specified

period. Among the better-known examples are the PPPs in 2006 of New Delhi and Mumbai airports under an operate, maintain and develop model. Another successful model is the one used in 2018 for national highways called operate, maintain and transfer. The alternative model, which is also in use, mimics a mutual fund. Power Grid Corporation, for example, raised funds this year for earmarked projects through an Infrastructure Investment Trust IPO.

1) What is the goal of the project launched by the government of India?

- A. To enhance interaction and to become more digitally inclusive.
- B. To monetize assets without transferring ownership.
- C. to build better relationships with other stakeholders
- D. to monitor the performance of the country in 29 select global indices
- E. None of these

2) What does the main model anticipate?

- A. Support services for States/UTs for infrastructure projects.
- B. Verticals within NITI Aayog for action taken on issues raised by the States in the Governing Council meetings.

IDBI Executive Previous Year Paper – English Version

C. continuous support to all Ministries, Departments, organisations, and institutions in identifying and adopting best practices.

D. Examination of various project proposals for Standing Finance Committee/Expenditure Finance Committee's consideration.

E. A contract between the Govt and a private entity to operate an asset for a particular time frame.

3) How does the National Monetisation Pipeline decrease political risks?

A. By examining proposals for external assistance funding in the water and land resources sector.

B. By classifying land and buildings as core assets.

C. Non-core assets are defined as land and buildings by NMP.

D. NMP raises funds for earmarked projects through an Infrastructure Investment Trust IPO.

E. None of these

4) Which of the following is the primary driver of NMP resource mobilisation?

A. airports and pipelines

B. roads and railways

C. railways and airports

D. pipelines and railways

E. None of these

5) Through which of the following, Power Grid Corporation raised funds for earmarked projects?

A. Quantum of private money

B. Infrastructure mobilization NMP

C. Resource mobilization IPO

D. Infrastructure Investment Trust IPO

E. Infrastructure financing NMP

6) The given sentence may or may not be grammatically correct. Choose the part that contains errors. If the sentence is free from error, choose option E 'no error' as your answer.

The quantum of private money that may (A)/ came in is influenced by the extent (B)/ to which infrastructure financing (C)/ is insulated from political risks. (D)/ No error (E)

A. A

B. B

C. C

D. D

E. No error

7) What is the SYNONYM of the word 'envisage' used in the given passage?

A. Forecast

B. Oversee

C. Neglect

D. Disregard

E. None of these

8) What is the ANTONYM of the word 'mitigate' used in the given passage?

IDBI Executive Previous Year Paper – English Version

- A. Alleviate
- B. Reduce
- C. Diminish
- D. Aggravate
- E. None of these

Direction (9-13): Each sentence may or may not replace the word/phrase printed in bold. Mark the correct option to make the sentence meaningfully and contextually correct.

9) Since Rahul did not want to be disturbed while studying, he left the phone **of hooks**.

- A. Off the hook
- B. Off hooking
- C. For the hook
- D. Of hook
- E. No correction required

10) As Paul was overburdened with work, Tanya decided to **give her hand**.

- A. Giving hands
- B. Give her a hand
- C. Giving her handful
- D. Gave her hands
- E. No correction required

11) But equally, it should be made clear that there is no escape for those who **take justice to their own hand**.

- A. Take justice into own hands

- B. Taken justice onto their own hand
- C. Take justice into their own hands
- D. Take justices into their own hands
- E. No correction required

12) There is **an urgent need to look at** alternative sources of potable water in places where quality has deteriorated sharply.

- A. always urgent need to look for
- B. an urgent need to looking at
- C. a urgency to look on
- D. an urgent need to look for
- E. No correction required

13) The politician wanted to **strike balance between** withholding his position and getting into a rapid exchange of opinions.

- A. strike a balance between
- B. striking balance among
- C. have stroked a balance between
- D. having strike between
- E. No correction required

Direction (14-18): In each of the questions below, a sentence is given with two blanks that indicate that some parts are missing. Identify the correct pair of words that fit in the sentence to make it grammatically and contextually correct.

14) The wastage from the chemical industry combined with open sewers, open defecation and

IDBI Executive Previous Year Paper – English Version

_____ made living condition quite _____
at one in time.

- A.Litter, atrocious
- B.Trash , hateful
- C.Debris , shocking
- D.Littering , appalling
- E.Besmirch , admirable

15) Even after double close vaccination, people can get _____ infections and can still be _____ carriers and spread the infection; hence masking is important even after double vaccination.

- A.Transmuted , transmission
- B.Breakthrough , asymptomatic
- C.Mutated , symptomatic
- D.Improved , asymptomatic
- E.Advanced , indicative

16) The act of covering face has not only _____ us into a surreal world of faceless morons but also become a _____ for the borderland between the dead and the living.

- A.Guide , version
- B.Shun , emblem
- C.Ushered , totem
- D.Dodge , figurative
- E.Take , illustration

17) The human right to dream must remain a struggle to overcome all nightmares, particularly

those _____ justified by market fundamentalism and manufactured by _____ global corporate governance.

- A.Assiduously , profligate
- B.Latently , prudent
- C.Attentively , Frugal
- D.Passively , unprincipled
- E.Sedulously , upright

18) There is increasingly an acute consciousness in much of the corporate world in the USA that racial _____ is systematic, widespread and _____ which disadvantages Blacks and ethnic minorities at every step of corporate ladder.

- A.Disfavour , Deceptive
- B.Secern , mendacious
- C.Confound , deceitful
- D.Discrimination , insidious
- E.Demarcation , straightforward

Direction (19-23): In the following questions, some part/parts of the sentence have errors. Find out which part(s) of the sentence have error(s) and select the appropriate option. If a sentence is free from error, select 'E'

19) The 2020-21 Index drops several economical indicators and gives (A)/ greater weightage to social equality indicators such as representation of women (B)/ and people from marginalized communities in legislatures and (C)/ local

IDBI Executive Previous Year Paper – English Version

governance institutions, and crimes against SC/ST communities.(D)/ No error (E)

- A.AB
- B.AD
- C.Only C
- D.Only A
- E.No error

20) Farmers burnt copies of the Centre's three farm laws (A)/ near residences of BJP leaders and at other places in Punjab on Saturday (B)/ as they observed 'Sampoorna Kranti Diwas' to mark the day when (C)/ these legislations were promulgated as ordinances last year.(D)/ No error (E)

- A.AB
- B.AD
- C.CD
- D.BD
- E.No error

21) In 2013, the Reserve Bank of India has first issued (A)/ a press release cautioning users and investors of virtual currencies, (B)/ and indicated that they were reviewing the legality of such assets (C)/ under the prevailing regulatory frameworks.(D)/ No error (E)

- A.Only A
- B.Only B
- C.Only C
- D.Only D

E.No error

22) One of the reasons as to why India perhaps has been (A)/ leaning towards banning cryptocurrencies are the possibility of the (B)/ cryptocurrencies being used for financing legal activities (C)/ such as funding terror, money laundering, tax evasion, etc. (D)/ No error (E)

- A.Only A
- B.BC
- C.Only C
- D.CD
- E.No error

23) Delhi Chief Minister Arvind Kejriwal on Sunday asked the Prime Minister Narendra Modi (A)/ why the doorstep ration delivery scheme by his government (B)/ was stalled by the Centre and appealed to (C)/ him to allow their implementation in the national interest. (D)/ No error (E)

- A.AD
- B.BC
- C.CD
- D.Only D
- E.No error

Direction (24-28): In the following passage, some of the words are missing. Find the suitable word from the options given below that make the paragraph meaningful.

IDBI Executive Previous Year Paper – English Version

Coercive vaccination – which involves enforcing mandatory vaccination through physical force or _____ (A) and despite the beneficial effects of increasing vaccine uptake, there's more of a consensus that this strategy should be avoided. Yet, according to Yaqiu Wang, a China researcher for Human Rights Watch, _____ (B) tactics including harassment and spying are being reported in some parts of China. This isn't necessarily an official national policy, Wang explains. But the central government issues tough vaccination quotas for local governments, such as the September 2021 guidelines to vaccinate at least 90% of children in China. "This kind of central government quota/decreed drives up vaccination rate, but sometimes this can result in coercive vaccinations at the local level," says Wang. Even in the absence of physical force, certain penalties for noncompliance with mandates can be _____ (C) – for instance, if substantial fees are levied on people who already find it hard to take the time off work or travel to vaccination sites. This was a bone of contention among silkworm growers in the 19th Century and remains an obstacle for some people who have not yet been vaccinated today. With careful and judicious use, the benefit from using those mandates will _____ (D) the harms," he says. Whether that is enough to convince the _____ (E), remains to be seen.

24) Which of the following options will come in blank (A)?

- A.Menace
- B.Intimidation
- C.Emboldening
- D.Compelling
- E.Solace

25) Which of the following options will come in blank (B)?

- A.Demanding
- B.Discretionary
- C.Obligatory
- D.Coercive
- E.peremptory

26) Which of the following options will come in blank (C)?

- A.Counter productive
- B.Counter instance
- C.Counterforce
- D.Counter violence
- E.Counter plotting

27) Which of the following options will come in blank (D)?

- A.Redress
- B.Outbalance
- C.Succumb
- D.Outweigh

IDBI Executive Previous Year Paper – English Version

E.Dwarf

28) Which of the following options will come in blank (E)?

A.Agnostics

B.Audience

C.Misanthropists

D.Scoffers

E.Skeptics

Direction (29-32): In the following questions two columns are given containing three Sentences/phrases each. A sentence/phrase from the first column may or may not connect with another sentence/phrase from the second column to make a grammatically and contextually correct sentence. Each question has five options, four of which display the sequence(s) in which the sentences/phrases can be joined to form a grammatically and contextually correct sentence. If none the options given forms a correct sentence after combination, then mark option (E) i.e. “None of these” as your answer.

29)

COLUMN I	COLUMN II
A. BSE has signed an MoU with All India MSME Association (AIMA MSME), to encourage	D. with the issue subscribing 6.62 times on the last day.
B. India has recently said it expects Pakistan to allow a visit this month by a group of 1,500 pilgrims on the occasion of Gurupurab or birth anniversary of Guru Nanak,	E. through the Attari-Wagah integrated check post in coordination with the Pakistani side.
C. Land travel between India and Pakistan is since being conducted on a limited scale	F. following the denial of permission for visits by two other groups earlier this year.

A.A-E

B.A-D & B-F

C.B-F & C-E

D.B-E

E.A-D & C-E

30)

IDBI Executive Previous Year Paper – English Version

COLUMN I	COLUMN II
A. Amritsar Farmers residing in the border areas of Punjab, under the banner of Border Area Sangharash Committee (BASC), protested outside	D. the Border Security Force (BSF)'s Khasa headquarters in Amritsar on Thursday against the extension of the force's jurisdiction.
B. A Hong Kong pro-democracy activist, who was dubbed 'Captain America 2.0'	E. for wielding the superhero's shield at protests, was jailed on Thursday for near six years.
C. The Centre should focus on the 15-km jurisdiction to curb the smuggling bid from	F. across the border and release compensation of the border farmers.

A.A-D & B-E

B.B-E

C.A-D, B-E & C-F

D.C-F

E.A-D & C-F

31)

COLUMN I	COLUMN II
A. Nykaa founder Falguni Nayar became India's seventh woman billionaire and the wealthiest self-made billionaire	D. the world's first anti-Covid pill approved in the United Kingdom, for the treatment of Covid-19 in adults in India.
B. The UPI AutoPay facility has seen widescale adoption by consumers as the norms for standing instructions	E. for recurring payments of the Reserve Bank of India kicked in from October 1.
C. The Drugs Controller General of India is reviewing the clinical data of molnupiravir,	F. in an ongoing IPO boom which saw the e-commerce giant making a blockbuster debut on Dalal Street

A.B-E & C-D

B.A-F & B-D

C.A-F

IDBI Executive Previous Year Paper – English Version

D.A-F & B-E

E.A-F, B-E & C-D

32)

COLUMN I	COLUMN II
A. India's early exit from the ongoing T20 World Cup has not surprisingly led	D. which is under consideration of the Joint Parliamentary Committee.
B. To strengthen data privacy, the government has introduced the Personal Data Protection Bill, 2019,	E. of proper waste management/processing systems.
C. Waste generation is an acute problem, arising from the lack	F. to a lot of hand ringing and finger pointing.

A.A-F & B-D

B.B-D & C-E

C.A-F

D.A-F, B-D & C-E

E.B-D

Direction (33-37): In the questions given below, a sentence has been broken down into four fragments labelled (A), (B), (C) and (D) and arranged, not necessarily in the correct order. You have to find the correct order of arrangement from the options given below. In case, the sentence is correct in its original form, please select (E) as your answer.

33) To partner with international (A)/peers across cultures on the (B)/future education requires students (C)/internet and in visual classrooms (D)

A.DCBA

B.CABD

C.CADB

D.ACBD

E.No rearrangement required

34) and beyond the inclusion of women as beneficiaries (A)/gender and sanitation means going (B)/of meeting programme objectives,(C)/beyond the instrumental objectives (D)

A.BDCA

B.CBDA

IDBI Executive Previous Year Paper – English Version

C.BADC

D.CBAD

E.No rearrangement required

35) By misguided enthusiasm and wasted energy (A)/the guidelines were an unhappy blend (B)/of power and passion trying to supersede (C)/the lack of attributes explained (D)

A.ABDC

B.DBCA

C.BDAC

D.BCDA

E.No rearrangement required

36) multinational cyber security firms to issue timely alerts on ransom ware (A)/so the government is reportedly working closely with (B)/India is the second most targeted country (C)/for ransom ware after the US and (D)

A.CABD

B.CBDA

C.CDBA

D.ACBD

E.No rearrangement required

37) large entities because of the (A)/the banks are reluctant to lend to (B)/ accumulation of stressed assets over the (C)/ past five years independent of the pandemic (D)

A.CBDA

B.BACD

C.DBAC

D.BCAD

E.No rearrangement required

Direction (38-42): Rearrange the following sentences (P), (Q), (R), (S) and (T) in proper sequence to form a meaningful paragraph; then answer the questions given below them.

P Earlier, Boeing first filed with the FCC in 2017 seeking approval to deploy a V-band Constellation of mostly low earth orbit satellites.

Q The Federal Communications Commission (FCC) has approved Boeing Co's (BA.N) application to launch and operate 147 satellites to provide high-speed broadband internet access.

R But now, there is a growing effort to deploy satellite-based internet service and thus the approval has been given.

S It was because of the fact that Elon Musk's SpaceX urged the FCC to reject Boeing's plan saying it presented a "clear danger of harmful interference" to other systems .

T At that time, The FCC did not approve Boeing's request to operate inter-satellite links in certain frequency bands that are not allocated internationally for operations of the fixed-satellite service.

IDBI Executive Previous Year Paper – English Version

38) Which of the following will be the **FIRST** sentence after rearrangement?

- A.P
- B.Q
- C.R
- D.S
- E.T

39) Which of the following will be the **LAST** sentence after rearrangement?

- A.P
- B.Q
- C.S
- D.R
- E.T

40) Which of the following will be the **SECOND** sentence after rearrangement?

- A.Q
- B.P
- C.R
- D.S
- E.T

41) Which of the following will be the **THIRD** sentence after rearrangement?

- A.P
- B.Q
- C.S
- D.T

E.R

42) Which of the following will be the **FOURTH** sentence after rearrangement?

- A.P
- B.Q
- C.R
- D.S
- E.T

Direction (43-47): In the following passage, some of the words are given in **bold**, each of which is preceded by a blank. Find the suitable word from the options given below that could replace the bold word so as to make the paragraph meaningful. If no replacement is required, choose (E), as your answer.

As per data compiled by the National Crime Records Bureau (NCRB) in the report Crime in India 2020, about 5% of the cases under Section 498A were found to be false. About 9.4% were either non-cognizable or civil in nature or with insufficient evidence in the end. Similarly, about 12% of the cases under the SCs and STs (Prevention of Atrocities) Act were found to be false by the police, and about 7% were either non-cognizable or civil in nature or with _____ (**Deficient**) (**A**) evidence in the end.

Further, out of the 17,765 cases under Section 498A decided by the courts, 3,425 cases ended

IDBI Executive Previous Year Paper – English Version

with a conviction. Out of the 8,138 cases under the SCs and STs (Prevention of Atrocities) Act decided by the courts, 3,588 cases ended with a _____ (Persuasion) (B). Although there are varied reasons for _____ (Clearing) (C), including a delay in lodging the FIR, witnesses turning hostile, compromise between the parties, lack of proper presentation by the prosecution and an appreciation of the evidence by the court, etc., the problem arises when a court concludes that a case is false.

Since the _____ (Albatross) (D) of arriving at the truthfulness of a case lies primarily with the investigating officer, it is their duty to investigate the case thoroughly and collect all the facts and circumstances fearlessly. This would ensure that false cases are closed in time and no innocent individuals have to suffer the _____ (Rigours) (E) of the law

43) Which of the following options will replace the word A?

- A. Copious
- B. Insufficient
- C. Abundant
- D. Sufficient
- E. No replacement required

44) Which of the following options will replace the word B?

- A. Tenet

- B. Dogma
- C. Misgiving
- D. Conviction
- E. No replacement required

45) Which of the following options will replace the word C?

- A. Incrimination
- B. Impeachment
- C. Acquittal
- D. Accusation
- E. No correction required

46) Which of the following options will replace the word D?

- A. Onus
- B. Blame
- C. Stigma
- D. Shame
- E. No correction required

47) Which of the following options will replace the word E?

- A. Rigorous
- B. Strict
- C. Severe
- D. Stern
- E. No replacement required

IDBI Executive Previous Year Paper – English Version

Direction (48-50): In the following questions, two statements are given. Mark the correct connector from the given options which can connect both the sentences in a contextually and grammatically correct manner.

48) (I) Private hospitals have been vaccinating thousands of beneficiaries in Pune, government sites have been vaccinating fewer numbers.

(II) Government sites have more vaccination centers open.

- A. Despite
- B. Furthermore
- C. As
- D. Because
- E. None of these

49)

(I) A division bench comprising Justice Ravi Malimath and Justice Jyotsna Rewal Dua passed these orders on public interest litigation.

Direction (51-55): Read the following information carefully and answer the questions.

The given bar graph shows the average number of Yamaha and Honda bikes manufactured in five different months i.e. January, February, March, April and May and also the number of Yamaha bikes manufactured is more than that of Honda bikes.

(II) The petitioner has alleged that the toll plaza at Sanwara is illegal.

- A. Whereas
- B. Wherein
- C. Whoever
- D. Nevertheless
- E. None of these

50)

(I) Indian shares ended at a record high on Monday, buoyed by hopes that the economy would return to normal.

(II) Some states eased lockdowns, with daily Covid-19 cases hitting a two-month low.

- A. As
- B. In spite of
- C. So
- D. Because
- E. None of these

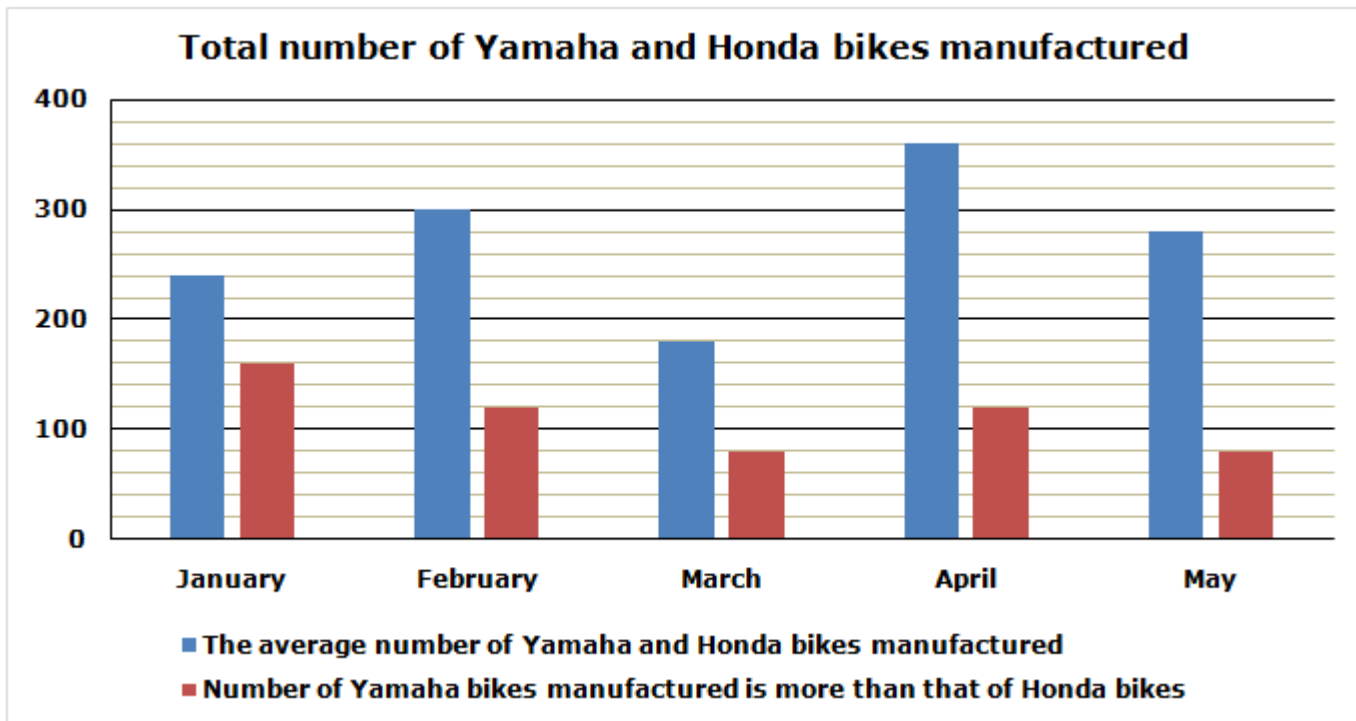

Note: Total number of bikes manufactured=Number of Yamaha bikes manufactured +Number of Honda bikes manufactured.

51) If the number of Yamaha bikes manufactured in June is 25% less than that of January and the total number of bikes manufactured in June is three times the number of Honda bikes manufactured in January, then find the number of Honda bikes manufactured in June?

- A.440
- B.150
- C.240
- D.320
- E.None of these

52) Number of Yamaha bikes manufactured in March and May together is how much more than

the number of Honda bikes manufactured in February and March together?

- A.160
- B.210
- C.100
- D.250
- E.None of these

53) Out of the total number of bikes manufactured in April, 75% of bikes are sold. If the ratio of number of Yamaha bikes sold to unsold in April is 5:2 respectively, then find the number of Honda bikes in April that are unsold?

- A.20

IDBI Executive Previous Year Paper – English Version

- B.40
- C.80
- D.60
- E.None of these

54) Find the ratio of the number of Honda bikes manufactured in February and April together and total number of bikes manufactured in March?

- A.1:1
- B.3:2
- C.5:4
- D.8:7
- E.None of these

55) Find 60% of the sum of the number of Yamaha bikes manufactured in February, April and May together?

- A.540
- B.720
- C.360
- D.660
- E.None of these

Direction (56-65): What approximate value should come in the place of(?) in the following questions.

56) $711.93 \div \sqrt{65} + 19.91\% \text{ of } 199.89 = ? + \sqrt{840}$

- A.70
- B.80
- C.90
- D.100

E.110

57) ? % of 3499 = $1684.02 - 487.998 - 31.32\% \text{ of } 1600.32$

- A.35
- B.20
- C.25
- D.40
- E.None of these

58) ? * 23.02 = $24.34 * 45.01 + 820 - 59.89\% \text{ of } 2400.4$

- A.40
- B.15
- C.30
- D.20
- E.None of these

59) $?^2 = 210\% \text{ of } 799 + (37.99)^2 + 108 * 9.03$

- A.44
- B.56
- C.64
- D.66
- E.None of these

60) $31.11 * 5.98 + 1170.12 \div \sqrt{1520} - 1199.98 \div 15.15 = ?$

- A.160
- B.153
- C.146
- D.176

IDBI Executive Previous Year Paper – English Version

E.136

61) 17.5% of $319.912 - 39.98\%$ of $\sqrt{4220} = ?$

A.20

B.25

C.30

D.35

E.15

62) 24.89% of $432.21 * 24.96 = ?$

A.1400

B.2700

C.2500

D.2900

E.None of these

63) 25.25% of $320.19 + 111.98 - \sqrt{3135} = ?$

A.126

B.130

Direction (66-70): Read the following information carefully and answer the questions.

The given pie chart shows the percentage distribution of total number of students who appeared for five different common eligibility tests i.e. TNEB, SSC, RRB, TNPSC and JEE in 2020.

Total number of students who appeared for common eligibility test=2500

C.136

D.152

E.146

64) $\sqrt{65} * (1015.18 \div 28.91) = ? * 7.12$

A.42

B.45

C.40

D.35

E.30

65) $12.981 * \sqrt{575} * 4.99 - 4480.12 \div \sqrt{63} = ?^3$

A.10

B.15

C.12

D.18

E.20

% distribution of total number of students who appeared for common eligibility test

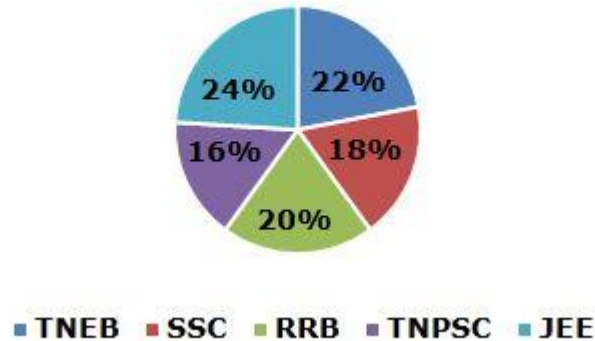

66) Out of the total number of students who applied for the JEE exam, 75% of students appeared on the exam. If the number of boys who applied for the JEE exam is 200 more than that of girls, then find the number of boys who applied for the JEE exam?

- A.400
- B.700
- C.300
- D.500
- E.None of these

67) If the ratio of total number of students who appeared for the SSC exam in 2020 and 2021 is 5:7 respectively, then total number of students who appeared for the SSC exam in 2021 is what percentage more than total number of students who appeared for the RRB exam in 2020?

- A.26%
- B.32%
- C.14%

- D.45%
- E.None of these

68) Find the difference between the total number of students who appeared for the SSC and TNPSC exams and the total number of students who appeared for the JEE exam?

- A.360
- B.250
- C.420
- D.540
- E.None of these

69) Total number of students who appeared for the TNEB exam is what percentage less than the total number of students who appeared for the TNPSC and JEE exam?

- A.55%
- B.25%
- C.45%

IDBI Executive Previous Year Paper – English Version

- D.65%
- E.None of these

70) If the total number of students who appeared for the NTPC exam is 20% less than that of TNEB in which 75% are boys, then find the number of girls who appeared for the NTPC exam?

- A.190
- B.170
- C.150
- D.110
- E.None of these

Direction (71-75): Following question contains two equations as I and II. You have to solve both equations and determine the relationship between them and give an answer as,

71)

I) $x^2 - 21x + 104 = 0$
II) $y^2 - 19y + 84 = 0$

- A. $x > y$
- B. $x \geq y$
- C. $x = y$ or relationship can't be determined.
- D. $x < y$
- E. $x \leq y$

72)

I) $x^2 + 10x - 231 = 0$
II) $y^2 - 6y - 216 = 0$

- A. $x > y$

- B. $x \geq y$
- C. $x = y$ (or) relationship can't be determined.
- D. $x < y$
- E. $x \leq y$

73)

I) $4x^2 - 25x + 36 = 0$
II) $y^2 + 476 = 512$

- A. $x > y$
- B. $x \geq y$
- C. $x = y$ (or) relationship can't be determined.
- D. $x < y$
- E. $x \leq y$

74)

I) $x^2 - 40x + 384 = 0$
II) $y^2 - 26y = -168$

- A. $x > y$
- B. $x \geq y$
- C. $x = y$ or relationship can't be determined
- D. $x < y$
- E. $x \leq y$

75)

I) $x^2 + 7x + 12 = 0$
II) $y^2 - 2y - 15 = 0$

- A. $x > y$
- B. $x \geq y$
- C. $x = y$ or relationship can't be determined
- D. $x < y$

IDBI Executive Previous Year Paper – English Version

E. $x \leq y$

Direction (76-80): Read the following information carefully and answer the questions.

The table chart shows the total number of students who are learning dance in five different institutes i.e. A, B, C, D and E and also given the ratio of the number of boys and girls who are learning dance in five different institutes.

Institutes	Total number of students who are learning dance	Ratio of number of boys and girls who are learning dance
A	480	7:5
B	540	5:4
C	630	1:2
D	340	7:3
E	750	4:11

76) Out of the total number of students in institute A, 60% are learning dance and the remaining students are learning music. If the ratio of the number of boys who are learning dance and music in institute A is 7:5, then find the number of girls who are learning music in institute A?

- A.150
- B.180
- C.120
- D.160

E.None of these

77) Number of boys who are learning dance in institutes A and E is how much more/less than the number of girls who are learning dance in institute C?

- A.60 more
- B.40 less
- C.80 more
- D.50 less
- E.None of these

78) If the number of girls who are learning dance in institute F is 40% less than that of institute E which is 55% out of total number of students learning dance in institute F, then find the difference between the number of boys learning dance in institutes F and E?

- A.110
- B.70
- C.170
- D.90
- E.None of these

79) Find the ratio of the sum of the number of girls who are learning dance in institutes A and E together and the number of boys who are learning dance in institute B?

- A.9:5
- B.7:8

IDBI Executive Previous Year Paper – English Version

- C.4:3
- D.5:2
- E.None of these

80) Number of girls who are learning dance in institute C is what percentage less than the sum of the number of boys who are learning dance in institutes B and E together?

- A.40%
- B.21%
- C.16%
- D.25%
- E.None of these

Direction (81-85): What value should come in the place of (?) in the following number series?

81) 24, 12, 12, 18, 36, ?

- A.90
- B.72
- C.120
- D.108
- E.96

82) 1, 37, 101, 137, ?, 237

- A.221
- B.216
- C.218
- D.211
- E.201

83) 27, 33, 53, 95, ?, 277

- A.177
- B.183
- C.167
- D.189
- E.191

84) 1, 13, 37, ?, 121, 181

- A.79
- B.80
- C.73
- D.82
- E.69

85) 7, 102, 187, 262, 327, ?

- A.367
- B.382
- C.376
- D.388
- E.372

86) The ratio of the marked and cost price of the cooker is 5:3. If the shopkeeper offers two successive discounts of 10% and Rs.240 on the marked price of the cooker and the shopkeeper gets the profit of Rs.960, then find the marked price of the cooker?

- A.Rs.4000
- B.Rs.4500
- C.Rs.3500

IDBI Executive Previous Year Paper – English Version

- D.Rs.3000
- E.None of these

87) Tina invested a certain amount in a compound interest scheme at certain rate of interest. He received the total amount at the end of second and third year is Rs.9522 and Rs.10950.3 respectively. Find the amount invested in the scheme.

- A.Rs.7500
- B.Rs.7200
- C.Rs.7800
- D.Rs.8400
- E.Rs.9000

88) In schools A and B, there are 750 students and the ratio of the number of boys and girls in school A is 4:3 respectively. If the average number of boys and girls in school B is 200, then find the number of girls in school A?

- A.150
- B.210
- C.120
- D.270
- E.None of these

89) A bag contains 4 blue pens, 7 red pens and 5 black pens. If 3 pens are picked at random, then find the probability that none of the pens is blue?

- A.16/21
- B.12/22

- C.15/16
- D.11/28
- E.None of these

90) The average age of Anbu and Ezhil after 7 years is 37 years. 5 years ago, the ratio of the ages of Anbu and Ezhil was 2:3. If the ratio of the present age of Ezhil and Tamil is 7:9, then find the ratio of the age of Anbu and Tamil after 10 years?

- A.7:11
- B.5:11
- C.7:12
- D.5:12
- E.None of these

91) A and B started the business with the investment of Rs.3600 and Rs.1320 respectively. After four months, A left and C joined with the investment of Rs.5100. If at the end of the year, the total profit of the business is Rs.7400, then find the profit share of A?

- A.Rs.3600
- B.Rs.900
- C.Rs.1500
- D.Rs.2100
- E.None of these

92) A bus covers a certain distance at the speed of 45 kmph in t minutes and bike covers the same

distance at the speed of 54 kmph in $(t - 40)$ minutes. Find the distance covered by bus?

- A.170 km
- B.180 km
- C.175 km
- D.178 km
- E.181 km

93) Two persons A and B together can do a piece of work in 12 days while with the help of C they can do the work together in 9 days. If B is 20% more efficient than that of C, then find the time taken by A alone to complete the work?

- A.35 days
- B.20 days
- C.30 days
- D.36 days
- E.None of these

94) The marked price of the fridge is Rs.9600 more than that of the cost price. If the shopkeeper offers a discount of 25% on the marked price of the fridge and the shopkeeper gets a profit of 5%, then find the cost price of the fridge?

- A.Rs.18000
- B.Rs.42000
- C.Rs.36000
- D.Rs.24000
- E.None of these

95) Pipe A and B together fill a tank in 8 hours, pipe C alone fills the tank in 16 hours and the efficiency of C is 75% of the efficiency of B. If A, B and C started together to fill the tank after 4 hours pipes B and C closed, then find the time taken by pipe A alone to fill the remaining tank?

- A.9 days
- B.6 days
- C.7 days
- D.3 days
- E.None of these

96) A vessel contains milk and water in the ratio of 11:4 respectively. If 30 liters of mixture is taken out and replaced with 33 liters of water, then the quantity of milk in the final mixture becomes 66.66%. Find the initial quantity of the mixture?

- A.360 liters
- B.210 liters
- C.450 liters
- D.560 liters
- E.None of these

97) The speed of the stream is 12 kmph and the sum of the speed of boats A and B is 70 kmph. If boat A covers 192 km upstream in 12 hours, then find the time taken by boat B to cover 270 km downstream?

- A.5 hours
- B.7 hours

IDBI Executive Previous Year Paper – English Version

- C.3 hours
- D.9 hours
- E.None of these

98) Ratio of the length and breadth of the rectangle is 4:3 respectively and the breadth of the rectangle is 60% of the side of the square. If the sum of the area of the rectangle and square is 925 cm^2 , then find the area of the rectangle?

- A.510 cm^2
- B.420 cm^2
- C.270 cm^2
- D.300 cm^2
- E.None of these

99) Ratio of number of boys and girls in a school is 7:5 respectively. If the difference between 71.42% of boys and 60% girls in the school is 60, then find the average number of boys and girls in the school?

- A.140
- B.160
- C.120
- D.180
- E.None of these

100) The present age of Mala is 25% more than the present age of Kala. Bala is 7 years younger than Kala. If the average of Mala and Kala is $(x + 6)$ years and the age of Bala after 5 years is x years, then find the value of x ?

- A.28
- B.30
- C.32
- D.34
- E.Cannot be determined

Directions (101-105): Study the following information carefully and answer the below questions.

Eight persons- P, Q, R, S, T, U, V, and W are sitting on the square table but not necessarily in the same order. Four persons sitting on the corner and facing the center while four persons sitting on the side and facing outside the center.

S sits third to the left of R who does not sit on the side of the table. V sits second to the right of Q who neither sits adjacent to S nor R. The number of persons sitting between R and V is the same as the number of persons sitting between Q and P. T sits second to the left of U. The number of persons sitting between W and V is one less than the number of persons sitting between S and U when counted from the left of both W and S.

101) Who among the following person sits opposite to V?

- a) S
- b) The one who sits second to the right of W
- c) The one who sits immediate left of U
- d) P
- e) U

102) If one of the neighbors of Q is W, then who among the following person is another neighbor?

- a) S
- b) V
- c) The one who sits second to the left of R
- d) T
- e) The one who sits immediate right of P

103) How many persons are sitting between P and T when counted from the right of P?

- a) One
- b) Four
- c) Three
- d) Two
- e) None

104) What is the position of S with respect to W?

- a) Third to the left
- b) Second to the right
- c) Second to the left
- d) Third to the right
- e) Immediate left

105) Four of the following five are alike in a certain way to form a Group. Find the one which does not belong to the group?

- a) V
- b) Q
- c) The one who sits immediate right of U

d) R

e) The one who sits second to the left of W

Direction (106-110): Study the following statements and then decide which of the given conclusions logically follows from the given statements disregarding commonly known facts.

106. Statements:

Only a few metallic are paint.

No paint is vanish.

All vanish is acrylic.

Some acrylics are primer.

Conclusions:

I. Some metallic are not vanish.

II. No primer is paint.

III. Some vanish is primer.

- a) Only I follows
- b) Both I and II follow
- c) Both I and III follow
- d) Only III follows
- e) None follows

107. Statements:

All perfumes are shampoos.

Some shampoos are soaps.

Only a few soaps are powder.

No powder is detergent.

Conclusions:

I. Some soaps are detergent.

II. No perfume is powder.

IDBI Executive Previous Year Paper – English Version

III. All soaps are shampoo.

- a) Only I follows
- b) Only II follows
- c) Both I and III follow
- d) Both II and III follow
- e) None follows

108. Statements:

Some electricians are dynamic.

No dynamic is signal.

Only a few signals are waved.

All waved are magnetic.

Conclusions:

- I. No electrician is magnetic.
 - II. Some magnetic are signal.
 - III. Some waved are not dynamic.
- a) Only II follows
 - b) Only III follows
 - c) Both I and II follow
 - d) Both II and III follow
 - e) All follow

109. Statements:

All peaks are Everest.

No ice is Everest.

Only a few ices are stone.

All stones are mount.

Conclusions:

- I. Some peaks being ice is a possibility.
- II. All ices can be mount.

III. No Everest being stone is a possibility.

- a) Only II follows
- b) Both I and II follow
- c) Both II and III follow
- d) All follow
- e) None follows

110. Statements:

Only a few springs are rainy.

All rainy is autumn.

Some autumn is summer.

All summer is mist.

Conclusions:

- I. Some mists are autumn.
 - II. No rainy is summer.
 - III. All autumn is spring.
- a) Only I follows
 - b) Both I and III follow
 - c) Both II and III follow
 - d) All follow
 - e) None follows

Directions (111-113): Answer the questions based on the information given below.

Seven persons viz. A, B, C, D, E, F and G are of different weight, but not necessarily in the same order. The weight of G is less than only three persons. The weight of C is more than A but less than E whereas the weight of F is less than D but more than B. E is not the heaviest person while B

IDBI Executive Previous Year Paper – English Version

is heavier than G. The weight of the second heaviest person is 45kg and the weight of the second lightest person is 28kg.

111. If the weight of G is equal to the average weight of C and F, then what will be the weight of B?

- a) 39kg
- b) 46kg
- c) 33kg
- d) 27kg
- e) 35kg

112. Who among the following person is the heaviest?

- a) G
- b) F
- c) D
- d) E
- e) None of these

113. The number of persons heavier than C is one more than the number of persons lighter than _____.

- a) A
- b) B
- c) G
- d) E
- e) None of these

114. If in the number “219846357” all the digits are arranged in the increasing order from left to right, then how many digits remain unchanged in their position?

- a) One
- b) Two
- c) Three
- d) More than three
- e) None

115. If in the word “ERGONOMIC”, from the left end the odd positioned letters are replaced with the next letter and the even positioned letters are replaced with the previous letter in the English alphabetical series, then which of the following letter is second to the left of the third letter from the right end?

- a) P
- b) N
- c) O
- d) M
- e) None of these

116. How many such pairs of letters are there in the word “DISCOVERED” which have as many letters between them as in the English alphabetical series (both forward and backward direction)?

- a) One
- b) Two

IDBI Executive Previous Year Paper – English Version

- c) Three
- d) More than three
- e) None

Direction (117-121): Study the following information carefully and answer the question given below:

Eight persons P, Q, R, S, T, U, V and W went to the gym on two different dates either 11th or 22nd of four different months - March, April, May and June. Only one person went on each date but not necessarily in the given order.

W went on an odd numbered date of the month having 30 days. Only one person went between W and P. V went immediately before U but both went in different months. Two persons went between U and R. R did not go after P. The number of persons went between S and R is same as between P and T. T went one of the months after S.

117) _____ went on 22nd June.

- a) U
- b) T
- c) R
- d) Q
- e) None of these

118) How many persons went to the gym after S?

- a) Four
- b) Six
- c) Five
- d) Seven

- e) Three

119) Find the odd one out?

- a) The person went to the gym immediately after W
- b) U
- c) W
- d) The person went to the gym on June 22
- e) Q

120) _____ went to the gym two persons before U.

- a) P
- b) V
- c) T
- d) R
- e) W

121) Which of the following person did not go after Q?

- a) R
- b) S
- c) V
- d) T
- e) None of these

Directions (122-126): In each of the following questions, the relationship between different elements is shown in the statements followed by two conclusions. Find the conclusion which is definitely true.

122) Statements:

$L < V \leq M$; $G > X = Q \geq M$; $L > W$

Conclusions:

I. $G < L$

II. $X \geq V$

- a) If only conclusion I is true.
- b) If only conclusion II is true.
- c) If either conclusion I or II is true.
- d) If neither conclusion I nor II is true.
- e) If both conclusions I and II are true.

123) Statements:

$H > V < A < J$; $B > R \geq Q = J$; $B < F = X$

Conclusions:

I. $F > A$

II. $H < Q$

- a) If only conclusion I is true.
- b) If only conclusion II is true.
- c) If either conclusion I or II is true.
- d) If neither conclusion I nor II is true.
- e) If both conclusions I and II are true.

124. Statements:

$R < K = J$; $M \geq P \leq R$; $P > O \leq Q$

Conclusions:

I. $O < M$

II. $J \geq Q$

- a) Only I follow
- b) Only II follows
- c) Either I or II follows
- d) Neither I nor II follows
- e) Both I and II follow

125. Statements:

$A \geq F = D \leq G > O$; $P = G < R \leq W$

Conclusions:

I. $D < P$

II. $A \leq R$

- a) Only I follow
- b) Only II follows
- c) Either I or II follows
- d) Neither I nor II follows
- e) Both I and II follow

126. Statements:

$N \leq F \geq M = T$; $C > D = H < M = L$

Conclusions:

I. $L \leq C$

II. $F > D$

- a) Only I follow
- b) Only II follows
- c) Either I or II follows
- d) Neither I nor II follows
- e) Both I and II follow

Direction (127-129): Study the following information carefully and answer the questions given below.

Point P is 8m to the west of point Y and 5m to the south of point N. Point R is 6m to the west of point N. Point U is 7m to the north of point Y and 4m to the west of point G. Point G is 10m to the north of point K, which is 8m to the east of point S. Point S is 8m to the south of point V.

127. In which of the following direction is point U with respect to point V?

- a) Northeast
- b) Southwest
- c) Northwest
- d) Southeast
- e) None of these

128. What is the shortest distance between the points P and S?

- a) 6m
- b) 4m
- c) 5m
- d) 3m
- e) None of these

129. If point L is the midpoint of points G and K, then in which direction is point Y with respect to point L?

- a) Southeast
- b) Southwest
- c) Northeast
- d) West
- e) None of these

Directions (130-134): Study the following information carefully and answer the below questions.

Ten boxes- P, Q, R, S, T, U, V, W, X and Y are kept one above another on ten different shelves but not

necessarily in the same order. The lowermost shelf is numbered as one and the topmost shelf is numbered as ten.

Atmost two boxes are kept below box T. Box X is kept two boxes below box Y and kept immediately above box Q. Box Q is kept four boxes above box T. The number of boxes kept above box Y is the same as the number of boxes kept below box R. Box W is kept two boxes below box S which is kept adjacent to box Q. The number of boxes kept between X and S is the same as the number of boxes kept between V and P. Box P is kept below box Y.

130) How many boxes are kept between X and R?

- a) Four
- b) Three
- c) One
- d) Five
- e) Two

131) Which of the following box is kept immediately above box R?

- a) Box Y
- b) Box S
- c) Box P
- d) The box which is kept immediately below box W
- e) The box which is kept two boxes above box P

132) What is the position of box P from the top?

- a) Seventh

IDBI Executive Previous Year Paper – English Version

- b) Sixth
- c) Fifth
- d) Fourth
- e) Third

133) As many boxes kept above box X is the same as the number of boxes kept below box _____.

- a) Box W
- b) Box U
- c) Box T
- d) The box which is kept immediately below box V
- e) The box which is kept immediately above box S

134) Which of the following statement is true?

- a) Box S is kept immediately below box V
- b) Only two boxes are kept between P and S
- c) No boxes are kept between X and U
- d) More than three boxes are kept above U
- e) All the statement is true

Direction (135-137): Study the following information carefully and answer the questions given below.

G is the nephew of P, who is the only son of N. B is the sister-in-law of N, who doesn't have any siblings. V is the sister-in-law of D, who is the child of N. J is the mother-in-law of both V and M, who is the father of G. No single parent has a child.

135. Who among the following person is the mother of G?

- a) V

- b) J
- c) D
- d) B
- e) None of these

136. How is N related to V?

- a) Father
- b) Mother
- c) Mother-in-law
- d) Father-in-law
- e) None of these

137. If X is the spouse of B, then how is X related to D?

- a) Brother-in-law
- b) Uncle
- c) Son-in-law
- d) Aunty
- e) None of these

Directions (138-142): Study the following information carefully and answer the below questions

A certain number of persons are sitting in the linear row facing the north direction. Q sits fifth to the left of I. Only two persons are sitting between I and M. The number of persons sitting between Q and M is two less than the number of persons sitting between M and J. I and J are not immediate neighbours. L sits fourth to the right of J. X sits

IDBI Executive Previous Year Paper – English Version

eighth to the left of Q. T sits exactly in the middle of Q and X who sits on one of the ends. The number of persons sits to the left of T is the same as the persons to the right of L. P sits immediate right of V. V sits to the right of J. More than five persons sit between J and V.

138) How many persons sit between Q and J?

- a) 12
- b) 11
- c) 14
- d) 17
- e) 15

139) Who among the following persons sit between I and V?

- I) M
 - II) The one who sits fourth to the left of P
 - III) Q
- a) Only (I) and (II)
 - b) Only (I)
 - c) Only (I) and (III)
 - d) Only (III)
 - e) All (I), (II), and (III)

140) How many persons sit in the row?

- a) 32
- b) 35
- c) 33
- d) 31
- e) 36

141) What is the position of M from the extreme right end?

- a) Fourteenth
- b) Nineteenth
- c) Thirteenth
- d) Twelfth
- e) Eleventh

142) Who among the following person sits fifth from the left end?

- a) The one who sits sixth to the left of I
- b) Q
- c) T
- d) The one who sits tenth to the left of M
- e) J

Direction (143-146): Study the following information carefully and answer the questions given below.

In a certain code language,

'Different melody oxford moment' is coded as 'hd tr io ks'

'Oxford vaccine gain money' is coded as 'nj oh tr mn'

'Money from various gain' is coded as 'mn ug oh cy'

'Trail vaccine from outdated' is coded as 'sl nj ps ug'

143. What is the code for the phrase 'various money' in the given code language?

- a) cy oh
- b) mn cy
- c) oh mn
- d) Either a or b
- e) Either b or c

144. Which of the following word determines the code 'sl' in the given code language, if 'technology outdated' is written as 'ge ps'?

- a) From
- b) Vaccine
- c) Trial
- d) Various
- e) None of these

145. What is the code for the word 'melody' in the given code language, if 'beautiful moment' is written as 'ks en'?

- a) hd
- b) io
- c) tr
- d) Either b or c
- e) Cannot be determined

146. Which of the following phrase determines the code 'nj tr' in the given code language?

- a) Vaccine from
- b) Oxford vaccine

- c) Gain vaccine
- d) Money oxford
- e) None of these

147) Statements:

I. Lebanon's prime minister, Saad Hariri, has announced his resignation, in a move set to spark further uncertainty in a country paralysed by political dysfunction and nationwide protests.

II. The depth of the crisis and lack of political solutions have galvanized Lebanese citizens from all political persuasions and walks of life, leading to a movement that shows little sign of slowing down.

A. Statement I is the cause and statement II is its effect

B. Statement II is the cause and statement I is its effect

C. Both the statements I and II are independent causes

D. Both the statements I and II are effects of independent causes

E. Both the statements I and II are effects of some common cause

148) Statement: Chief Minister Y.S. Jagan Mohan Reddy inaugurated the Virtual Police Station at Andhra University.

Arguments:

I). The concept of Virtual police station will not be effective because there is no such concept successful so far.

II). A senior police officer said that students can use the facility to file their complaints which will be forwarded to police officials concerned after scrutiny by the control room.

A.If only argument I is strong

B.If only argument II is strong

C.If either I or II is strong

D.If neither I or II is strong

E.If both I and II are strong

149) Statements:

I. The Tamilnadu Mercantile Bank has been penalized for non-compliance with certain provisions of directions issued by RBI on fraud classification and reporting by commercial banks.

II. The Reserve Bank has imposed a penalty of Rs 35 lakhs on Tamilnadu Mercantile Bank for violating norms on fraud classification and notification.

A.Statement I is the cause and statement II is its effect

B.Statement II is the cause and statement I is its effect

C.Both the statements I and II are independent causes

D.Both the statements I and II are effects of independent causes

E.Both the statements I and II are effects of some common cause

150) Statement: Ministry of Coal to establish “Sustainable Development Cell” to promote clean mining.

Assumptions:

I). The Sustainable Development Cell envisages to address the environmental mitigation measures in a systemic manner and to provide a better environment to people working and residing in the vicinity of Mines.

II). Sustainable Development Cell will also formulate the future policy framework for the environmental mitigation measures including the Mine closure Fund.

A.If only assumption I is implicit

B.If only assumption II is implicit

C.If either I or II is implicit

D.If neither I or II is implicit

E.If both I and II are implicit

1) Answer: B

In the given passage, it is mentioned that “Gol has launched the National Monetisation Pipeline (NMP), which aims to monetise assets without transferring ownership.”

Therefore, option B is the correct answer.

2) Answer: E

In the given passage, it is mentioned that “The main model envisages a contract between Gol and a private entity to operate an asset for a specified period.”

The word envisage/anticipate is to predict something as a future possibility or expect something.

Therefore, option E is the correct answer.

3) Answer: C

In the given passage, it is mentioned that “To put it in context, it’s a little less than the Rs 6.45 lakh crore PSUs contributed towards capital expenditure in Gol’s budget for 2020-21. Perhaps, to mitigate political risks, NMP classifies land and buildings as non-core assets.”

Therefore, option C is the correct answer.

4) Answer: B

In the given passage, it is mentioned that “to mitigate political risks, NMP classifies land and buildings as non-core assets. That leaves mainly

roads, railways, airports and pipelines that are already built as the core assets that will be monetised. NMP resource mobilisation rests mainly on **roads (27%) and railways (25%)** to mop up resources.”

Therefore, option B is the correct answer.

5) Answer: D

In the given passage, it is mentioned that “Power Grid Corporation, for example, raised funds this year for earmarked projects through an **Infrastructure Investment Trust IPO.**”

Therefore, option D is the correct answer.

6) Answer: B

The error lies in part B in the wrong usage of the verb. The modal ‘may’ should be followed by the base form of the verb. So ‘come’ is the correct usage.

Therefore, the correct sentence is:

the quantum of private money that **may (A)/ come** in is influenced by the extent (B)/ to which infrastructure financing (C)/ is insulated from political risks. (D)/

7) Answer: A

The word ‘envisage’ means ‘to contemplate or conceive of as a possibility or a desirable future event’ and the word ‘forecast’ means ‘predict or estimate (a future event or trend).’

IDBI Executive Previous Year Paper – English Version

Therefore, option A is the correct answer.

8) Answer: D

The word 'mitigate' means 'to reduce' and the word 'aggravate' means 'make (a problem, injury, or offence) worse or more serious.'

Therefore, option D is the correct answer.

9) Answer: A

The highlighted part must be replaced with "off the hook" to make it a grammatically correct sentence.
Off the hook-let off from trouble / escape or released from a tough situation

10) Answer: B

The highlighted part must be replaced with "give her a hand" to make it a grammatically correct sentence.

Here to will be followed by V1 (to + v1)

11) Answer: C

The highlighted part must be replaced with "take justice into their own hands" to make it a grammatically correct sentence.

Correct phrase is take justice into their own hands which means punish someone or do something to put a situation right, instead of waiting for the police or the legal system to take action

12) Answer: D

The highlighted part must be replaced with "an urgent need to look for" to make it a grammatically correct sentence.

Look For: to hope to get something that you want or need.

13) Answer: A

The highlighted part must be replaced with "strike a balance between" to make it a grammatically correct sentence.

Strike a balance between – to give the correct amount of importance or attention to two separate things.

14) Answer: D

The context of the sentence talks about the wastage of chemical industry that will make the living conditions worse together at a point in time
Options (B) and (C) - Both 'trash and 'debris' may fill the first blank but 'hateful ' and 'stocking' are not contextually strong words to fill the second blank

'Trash' - waste material

'Debris' -scattered pieces of rubbish

Option (E) is out of context

'Besmirch' damage (someone's reputation).

Between (A) and (D) Both 'atrocious' and 'appalling' may fill the second blank but 'litter' is grammatical incorrect for the first blank, because we need a gerund here. So, 'littering ' will fill the first blank

IDBI Executive Previous Year Paper – English Version

'Litter' - rubbish such as paper, cans and bottles left lying in an open or public place

'Atrocious' - causing shock or dismay; horrific

15) Answer: B

The Context of the sentence is that a person may get infected even after the vaccination and may remain passive spreader of the infection

Options (a) and (C) - Both 'Transmuted' and 'mutated' may fill the first blank, but both 'Transmission' and 'symptomatic' do not fit the context of the second blank

'Transmuted' - Change in form of nature or substance

'Mutated' change in form or nature

'Symptomatic' - serving as a symptom or a sign

Options (D) and (E) - Both 'Improved' and 'advanced' don't support the context of the sentence, although 'asymptomatic' fits in the second blank, 'Indicative' does not support the context

'Asymptomatic' (of a condition or a person) producing or showing no symptoms

Option (B) both the words fit the blank contextually and grammatically

'Breakthrough' a sudden dramatic and important discovery

16) Answer: C

The context of the sentence is that the act of covering the face not only made us unusual faceless morons but also something which is between the life and death

Options (A) and (E) - Both 'guide' and 'take' fill the first blank but 'version' and 'illustration' don't support the context of the sentence. Although 'emblem' may fill the second blank but 'figurine' is not a contextually strong word

'Shun' - to avoid or refuse to accept someone or something

'Dodge' - avoid (someone or something) by a sudden quick movement

'Emblem' - a symbolic object as a distinctive badge of a nation, organization or family

'Figurine' - a statuette especially one of a human form

Option (C) - Both 'ushered' and 'totem' fill the respective blanks

'Ushered' - show or guide (someone) somewhere

'Totem' - a person or thing regarded as being symbolic or representative of a particular quality or concept

17) Answer: A

The context of the sentence is about the right to dream to be distant from all nightmares must remain a struggle, especially justified by bigoted and corrupt corporate

IDBI Executive Previous Year Paper – English Version

Options (B) and (D) Both 'latently' and 'passively' do support the context of the first blank and though 'unprincipled' may fill the second blank, 'prudent' doesn't fit into the context

'Latently' - (of a quality or state) existing but not yet developed or manifested; hidden or concealed

Prudent - acting or showing care and thought for the future

Passively - in an accepting manner, without active response or resistance

'Unprincipled' - (of a person or their behaviour or acting in accordance with moral principles

Options (C) and (E) - Both 'attentively' and 'sedulously' fit into the context of the first blank but 'frugal' and 'upright' are out of context

'Sedulously' - (of a person or action) showing dedication and diligence

'Frugal' - simple and plain and costing little

'Upright' - strictly honorable or honest

Option (A) Both 'assiduously' and 'profligate' fit into the context of the respective blanks

'Assiduously' - showing great care and perseverance; diligent

'Profligate' recklessly extravagant or wasteful in the use of resources; immoral

18) Answer: D

The context of the sentence is about the rising race related differences in the USA, which makes the

corporate lives of Blacks and ethnic minorities unfavorable

Options (A) and (C) - Both 'Disfavour' and 'Confound' are out of context, 'Deceptive' and 'deceitful' may fill the second blank but we have better option than this

'Deceptive' - giving an appearance or impression different from the true one; misleading

'Confound' - cause surprise or confusion in (someone); especially by not according with their expectations.

'Deceitful' - Guilty of or involving deceit; misleading, dishonest

Options (B) and (E) - Both 'Secern' and 'demarcation' 'the action of fixing the boundary or limits of something

'Mendacious' - not telling the truth; lying

'Straightforward' - uncomplicated and easy to do or understand

Option (D) - Both 'Discriminate' and 'insidious' support the context of the respective blanks

'Discrimination' - the treatment of a person or particular group of people differently

'Insidious' - proceeding in a gradual, subtle way, but with very harmful effects

19) Answer: D

(A) Economic is used instead of economical
Economical means cheap and it does not create any sense with the sentence.

The 2020-21 Index drops several **economic** indicators and gives greater weightage to social equality indicators such as representation of women and people from marginalized communities in legislatures and local governance institutions, and crimes against SC/ST communities.

20) Answer: E

21) Answer: A

The sentence is in past tense, so had is used instead of has

In 2013, the Reserve Bank of India **had** first issued a press release cautioning users and investors of virtual currencies, and indicated that they were reviewing the legality of such assets under the prevailing regulatory frameworks.

22) Answer: B

(B) One of the _____ + singular verb is used

Is is used instead of are

(C) Illegal is used instead of legal, the examples are given are of illegal activities.

One of the reasons as to why India perhaps has been leaning towards banning cryptocurrencies is the possibility of the cryptocurrencies being used for financing **illegal** activities such as funding terror, money laundering, tax evasion, etc.

23) Answer: A

(A) Omit the before Prime Minister Narendra Modi
(D) Its is used instead of their, its is used for scheme

Delhi Chief Minister Arvind Kejriwal on Sunday asked Prime Minister Narendra Modi why the doorstep ration delivery scheme by his government was stalled by the Centre and appealed to him to allow **its** implementation in the national interest.

24) Answer: B

From the Context we can understand that some kind of physical action is being taken to get vaccinated. Among the options only 'intimidation' and "Compelling" are supporting the context between these two 'intimidations' shows the intensity of the actions that are being taken to get vaccinated.

Meaning of "Intimidation" – to make timid or fearful:
frighten

"Menace" – be a threat or possible danger to

"Emboldening" – give (someone) the courage or confidence to do something.

"Compelling" - Evoking interest, attention or admiration in a powerfully irresistible way

"Solace" – give comfort or consolation to

25) Answer: D

From the context we can understand that some tactics are reported in China which include harassment and spying. We can sense that a negative word will come in the blank. Among the options, only 'Coercive' supports the context of the sentence.

Meaning of “Coercive”- relating to or using force or threats

“Demanding”- (of a task) requiring much skill or effort

“Discretionary”- the quality of behaving or speaking in such a way as to avoid causing offence or revealing confidential information

“Obligatory” – required by a legal, moral or other rule; compulsory

“Peremptory” – leaving no opportunity for denial or refusal

26) Answer: A

From the context we can understand that, even in the absence of physical actions, if some penalties are imposed it will give an opposite result. Among the options only 'Counterproductive' supports the context

Meaning of “Counterproductive” – having the opposite of the desired effect

“Counter instance”- a case that contradicts a rule, theory etc.

“Counterforce” – a force that acts in opposition to another force

“Counter violence” – violence committed in retaliation for violence

“Counterplotting” – a plot designed to thwart an opponent’s plot

27) Answer: D

We can understand that careful and judicious use will provide more benefits rather than harms. Among the options only 'outweigh' supports the context

Meaning of “Outweigh” – be heavier, greater or significant than

“Redress”- remedy or set right (an undesirable or unfair situation)

“Outbalance” – be more valuable, importance or influential than

“Succumb” – fail to resist pressure, temptation or some other negative force

“Dwarf” – denoting something, that is much smaller than the usual size for its type or species

28) Answer: E

From the context we can understand that whether the careful or judicious method is satisfactory for doubters is yet to be seen. Among the options, only 'Skeptics' justifies the context.

Meaning of “Skeptics”- a person inclined to question or doubt accepted opinions

“Agnostics” – a person who believes that nothing is known or can be known of the existence or nature of God

“Misanthropists” – a person who dislikes humankind and avoids human society

“Scoffers” – a person who mocks or makes fun of someone or something

29) Answer: C

BF: India said on Thursday it expects Pakistan to allow a visit this month by a group of 1,500 pilgrims on the occasion of Gurupurab or birth anniversary of Guru Nanak, following the denial of permission for visits by two other groups earlier this year.

CE: Land travel between India and Pakistan is since being conducted on a limited scale through the Attari-Wagah integrated check post in coordination with the Pakistani side.

30) Answer: E

AD: Amritsar Farmers residing in the border areas of Punjab, under the banner of Border Area Sangharash Committee (BASC), protested outside the Border Security Force (BSF)'s Khasa headquarters in Amritsar on Thursday against the extension of the force's jurisdiction.

CF: The Centre should focus on the 15-km jurisdiction to curb the smuggling bid from across the border and release compensation of the border farmers.

There's an error in part E. We should use 'nearly' instead of 'near'.

31) Answer: E

AF: Nykaa founder Falguni Nayar became India's seventh woman billionaire and the wealthiest self-made billionaire in an ongoing IPO boom which saw the e-commerce giant making a blockbuster debut on Dalal Street.

BE: The UPI AutoPay facility has seen widescale adoption by consumers as the norms for standing instructions for recurring payments of the Reserve Bank of India kicked in from October 1.

CD: The Drugs Controller General of India is reviewing the clinical data of molnupiravir, the world's first anti-Covid pill approved in the United Kingdom, for the treatment of Covid-19 in adults in India.

32) Answer: B

BD: To strengthen data privacy, the government has introduced the Personal Data Protection Bill, 2019, which is under consideration of the Joint Parliamentary Committee.

CE: Waste generation is an acute problem, arising from the lack of proper waste management/processing systems.

Hand wringing – the excessive display of concern or distress

33) Answer: B

The correct sequence of the given sentence is **CABD**. The sentence after rearrangement is, Future education requires students to partner with international peers across cultures on the internet and in virtual classrooms.

Hence, option (b) is the right answer choice.

34) Answer: A

The correct sequence of the given sentence is **BDCA**. The sentence after rearrangement is, Gender and sanitation means going beyond the instrumental objectives of meeting programme objectives, and beyond the inclusion of women as beneficiaries.

Hence, option (a) is the right answer choice.

35) Answer: D

The correct sequence of the given sentence is **BCDA**. The sentence after rearrangement is, The guidelines were an unhappy blend of power and passion trying to supersede the lack of attributes explained by misguided enthusiasm and wasted energy.

Hence, option (d) is the right answer choice.

36) Answer: C

The correct sequence of the given sentence is **CDBA**. The sentence after rearrangement is,

India is the second most targeted country for ransomware after the US and so the government is reportedly working closely with multinational cybersecurity firms to issue timely alerts on ransomware.

Hence, option (c) is the right answer choice.

37) Answer: B

The correct sequence of the given sentence is **BACD**. The sentence after rearrangement is, The banks are reluctant to lend to large entities because of the accumulation of stressed assets over the past five years independent of the pandemic.

Hence, option (b) is the right answer choice.

38) Answer: B

The correct sequence is QPTSR.

First, we need to find the first sentence. Apart from Sentence Q, all other options contain a transition. Thus, Q is our first sentence. The sentence is in present tense also. It says that an application of Boeing has been approved.

After it, if we look at sentences P, T and S; all are in past tense and show what had happened earlier. P will be placed first because of the word "earlier". After it, we will place sentence T because it contains the transition "at that time" i.e. a reference to the word "earlier" in P. Finally, we have S because of the reason for P and T i.e. why the

application hadn't been approved earlier clearly evident by the phrase "It was because of the fact". Last but not the least, the contrast is shown by the Sentence R and it also mentions that the approval has been given now. It will thus be placed at last.

39) Answer: D

The correct sequence is QPTRS.

First, we need to find the first sentence. Apart from Sentence Q, all other options contain a transition. Thus, Q is our first sentence. The sentence is in present tense also. It says that an application of Boeing has been approved.

After it, if we look at sentences P, T and S; all are in past tense and show what had happened earlier. P will be placed first because of the word "earlier". After it, we will place sentence T because it contains the transition "at that time" i.e. a reference to the word "earlier" in P. Finally, we have S because of the reason for P and T i.e. why the application hadn't been approved earlier clearly evident by the phrase "It was because of the fact". Last but not the least, the contrast is shown by the Sentence R and it also mentions that the approval has been given now. It will thus be placed at last.

40) Answer: B

The correct sequence is QPTRS.

First, we need to find the first sentence. Apart from Sentence Q, all other options contain a transition.

Thus, Q is our first sentence. The sentence is in present tense also. It says that an application of Boeing has been approved.

After it, if we look at sentences P, T and S; all are in past tense and show what had happened earlier. P will be placed first because of the word "earlier". After it, we will place sentence T because it contains the transition "at that time" i.e. a reference to the word "earlier" in P. Finally, we have S because of the reason for P and T i.e. why the application hadn't been approved earlier clearly evident by the phrase "It was because of the fact". Last but not the least, the contrast is shown by the Sentence R and it also mentions that the approval has been given now. It will thus be placed at last.

41) Answer: D

The correct sequence is QPTRS.

First, we need to find the first sentence. Apart from Sentence Q, all other options contain a transition. Thus, Q is our first sentence. The sentence is in present tense also. It says that an application of Boeing has been approved.

After it, if we look at sentences P, T and S; all are in past tense and show what had happened earlier. P will be placed first because of the word "earlier". After it, we will place sentence T because it contains the transition "at that time" i.e. a reference to the word "earlier" in P. Finally, we have S because of the reason for P and T i.e. why the

IDBI Executive Previous Year Paper – English Version

application hadn't been approved earlier clearly evident by the phrase "It was because of the fact". Last but not the least, the contrast is shown by the Sentence R and it also mentions that the approval has been given now. It will thus be placed at last.

42) Answer: D

The correct sequence is QPTSR.

First, we need to find the first sentence. Apart from Sentence Q, all other options contain a transition. Thus, Q is our first sentence. The sentence is in present tense also. It says that an application of Boeing has been approved.

After it, if we look at sentences P, T and S; all are in past tense and show what had happened earlier. P will be placed first because of the word "earlier". After it, we will place sentence T because it contains the transition "at that time" i.e. a reference to the word "earlier" in P. Finally, we have S because of the reason for P and T i.e. why the application hadn't been approved earlier clearly evident by the phrase "It was because of the fact". Last but not the least, the contrast is shown by the Sentence R and it also mentions that the approval has been given now. It will thus be placed at last.

43) Answer: B

"Deficient" is grammatically wrong here.

Options (A), (C) and (D) talk opposite to the context of the sentence.

"Copious" means large in quantity or number

"Abundant" means existing or available in large quantities; plentiful

Option (B) is both grammatically and contextually fill the blank.

44) Answer: D

'Persuasion' is contextually wrong. It means the action or process of persuading someone or of being persuaded to have a believe in something Options (A) (B) and (C) all do not fit to the context of the sentence.

'Tenet' means a principle or belief

'Dogma' means a principle or set of principles laid down by an authority as incontrovertibly true.

'Misgiving' means a feeling of doubt or apprehension about the outcome or consequences of something

'Conviction' means a formal declaration by the verdict of a jury or the decision of a judge in a court of law that someone is guilty of a criminal offence.

45) Answer: C

'Clearing' does not support the context of the sentence.

Option (A), (B) and (D) talks opposite to the context of the sentence.

'Incrimination' means to be charged with the involvement in a crime where he/ she was incriminated in the conspiracy.

IDBI Executive Previous Year Paper – English Version

'Impeachment' means the action of calling into question the integrity or validity of something.

'Accusation' means a charge or claim of something that has done something illegal or wrong.

Option (C) 'Acquittal' supports the context of the sentence.

'Acquittal' means a judgment or verdict that a person is not guilty of the crime with which they have been charged.

46) Answer: A

'Albatross' is out of context. Albatross is a very large, chiefly white oceanic bird with long narrow wings. Found mainly in the southern oceans.

Options (B), (C) and (D) do not support the context of the sentence

'Stigma' means a mark of disgrace associated with a particular circumstance, quality or person.

Option (A) 'Onus' contextually and grammatically fit the blank. 'Onus' means something that is one's duty or responsibility.

47) Answer: E

'Rigorous' means harsh and demanding conditions; Hardship

All other options do support the context of the sentence but are grammatically incorrect. We need nouns to fill the blank but in options all are adjectives.

48) Answer: A

(A) **Despite:** - without being affected by the thing mentioned

(B) **Furthermore:** - also; in addition

(C) **As:** - while something else is happening

(D) **Because:** - for the reason that

Private hospitals have been vaccinating thousands of beneficiaries in Pune, government sites have been vaccinating fewer numbers **despite** having more vaccination centers open.

49) Answer: B

(A) **Whereas:** -used for showing a fact that is different

(B) **Wherein:** -in which place, situation or thing; in what way

(C) **Whoever:** -the person or people who; any person who

(D) **Nevertheless:** -in spite of that

A division bench comprising Justice Ravi Malimath and Justice Jyotsna Rewal Dua passed these orders on public interest litigation, **wherein** the petitioner has alleged that the toll plaza at Sanwara is illegal.

50) Answer: A

(A) **As:** -while something else is happening, used for comparing people or things

(B) **In spite of:** -without being affected by the thing mentioned

IDBI Executive Previous Year Paper – English Version

(C) So: -used to emphasize an adjective or adverb, especially when this produces a particular result

(D) Because: -for the reason that

Indian shares ended at a record high on Monday, buoyed by hopes that the economy would return to normal **as** some states eased lockdowns, with daily Covid-19 cases hitting a two-month low.

Direction (51-55):

Total number of bikes manufactured in January= $240 \times 2 = 480$

Number of Yamaha bikes manufactured in January=320

Number of Honda bikes manufactured in January=160

Total number of bikes manufactured in February= $300 \times 2 = 600$

Number of Yamaha bikes manufactured in February=360

Number of Honda bikes manufactured in February=240

Total number of bikes manufactured in March= $180 \times 2 = 360$

Number of Yamaha bikes manufactured in March=220

Number of Honda bikes manufactured in March=140

Total number of bikes manufactured in April= $360 \times 2 = 720$

Number of Yamaha bikes manufactured in April=420

Number of Honda bikes manufactured in April=300

Total number of bikes manufactured in May= $280 \times 2 = 560$

Number of Yamaha bikes manufactured in May=320

Number of Honda bikes manufactured in May=240

Month	Total number of bikes manufactured	Number of Yamaha bikes manufactured	Number of Honda bikes manufactured
January	480	320	160
February	600	360	240
March	360	220	140
April	720	420	300
May	560	320	240

51) Answer: C

IDBI Executive Previous Year Paper – English Version

Total number of bikes manufactured in June = $160 \times 3 = 480$

Number of Yamaha bikes manufactured in June = $320 \times 75 / 100 = 240$

Number of Honda bikes manufactured in June = $480 - 240 = 240$

52) Answer: A

Required difference = $220 + 320 - 240 - 140 = 160$

53) Answer: D

Number of Yamaha bikes in April are unsold = $420 \times 2 / 7 = 120$

Total number of bikes in April are unsold = $720 \times 25 / 100 = 180$

Number of Honda bikes in April are unsold = $180 - 120 = 60$

54) Answer: B

Number of Honda bikes manufactured in February and April = $240 + 300 = 540$

Required ratio = $540 : 360 = 3 : 2$

55) Answer: D

Required answer = 60% of $(360 + 420 + 320) = 60 \times 1100 / 100 = 660$

56) Answer: D

$711.93 \div \sqrt{65} + 19.91\% \text{ of } 199.89 = ? + \sqrt{840}$

$89 + 40 = ? + 29$

$? = 100$

57) Answer: B

$? \% \text{ of } 3499 = 1684.02 - 487.998 - 31.32\% \text{ of } 1600.32$

$? \% \text{ of } 3500 = 1684 - 488 - 31\% \text{ of } 1600$

$? \times 35 = 1684 - 488 - 496$

$= 20$

58) Answer: D

$? \times 23.02 = 24.34 \times 45.01 + 820 - 59.89\% \text{ of } 2400.4$

$? \times 23 = 24 \times 45 + 820 - 60\% \text{ of } 2400$

$? \times 23 = 1080 + 820 - 1440$

$? = 460 / 23$

$= 20$

59) Answer: C

$?^2 = 210\% \text{ of } 799 + (37.99)^2 + 108 \times 9.03$

$?^2 = 210\% \text{ of } 800 + (38)^2 + 108 \times 9$

$?^2 = 210 \times 8 + 1444 + 972$

$?^2 = 1680 + 1444 + 972$

$?^2 = 4096$

$64^2 = 4096$

60) Answer: E

$31.11 \times 5.98 + 1170.12 \div \sqrt{1520} - 1199.98 \div 15.15 = ?$

$186 + 30 - 80 = ?$

$? = 136$

61) Answer: C

IDBI Executive Previous Year Paper – English Version

$$17.5 \% \text{ of } 319.912 - 39.98 \% \text{ of } \sqrt{4220} = ?$$

$$56 - 26 = ?$$

$$? = 30$$

62) Answer: B

$$24.89\% \text{ of } 432.21 * 24.96 = ?$$

$$25\% \text{ of } 432 * 25 = ?$$

$$25/100 * 432 * 25 = 2700$$

63) Answer: C

$$25.25 \% \text{ of } 320.19 + 111.98 - \sqrt{3135} = ?$$

$$80 + 112 - 56 = ?$$

$$136 = ?$$

64) Answer: C

$$\sqrt{65} * (1015.18 \div 28.91) = ? * 7.12$$

$$8 * 35 = ? * 7$$

$$? = 40$$

65) Answer: A

$$12.981 * \sqrt{575} * 4.99 - 4480.12 \div \sqrt{63} = ?^3$$

$$1560 - 560 = ?^3$$

$$? = 10$$

Direction (66-70):

Total number of students who appeared for common eligibility test=2500

Total number of students who appeared for TNEB=2500*22/100=550

Total number of students who appeared for SSC=2500*18/100=450

Total number of students who appeared for RRB=2500*20/100=500

Total number of students who appeared for TNPSC=2500*16/100=400

Total number of students who appeared for JEE=2500*24/100=600

66) Answer: D

Total number of students who applied for JEE exam=600*100/75=800

Number of boys who applied for JEE exam=500

67) Answer: A

Total number of students who appeared for the SSC exam in 2021=450*7/5=630

Required percentage=(630-500)/500*100=130/5=26%

68) Answer: B

Required difference=450+400-600=250

69) Answer: C

Total number of students who appeared for TNPSC and JEE=400+600=1000

Required percentage=(1000-550)/1000*100=45%

70) Answer: D

Total number of students who appeared for NTPC exam=550*80/100=440

IDBI Executive Previous Year Paper – English Version

Number of girls who appeared for NTPC exam = $440 \times 25/100 = 110$

71) Answer: C

$$x^2 - 21x + 104 = 0$$

$$x^2 - 13x - 8x + 104 = 0$$

$$x(x - 13) - 8(x - 13) = 0$$

$$x = 8, 13$$

$$y^2 - 19y + 84 = 0$$

$$y^2 - 12y - 7y + 84 = 0$$

$$y(y - 12) - 7(y - 12) = 0$$

$$y = 12, 7$$

Relationship between x and y cannot be established.

72) Answer: C

$$x^2 + 10x - 231 = 0$$

$$x^2 + 21x - 11x - 231 = 0$$

$$x(x + 21) - 11(x + 21) = 0$$

$$x = -21, +11$$

$$y^2 - 6y - 216 = 0$$

$$y^2 - 18y + 12y - 216 = 0$$

$$y(y - 18) + 12(y - 18) = 0$$

$$y = +18, -12$$

Relationship can't be determined

73) Answer: C

$$4x^2 - 25x + 36 = 0$$

$$4x^2 - 16x - 9x + 36 = 0$$

$$4x(x - 4) - 9(x - 4) = 0$$

$$x = +4, +9/4$$

$$x = +4, +2.25$$

$$y^2 + 476 = 512$$

$$y^2 = 36$$

$$y = \pm 6$$

Relationship can't be determined

74) Answer: A

$$x^2 - 40x + 384 = 0$$

$$x^2 - 24x - 16x + 384 = 0$$

$$x(x - 24) - 16(x - 24) = 0$$

$$x = 24, 16$$

$$y^2 - 26y = -168$$

$$y^2 - 14y - 12y + 168 = 0$$

$$y(y - 14) - 12(y - 14) = 0$$

$$y = 14, 12$$

$$x > y$$

75) Answer: E

$$x^2 + 7x + 12 = 0$$

$$x^2 + 3x + 4x + 12 = 0$$

$$x(x + 3) + 4(x + 3) = 0$$

$$x = -3, -4$$

$$y^2 - 2y - 15 = 0$$

$$y^2 - 5y + 3y - 15 = 0$$

$$y(y - 5) + 3(y - 5) = 0$$

$$y = 5, -3$$

$$x \leq y$$

Direction (76-80):

IDBI Executive Previous Year Paper – English Version

Number of boys who are learning dance in institute

$$A = 480 \times \frac{7}{12} = 280$$

Number of girls who are learning dance in institute

$$A = 480 - 280 = 200$$

Number of boys who are learning dance in institute

$$B = 540 \times \frac{5}{9} = 300$$

Number of girls who are learning dance in institute

$$B = 540 - 300 = 240$$

Number of boys who are learning dance in institute

$$C = 630 \times \frac{1}{3} = 210$$

Number of girls who are learning dance in institute

$$C = 630 - 210 = 420$$

Number of boys who are learning dance in institute

$$D = 340 \times \frac{7}{10} = 238$$

Number of girls who are learning dance in institute

$$D = 340 - 238 = 102$$

Number of boys who are learning dance in institute

$$E = 750 \times \frac{4}{15} = 200$$

Number of girls who are learning dance in institute

$$E = 750 - 200 = 550$$

Institute	Number of boys who are learning dance	Number of girls who are learning dance
A	280	200
B	300	240
C	210	420
D	238	102
E	200	550

76) Answer: C

Total number of students who are learning music in institute $A = 480 \times \frac{40}{60} = 320$

Number of boys who are learning music in institute

$$A = 280 \times \frac{5}{7} = 200$$

Number of girls who are learning music in institute

$$A = 320 - 200 = 120$$

77) Answer: A

Required difference = $280 + 200 - 420 = 60$ more

78) Answer: B

Number of girls who are learning dance in institute

$$F = 550 \times \frac{60}{100} = 330$$

Number of boys who are learning dance in institute

$$F = 330 \times \frac{45}{55} = 270$$

Required difference = $270 - 200 = 70$

79) Answer: D

IDBI Executive Previous Year Paper – English Version

Number of girls who are learning dance in institutes

$$A \text{ and } E = 200 + 550 = 750$$

$$\text{Required ratio} = 750 : 300 = 5 : 2$$

80) Answer: C

Number of boys who are learning dance in institutes B and E = $300 + 200 = 500$

$$\text{Required percentage} = \frac{420 - 500}{500} * 100 = \frac{80}{5} = 16\%$$

81) Answer: A

$$24 * 0.5 = 12$$

$$12 * 1 = 12$$

$$12 * 1.5 = 18$$

$$18 * 2 = 36$$

$$36 * 2.5 = 90$$

82) Answer: E

$$1 + 6^2 = 37$$

$$37 + 8^2 = 101$$

$$101 + 6^2 = 137$$

$$137 + 8^2 = 201$$

$$201 + 6^2 = 237$$

83) Answer: C

$$27 + (3 * 2) = 33$$

$$33 + (5 * 4) = 53$$

$$53 + (7 * 6) = 95$$

$$95 + (9 * 8) = 167$$

$$167 + (11 * 10) = 277$$

84) Answer: C

$$1 + 12 = 13$$

$$13 + 24 = 37$$

$$37 + 36 = 73$$

$$73 + 48 = 121$$

$$121 + 60 = 181$$

85) Answer: B

$$7 + 95 = 102$$

$$102 + 85 = 187$$

$$187 + 75 = 262$$

$$262 + 65 = 327$$

$$327 + 55 = 382$$

86) Answer: A

$$5x * \frac{90}{100} - 240 = 3x + 960$$

$$4.5x - 3x = 1200$$

$$x = 800$$

$$\text{MP of cooker} = 5 * 800 = \text{Rs.}4000$$

87) Answer: B

$$\begin{aligned} \text{Rate of interest} &= \frac{(10950.3 - 9522)}{9522} * 100 \\ &= 15\% \end{aligned}$$

$$9522 = P * (1 + \frac{15}{100})^2$$

$$P = 7200$$

88) Answer: A

The total number of students in schools A and B = 750

IDBI Executive Previous Year Paper – English Version

The total number of students in school A = $750 - 200 \times 2 = 750 - 400 = 350$

The number of girls in school A = $350 \times \frac{3}{7} = 150$

89) Answer: D

Total number of pens = $4 + 7 + 5 = 16$

Required

probability = $\frac{{}^7C_3 \times {}^{16}C_3}{{}^{23}C_6} = \frac{12 \times 11 \times 10}{(16 \times 15 \times 14)}$
 $= \frac{11}{28}$

90) Answer: A

Anbu + Ezhil + 14 = 37×2

Anbu + Ezhil = 60

$3x + 2x = 60 - 10$

$5x = 50$

$x = 10$

Present age of Ezhil = $60 - (2 \times 10 + 5) = 35$

Tamil = $\frac{9}{7} \times 35 = 45$

Required ratio = $(2 \times 10 + 5 + 10) : 45 + 10$

$= 35 : 55$

$= 7 : 11$

91) Answer: C

Profit ratio of A, B and C = $3600 \times 4 : 1320 \times 12 : 5100 \times 8$

$= 300 : 330 : 850$

$= 30 : 33 : 85$

Profit share of

A = $\frac{7400 \times 30}{(30 + 33 + 85)} = \frac{7400 \times 30}{148} = \text{Rs. } 1500$

92) Answer: B

Distance = $45 \times \frac{t}{60} = \frac{3t}{4}$

Distance = $54 \times \frac{(t - 40)}{60} = \frac{9}{10} \times (t - 40)$

$\frac{3t}{4} = \frac{9t}{10} - 36$

$36 = \frac{6t}{40}$

$t = 240$ minutes

Distance = $3 \times \frac{240}{4} = 180$ km

93) Answer: B

Time taken by C alone complete the work = $\frac{1}{(\frac{1}{9} - \frac{1}{12})}$

$= \frac{1}{[\frac{(4-3)}{36}]}$

$= 36$ days

B is 20% more efficient than that of C = $\frac{36 \times 100}{120} = 30$ days

Time taken by A alone complete the work = $\frac{1}{(\frac{1}{12} - \frac{1}{30})}$

$= \frac{1}{[\frac{(5-2)}{60}]}$

$= \frac{60}{3}$

$= 20$ days

94) Answer: D

Let the CP = x

And the MP = $x + 9600$

$(x + 9600) \times \frac{75}{100} - x = x \times \frac{5}{100}$

$\frac{3x}{4} + 7200 - x = \frac{x}{20}$

$\frac{x}{20} + \frac{x}{4} = 7200$

$6x = 144000$

$x = 24000$

Cost price of the fridge = Rs. 24000

95) Answer: B

Pipe C alone fill the tank = 16 hours

IDBI Executive Previous Year Paper – English Version

Pipe B alone fill the tank= $16\frac{3}{4}=12$ hours

$$A+B=1/8$$

$$A+1/12=1/8$$

$$A=1/24$$

Total quantity of the tank=48 units

Efficiency of pipe A= $48/24=2$ units/day

Pipes A, B and C together fill the tank in 4 hours= $4*(1/24+1/12+1/16)$

$$=4*9/48=36/48$$

Remaining tank= $1-36/48=12/48$

Required time= $12/2=6$ days

96) Answer: A

Let the quantity of milk in the initial mixture= $11x$

And the quantity of water in the initial mixture= $4x$

$$(11x-30*11/15)/(4x-30*4/15+33)=2/1$$

$$(11x-22)=(4x+25)*2$$

$$11x-22=8x+50$$

$$x=24$$

Required initial quantity= $(11+4)*24=360$ liters

97) Answer: A

Speed of the stream= 12 kmph

Upstream speed of the boat A= $192/12=16$ kmph

Speed of the boat A in still water= $16+12=28$ kmph

Speed of the boat B in still water= $70-28=42$ kmph

Downstream speed of the boat B= $42+12=54$ kmph

Required time= $270/54=5$ hours

98) Answer: D

Let the side of the square= $5x$

Breadth of the rectangle= $5x*60/100=3x$

Length of the rectangle= $3x*4/3=4x$

$$4x*3x+(5x)^2=925$$

$$x^2(12+25)=925$$

$$x^2=25$$

$$x=5$$

Side of the square= $5*5=25$ cm

Required area of the rectangle= $925-25*25=925-625=300$ cm²

99) Answer: D

Let the number of boy students in the school= $7x$

And the number of girl students in the school= $5x$

$$7x*5/7-5x*60/100=60$$

$$5x-3x=60$$

$$x=30$$

Required average= $(7*30+5*30)/2=360/2=180$

100) Answer: B

$$\text{Kala} = 4a$$

$$\text{Mala} = 4a * 125/100 = 5a$$

$$(4a + 5a)/2 = x + 6$$

$$9a = 2x + 12 \text{ -----(1)}$$

$$\text{Bala} = 4a - 7$$

$$\text{Bala} + 5 = x$$

$$\text{Bala} = x - 5$$

$$x - 5 = 4a - 7$$

$$x - 4a = -2 \text{ -----(2)}$$

$$2x - 8a = -4$$

IDBI Executive Previous Year Paper – English Version

$$2x - 9a = -12$$

$$a = 8$$

$$x = 60/2 = 30$$

Directions (101-105):

101) Answer: C

102) Answer: D

103) Answer: D

104) Answer: C

105) Answer: E

Final Arrangement

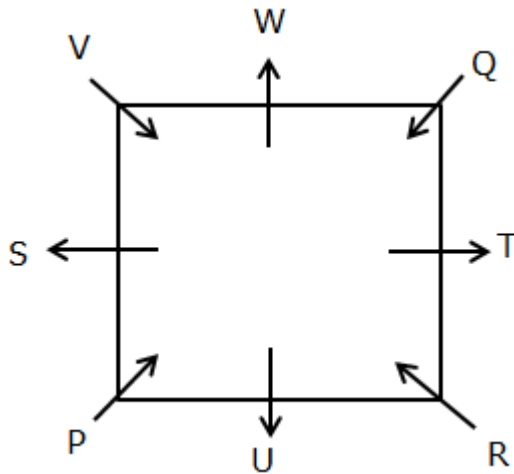

We have,

- S sits third to the left of R who does not sit on the side of the table.
- V sits second to the right of Q who neither sits adjacent to S nor R.

From the above condition, there are two possibilities.

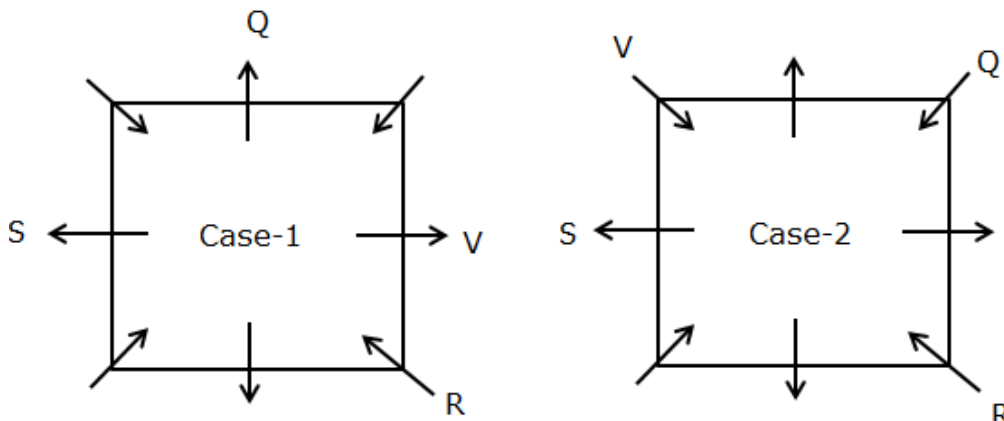

IDBI Executive Previous Year Paper – English Version

Again we have,

- The number of persons sitting between R and V is the same as the number of persons sitting between Q and P.

From the above condition, there are three possibilities.

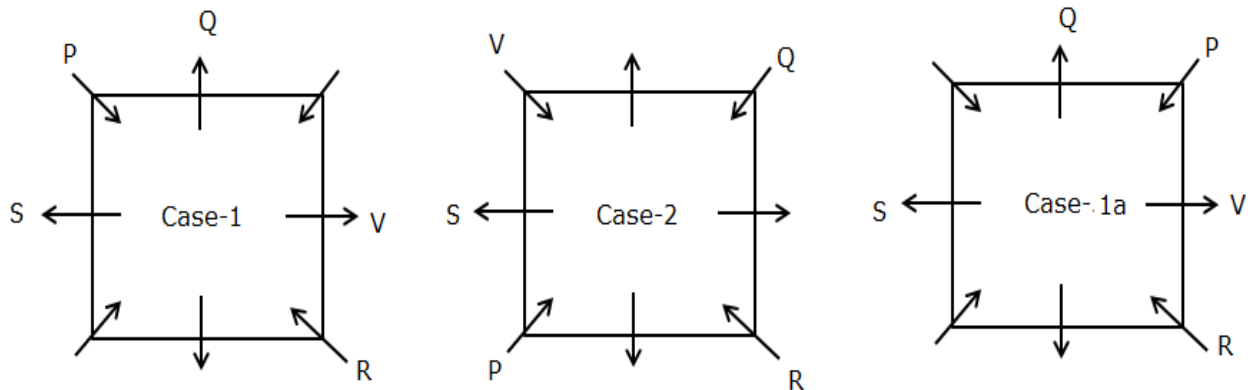

Again we have,

- T sits second to the left of U.
- The number of persons sitting between W and V is one less than the number of persons sitting between S and U when counted from the left of both W and S.

From the above condition, case1 and case1a get eliminated. Case2 shows the final arrangement.

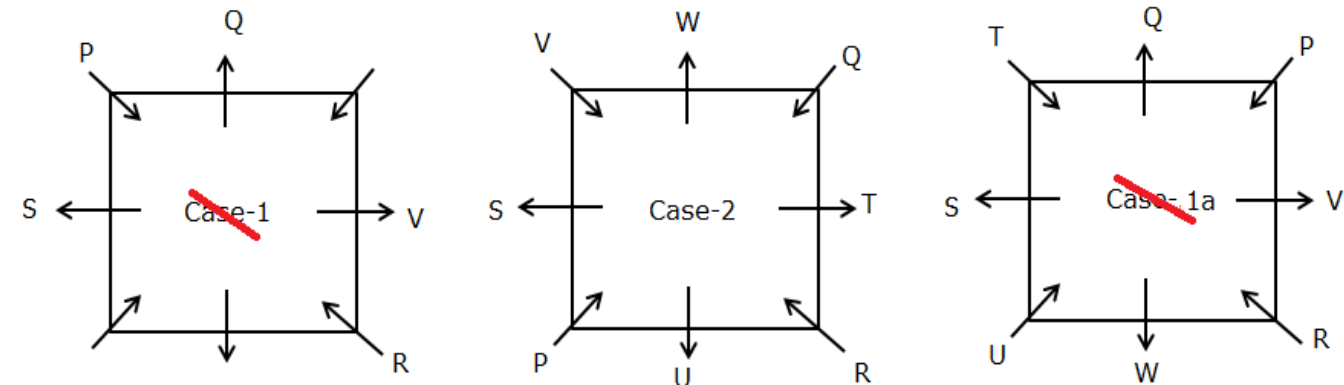

106. Answer: A

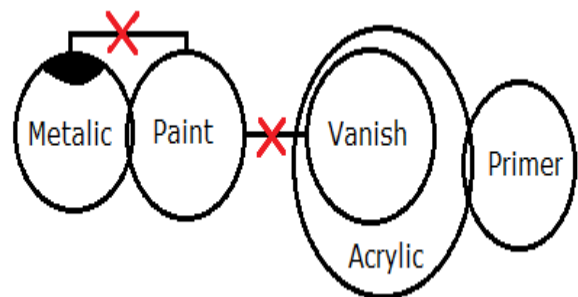

IDBI Executive Previous Year Paper – English Version

107. Answer: E

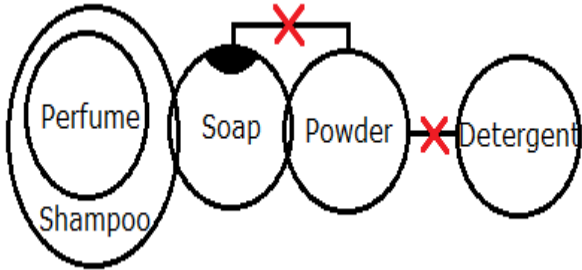

108. Answer: D

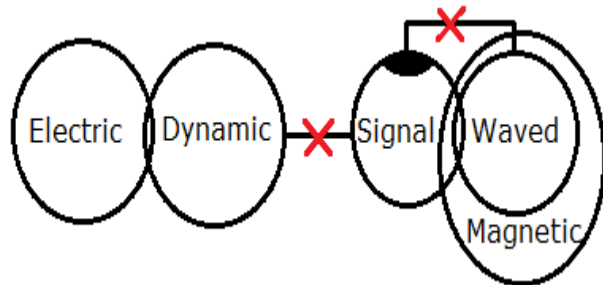

109. Answer: C

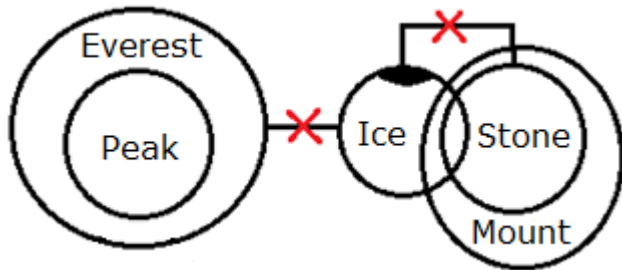

110. Answer: A

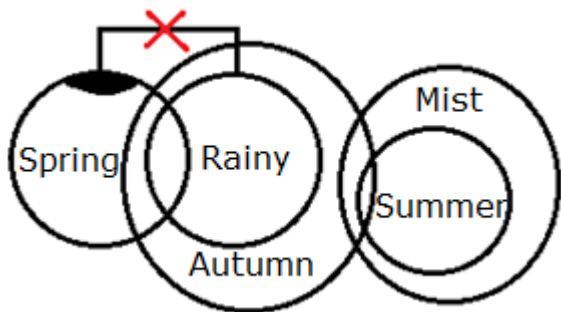

Directions (111-113):

111. Answer: A

112. Answer: C

113. Answer: B

D > F > B > G > E > C > A



114. Answer: A

219846357

1 2 3 4 5 6 7 8 9

Hence, option A is correct.

115. Answer: C

ERGONOMIC

FQHNONNH

Hence, option C is correct.

116. Answer: C

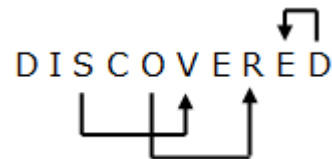

Hence, option c is correct.

Direction (117-121):

117. Answer: B

118. Answer: D

119. Answer: E

IDBI Executive Previous Year Paper – English Version

120. Answer: A

121. Answer: B

Final arrangements:

Date Month	11th	22nd
March	S	Q
April	W	R
May	P	V
June	U	T

Here we have,

W went on an odd numbered date of the month having 30 days.

Only one person went between W and P.

	Case-I		Case-II		Case-III	
Date Month	11th	22nd	11th	22nd	11th	22nd
March	P					
April	W		W			
May			P		P	
June					W	

Again we have,

V went immediately before U but both went in different months.

Two persons went between U and R.

R did not go after P.

	Case-I	Case-II	Case-III			
Date Month	11th	22nd	11th	22nd	11th	22nd
March	P	R				V

April	W	V	W	R	U	
May	U		P	V	P	R
June			U		W	

Again we have,

The number of persons went between S and R is same as between P and T.

T went one of the months after S.

Date Month	11th	22nd
March	S	Q
April	W	R
May	P	V
June	U	T

Direction (122-126):

122) Answer: B

123) Answer: A

124. Answer: A

125. Answer: D

126. Answer: B

Direction (127-129):

127. Answer: A

128. Answer: C

129. Answer: B

IDBI Executive Previous Year Paper – English Version

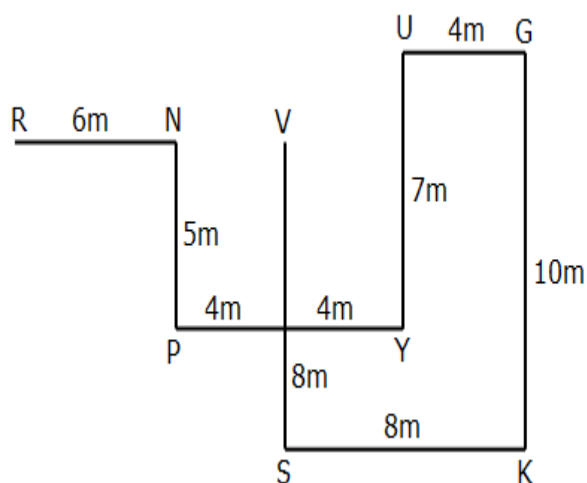

Directions (130-134):

130) Answer: E

131) Answer: B

132) Answer: D

133) Answer: E

134) Answer: B

Final Arrangement

Shelves	Boxes
10	U
9	V
8	Y
7	P
6	X
5	Q
4	S
3	R
2	W
1	T

We have,

- Atmost two boxes are kept below box T.
- Box X is kept two boxes below box Y and kept immediately above box Q.
- Box Q is kept four boxes above box T.

From the above condition, there are three possibilities.

Shelves	Case-1	Case-2	Case-3
10		Y	
9			Y
8	Y	X	
7		Q	X
6	X		Q
5	Q		
4			
3		T	
2			T
1	T		

Again we have,

- The number of boxes kept above box Y is the same as the number of boxes kept below box R.
- Box W is kept two boxes below box S which is kept adjacent to box Q.

From the above condition, Case-3 gets eliminated.

Shelves	Case-1	Case-2	Case-3
10		Y	
9			Y
8	Y	X	

IDBI Executive Previous Year Paper – English Version

7		Q	X
6	X	S	Q
5	Q		
4	S	W	
3	R	T	
2	W		T
1	T	R	

Again we have,

- The number of boxes kept between X and S is the same as the number of boxes kept between V and P.
- Box P is kept below box Y.

From the above condition, case-2 gets eliminated.

Case-1 shows the final arrangement.

Shelves	Case-1	Case-2
10	U	Y
9	V	
8	Y	X
7	P	Q
6	X	S
5	Q	
4	S	W
3	R	T
2	W	
1	T	R

Direction (135-137):

135. Answer: C

136. Answer: D

137. Answer: B

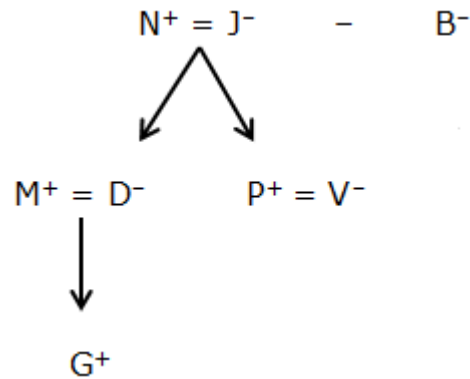

Directions (138-142):

138) Answer: D

139) Answer: A

140) Answer: B

141) Answer: B

142) Answer: C

Final Arrangement

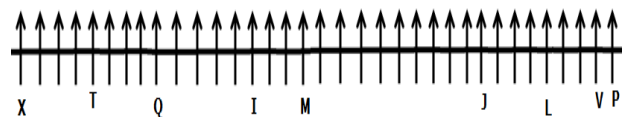

We have,

- Q sits fifth to the left of I.
- Only two persons are sitting between I and M.

From the above condition, there are two possibilities.

IDBI Executive Previous Year Paper – English Version

Case1

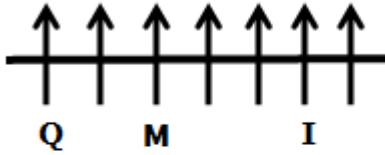

Case2

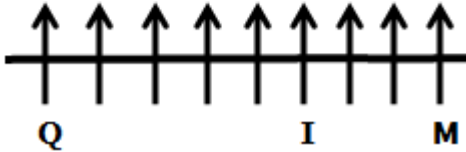

Again we have,

- The number of persons sitting between Q and M is two less than the number of persons sitting between M and J.
- I and J are not immediate neighbors.

From the above condition, there are three possibilities.

Case1

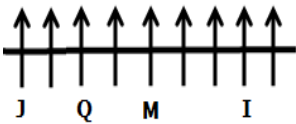

Case2

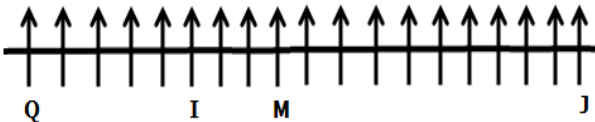

Case2a



Again we have,

- L sits fourth to the right of J.
- X sits eighth to the left of Q.

- T sits exactly in the middle of Q and X who sits on one of the ends.

From the above condition, case1 gets eliminated.

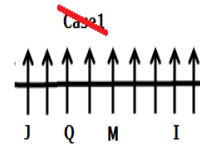

Case2

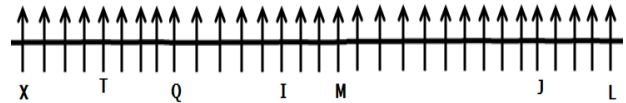

Case2a

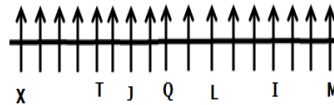

Again we have,

- The number of persons sits to the left of T is the same as the persons sits to the right of L.
- P sits immediate right of V.
- V sits to the right of J.
- More than five persons sit between J and V.

From the above condition, case2a gets eliminated.

Case2 shows the final arrangement.

Case2

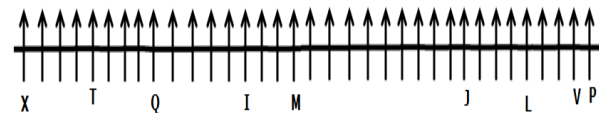

~~Case2a~~

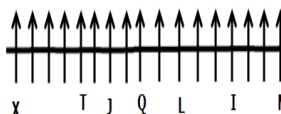

Direction (143-146):

143. Answer: D

IDBI Executive Previous Year Paper – English Version

144. Answer: C

145. Answer: E

146. Answer: B

From the given information, the following was determined.

Word	Code
Vaccine	nj
From	ug
Oxford	tr
Various	cy
Gain/money	oh/mn
Trial/outdated	sl/ps
Different/melody/moment	hd/io/ks

147. Answer: E

The protest has paralyzed the country for nearly two weeks. Prime Minister of Lebanon, Saad Hariri has resigned bowing to one of the central demands of anti-government demonstrators shortly after baton-wielding Hezbollah supporters rampaged through the main protest camp in Beirut. Both the statements I and II are effects of some common cause.

148. Answer: B

The Virtual Police Station has been set up on the suggestion of Andhra University's Vice-Chancellor to make it easy for students to report their grievances. The initiative is expected to help bridge

the gap between students and the police department. So only argument II is strong.

149. Answer: E

The Reserve Bank has imposed a penalty of Rs 35 lakhs on Tamilnad Mercantile Bank for the reason of non-compliance with certain provisions of directions issued by RBI on fraud classification and reporting by commercial banks. So, Both the statements I and II are effects of some common cause

150. Answer: E

The Coal Ministry will establish 'Sustainable Development Cell' (SDC) for promoting sustainable coal mining in the country. The Cell will advise, mentor, plan and monitor the mitigation measures taken by the coal companies for maximizing the utilization of available resources in a sustainable way, minimizing the adverse impact of mining and mitigating it for further eco-system services. So, both assumptions I and II are implicit.