

FINAL JEE–MAIN EXAMINATION – APRIL, 2023

(Held On Monday 10th April, 2023)

TIME : 9 : 00 AM to 12 : 00 NOON

MATHEMATICS

TEST PAPER WITH SOLUTION

SECTION-A

1. Let O be the origin and the position vector of the point P be $-\hat{i} - 2\hat{j} + 3\hat{k}$. If the position vectors of the points A, B and C are $-2\hat{i} + \hat{j} - 3\hat{k}$, $2\hat{i} + 4\hat{j} - 2\hat{k}$ and $-4\hat{i} + 2\hat{j} - \hat{k}$ respectively then the projection of the vector \overrightarrow{OP} on a vector perpendicular to the vectors \overrightarrow{AB} and \overrightarrow{AC} is

- (1) 3 (2) $\frac{8}{3}$
 (3) $\frac{10}{3}$ (4) $\frac{7}{3}$

Official Ans. by NTA (1)

Sol. $AB = OB - OA$

$$= (2\hat{i} + 4\hat{j} - 2\hat{k}) - (-2\hat{i} + \hat{j} - 3\hat{k})$$

$$= 4\hat{i} + 3\hat{j} + \hat{k}$$

$$\overrightarrow{AC} = \overrightarrow{OC} - \overrightarrow{OA} = -2\hat{i} + \hat{j} + 2\hat{k}$$

$$\overrightarrow{AB} \times \overrightarrow{AC} = 5\hat{i} - 10\hat{j} + 10\hat{k}$$

$$\overrightarrow{OP} = -\hat{i} - 2\hat{j} + 3\hat{k}$$

Projection

$$= \frac{(\overrightarrow{OP}) \cdot (\overrightarrow{AB} \times \overrightarrow{AC})}{|\overrightarrow{AB} \times \overrightarrow{AC}|} = 3$$

2. Let the ellipse E : $x^2 + 9y^2 = 9$ intersect the positive x- and y-axes at the points A and B respectively. Let the major axis of E be a diameter of the circle C. Let the line passing through A and B meet the circle C at the point P. If the area of the triangle which vertices A, P and the origin O is $\frac{m}{n}$, where

m and n are coprime, then m - n is equal to

- (1) 18 (2) 16
 (3) 17 (4) 15

Official Ans. by NTA (3)

Sol.

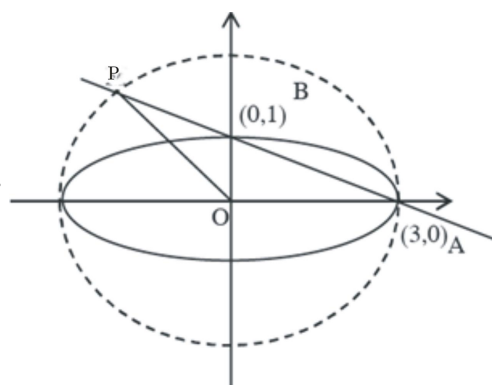

For line AB $x + 3y = 3$ and circle is $x^2 + y^2 = 9$

$$(3 - 3y)^2 + y^2 = 9$$

$$\Rightarrow 10y^2 - 18y = 0$$

$$\Rightarrow y = 0, \frac{9}{5}$$

$$\therefore \text{Area} = \frac{1}{2} \times 3 \times \frac{9}{5} = \frac{27}{10}$$

$$m - n = 17$$

3. If $f(x) = \frac{(\tan 1^\circ)x + \log_e(123)}{x \log_e(1234) - (\tan 1^\circ)}$, $x > 0$, then

the least value of $f(f(x)) + f\left(f\left(\frac{4}{x}\right)\right)$ is

- (1) 8
 (2) 4
 (3) 2
 (4) 0

Official Ans. by NTA (2)

Sol. Let $f(x) = \frac{Ax+B}{Cx-A}$

$$f(f(x)) = \frac{A\left(\frac{Ax+B}{Cx-A}\right) + B}{C\left(\frac{Ax+B}{Cx-A}\right) - A} = x$$

$$f\left(f\left(\frac{4}{x}\right)\right) = \frac{4}{x}$$

$$f(f(x)) + f\left(f\left(\frac{4}{x}\right)\right) = x + \frac{4}{x} \geq 4 \text{ (by A.M.} \geq \text{G.M.)}$$

4. A square piece of tin of side 30 cm is to be made into a box without top by cutting a square from each corner and folding up the flaps to form a box. If the volume of the box is maximum, then its surface area (in cm^2) is equal to

- (1) 675 (2) 1025
(3) 800 (4) 900

Official Ans. by NTA (3)

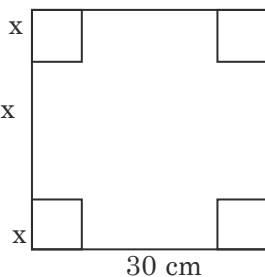

Sol. $30 - 2x$

$$\text{Volume (V)} = x(30 - 2x)^2$$

$$\frac{dV}{dx} = (30 - 2x)(30 - 6x) = 0$$

$$x = 5 \text{ cm}$$

$$\text{Surface area} = 4 \times 5 \times 20 + (20)^2 = 800 \text{ cm}^2$$

5. Let f be a differentiable function such that

$$x^2 f(x) - x = 4 \int_0^x t f(t) dt, f(1) = \frac{2}{3}.$$

Then $18f(3)$ is equal to

- (1) 160 (2) 210
(3) 180 (4) 150

Official Ans. by NTA (1)

- Sol.** Differentiate the given equation

$$\Rightarrow 2xf(x) + x^2 f'(x) - 1 = 4xf(x)$$

$$\Rightarrow x^2 \frac{dy}{dx} - 2xy = 1$$

$$\Rightarrow \frac{dy}{dx} + \left(-\frac{2}{x}\right)y = \frac{1}{x^2}$$

$$I.F. = e^{\int -\frac{2}{x} dx} = \frac{1}{x^2}$$

$$\therefore y \left(\frac{1}{x^2}\right) = \int \frac{1}{x^4} dx$$

$$\Rightarrow \frac{y}{x^2} = \frac{-1}{3x^3} + c$$

$$\Rightarrow y = -\frac{1}{3x^3} + c$$

$$\Rightarrow y = -\frac{1}{3x} + cx^2$$

$$\therefore f(1) = \frac{2}{3} = -\frac{1}{3} + c \Rightarrow c = 1$$

$$f(x) = -\frac{1}{3x} + x^2$$

$$18f(3) = 160$$

6. A line segment AB of length λ moves such that the points A and B remain on the periphery of a circle of radius λ . Then the locus of the point, that divides the line segment AB in the ratio 2 : 3, is a circle of radius

- (1) $\frac{3}{5}\lambda$ (2) $\frac{\sqrt{19}}{7}\lambda$
(3) $\frac{2}{3}\lambda$ (4) $\frac{\sqrt{19}}{5}\lambda$

Official Ans. by NTA (4)

Sol. $\left(\frac{\lambda}{\sqrt{2}} \sin \theta, \frac{-\lambda}{\sqrt{2}} \cos \theta\right) A \left(\frac{3}{5}, \frac{2}{5}\right) P(h,k) B \left(\frac{\lambda}{\sqrt{2}} \cos \theta, \frac{\lambda}{\sqrt{2}} \sin \theta\right)$

$$h = \frac{\frac{2\lambda}{\sqrt{2}} \sin \theta + 3 \times \frac{\lambda}{\sqrt{2}} \cos \theta}{5}$$

$$k = \frac{\frac{-2\lambda}{\sqrt{2}} \cos \theta + \frac{3\lambda}{\sqrt{2}} \sin \theta}{5}$$

$$h^2 + k^2 = \frac{19\lambda^2}{5}$$

$$r = \frac{\sqrt{19}\lambda}{5}$$

7. Let the complex number $z = x + iy$ be such that

$\frac{2z-3i}{2z+i}$ is purely imaginary. If $x + y^2 = 0$, then

$y^4 + y^2 - y$ is equal to :

- (1) $\frac{3}{2}$ (2) $\frac{4}{3}$
 (3) $\frac{2}{3}$ (4) $\frac{3}{4}$

Official Ans. by NTA (4)

Sol. $\frac{2z-3i}{2z+i}$ is purely imaginary

$$\therefore \frac{2z-3i}{2z+i} + \frac{2\bar{z}+3i}{2\bar{z}-i} = 0$$

$$z = x + iy$$

$$\Rightarrow 4x^2 + 4y^2 - 4y - 3 = 0$$

$$\text{Given that } x + y^2 = 0$$

$$y^4 + y^2 - y = 3/4$$

8. $96 \cos \frac{\pi}{33} \cos \frac{2\pi}{33} \cos \frac{4\pi}{33} \cos \frac{8\pi}{33} \cos \frac{16\pi}{33}$ is

equal to

- (1) 3 (2) 2 (3) 4 (4) 1

Official Ans. by NTA (1)

Sol. $P = 96 \cos \frac{\pi}{33} \cos \frac{2\pi}{33} \cos \frac{4\pi}{33} \cos \frac{8\pi}{33} \cos \frac{16\pi}{33}$

$$2P \times \sin \frac{\pi}{33} = 96 \times 2 \sin \frac{\pi}{33} \cos \frac{\pi}{33} \cos \frac{2\pi}{33} \cos \frac{4\pi}{33} \cos \frac{8\pi}{33} \cos \frac{16\pi}{33}$$

$$2P \times \sin \frac{\pi}{33} = 6 \times \sin \frac{32\pi}{33} = 6 \sin \frac{\pi}{33}$$

$$P = 3$$

9. If A is a 3×3 matrix and $|A| = 2$, then

$|3 \text{adj}(|3A|A^2)|$ is equal to

- (1) $3^{11} \cdot 6^{10}$ (2) $3^{12} \cdot 6^{10}$
 (3) $3^{10} \cdot 6^{11}$ (4) $3^{12} \cdot 6^{11}$

Official Ans. by NTA (1)

Sol. $|3 \text{adj} |3A|A^2| = 3^3 | \text{adj}(54A^2) | = 3^3 \cdot |54A^2|^2$

$$= 3^3 \times 54^6 \times |A|^4 = 3^{11} \times 6^{10}$$

10. The slope of tangent at any point (x, y) on a curve

$y = y(x)$ is $\frac{x^2 + y^2}{2xy}$, $x > 0$. If $y(2) = 0$, then a value

of $y(8)$ is

- (1) $-2\sqrt{3}$ (2) $4\sqrt{3}$
 (3) $2\sqrt{3}$ (4) $-4\sqrt{2}$

Official Ans. by NTA (2)

Sol. $\frac{dy}{dx} = \frac{1 + \left(\frac{y}{x}\right)^2}{2\left(\frac{y}{x}\right)}$

Let $y = tx$

$$\Rightarrow t + x \frac{dt}{dx} = \frac{1+t^2}{2t}$$

$$\Rightarrow x \frac{dt}{dx} = \frac{1-t^2}{2t}$$

$$\Rightarrow \int \frac{2t}{1-t^2} dt = \int \frac{dx}{x}$$

$$\Rightarrow \ln|1-t^2| = \ln x + \ln c$$

$$\Rightarrow (1-t^2)(cx) = 1$$

$$\Rightarrow \left(1 - \frac{y^2}{x^2}\right) cx = 1$$

$$y(2) = 0 \Rightarrow c = \frac{1}{2}$$

$$\left(1 - \frac{y^2}{x^2}\right) \cdot \frac{1}{2} x = 1$$

at $x = 8$

$$\left(1 - \frac{y^2}{64}\right) \times \frac{8}{2} = 1$$

$$y = \pm 4\sqrt{3}$$

11. For the system of linear equations

$$2x - y + 3z = 5$$

$$3x + 2y - z = 7$$

$$4x + 5y + \alpha z = \beta$$

Which of the following is NOT correct ?

- (1) The system has infinitely many solutions for $\alpha = -5$ and $\beta = 9$
- (2) The system has a unique solution for $\alpha \neq -5$ and $\beta = 8$
- (3) The system has infinitely many solutions for $\alpha = -6$ and $\beta = 9$
- (4) The system is inconsistent for $\alpha = -5$ and $\beta = 8$

Official Ans. by NTA (3)

Sol.
$$\Delta = \begin{vmatrix} 2 & -1 & 3 \\ 3 & 2 & -1 \\ 4 & 5 & \alpha \end{vmatrix} = 7(\alpha + 5)$$

$$\Delta_1 = \begin{vmatrix} 5 & -1 & 3 \\ 7 & 2 & -1 \\ \beta & 5 & \alpha \end{vmatrix} = 17\alpha - 5\beta + 130$$

$$\Delta_2 = \begin{vmatrix} 2 & 5 & 3 \\ 3 & 7 & -1 \\ 4 & \beta & \alpha \end{vmatrix} = -11\beta + \alpha + 104$$

$$\Delta_3 = \begin{vmatrix} 2 & -1 & 5 \\ 3 & 2 & 7 \\ 4 & 5 & \beta \end{vmatrix} = 7(\beta - 9)$$

For infinitely many solutions

$$\Delta = \Delta_1 = \Delta_2 = \Delta_3 = 0$$

For $\alpha = -5$ and $\beta = 9$

Hence option (3) is incorrect

12. Let N denotes the sum of the numbers obtained when two dice are rolled. If the probability that

$2^N < N!$ is $\frac{m}{n}$, where m and n are coprime, then

$4m - 3n$ is equal to

- (1) 8
- (2) 16
- (3) 10
- (4) 12

Official Ans. by NTA (1)

Sol. $N =$ Sum of the numbers when two dice are rolled such that $2^N < N!$

$$\Rightarrow 4 \leq N \leq 12$$

Probability that $2^N \geq N!$

$$\text{Now } P(N=2) + P(N=3) = \frac{1}{36} + \frac{2}{36} = \frac{3}{36} = \frac{1}{12}$$

$$\text{Required probability} = 1 - \frac{1}{12} = \frac{11}{12} = \frac{m}{n}$$

$$4m - 3n = 8$$

13. Let P be the point of intersection of the line

$$\frac{x+3}{3} = \frac{y+2}{1} = \frac{1-z}{2} \text{ and the plane } x + y + z = 2.$$

If the distance of the point P from the plane $3x - 4y + 12z = 32$ is q , then q and $2q$ are the roots of the equation

- (1) $x^2 - 18x - 72 = 0$
- (2) $x^2 + 18x + 72 = 0$
- (3) $x^2 - 18x + 72 = 0$
- (4) $x^2 + 18x - 72 = 0$

Official Ans. by NTA (3)

Sol. $P = (3\lambda - 3, \lambda - 2, 1 - 2\lambda)$
 P lies on the plane, $x + y + z = 2$
 $\Rightarrow \lambda = 3$
 $P = (6, 1, -5)$
 $q = \left| \frac{18 - 4 - 60 - 32}{\sqrt{9 + 16 + 144}} \right| = \frac{78}{13} = 6$
 $q = 6, 2q = 12$
Equation, $x^2 - 18x + 72 = 0$

14. The negation of the statement
 $(p \vee q) \wedge (q \vee (\sim r))$ is
(1) $((\sim p) \vee r) \wedge (\sim q)$
(2) $((\sim p) \vee (\sim q)) \wedge (\sim r)$
(3) $((\sim p) \vee (\sim q)) \vee (\sim r)$
(4) $(p \vee r) \wedge (\sim q)$

Official Ans. by NTA (1)

Sol. $\sim [(p \vee q) \wedge (q \vee (\sim p))]$
 $\Rightarrow \sim (p \wedge q) \vee \sim (q \vee (\sim p))$
 $\Rightarrow (\sim p \wedge \sim q) \vee (\sim q \wedge p)$
Apply distribution law
 $\Rightarrow \sim q \wedge (\sim p \vee p)$
 $\Rightarrow (\sim p \vee p) \wedge (\sim q)$

15. If the coefficient of x^7 in $\left(ax - \frac{1}{bx^2}\right)^{13}$ and the coefficient of x^{-5} in $\left(ax + \frac{1}{bx^2}\right)^{13}$ are equal, then a^4b^4 is equal to :
(1) 44
(2) 22
(3) 11
(4) 33

Official Ans. by NTA (2)

Sol. $T_{r+1} = {}^{13}C_r (ax)^{13-r} \left(-\frac{1}{bx^2}\right)^r$
 $= {}^{13}C_r (a)^{13-r} \left(-\frac{1}{b}\right)^r x^{13-3r}$
 $13 - 3r = 7 \Rightarrow r = 2$
Coefficient of $x^7 = {}^{13}C_2 (a)^{11} \cdot \frac{1}{b^2}$
In the other expansion $T_{r+1} = {}^{13}C_r (ax)^{13-r} \left(\frac{1}{bx^2}\right)^r$

$13 - 3r = -5 \Rightarrow r = 6$

Coefficient of $x^{-5} = {}^{13}C_6 (a)^7 \cdot \frac{1}{b^6}$

$${}^{13}C_2 \frac{a^{11}}{b^2} = {}^{13}C_6 \frac{a^7}{b^6}$$

$$a^4 b^4 = \frac{{}^{13}C_6}{{}^{13}C_2} = 22$$

16. Let two vertices of triangle ABC be (2, 4, 6) and (0, -2, -5), and its centroid be (2, 1, -1). If the image of third vertex in the plane $x + 2y + 4z = 11$ is (α, β, γ) , then $\alpha\beta + \beta\gamma + \gamma\alpha$ is equal to

- (1) 72 (2) 74
(3) 76 (4) 70

Official Ans. by NTA (2)

Sol. Given, A(2, 4, 6), B(0, -2, -5)
G(2, 1, -1)

Let vertex C(x, y, z)
 $\frac{2+0+x}{3} = 2 \Rightarrow x = 4$

$$\frac{4-2+y}{3} = 1 \Rightarrow y = 1$$

$$\frac{6-5+z}{3} = -1 \Rightarrow z = -4$$

Third vertex, C(4, 1, -4)

Then image of vertex in the plane let image (α, β, γ)

i.e., $\frac{\alpha-4}{1} = \frac{\beta-1}{2} = \frac{\gamma+4}{4} = \frac{-2(4+2-16-11)}{21}$

$$\alpha = 6, \beta = 5, \gamma = 4$$

$$\alpha\beta + \beta\gamma + \gamma\alpha = 30 + 20 + 24 = 74$$

17. The shortest distance between the lines $\frac{x+2}{1} = \frac{y}{-2} = \frac{z-5}{2}$ and $\frac{x-4}{1} = \frac{y-1}{2} = \frac{z+3}{0}$ is

- (1) 6 (2) 9
(3) 7 (4) 8

Official Ans. by NTA (2)

Sol. Given lines

$$\frac{x+2}{1} = \frac{y}{-2} = \frac{z-5}{2} \quad \& \quad \frac{x-4}{1} = \frac{y-1}{2} = \frac{z+3}{0}$$

Formula for shortest distance

$$\text{S.D.} = \frac{\begin{vmatrix} x_2 - x_1 & y_2 - y_1 & z_2 - z_1 \\ a_1 & b_1 & c_1 \\ a_2 & b_2 & c_2 \end{vmatrix}}{\begin{vmatrix} \hat{i} & \hat{j} & \hat{k} \\ a_1 & b_1 & c_1 \\ a_2 & b_2 & c_2 \end{vmatrix}}$$

$$= \frac{\begin{vmatrix} 6 & 1 & -8 \\ 1 & -2 & 2 \\ 1 & 2 & 0 \end{vmatrix}}{\begin{vmatrix} \hat{i} & \hat{j} & \hat{k} \\ 1 & -2 & 2 \\ 1 & 2 & 0 \end{vmatrix}} = \frac{54}{6} = 9$$

18. If $I(x) = \int e^{\sin^2 x} (\cos x \sin 2x - \sin x) dx$ and

$I(0) = 1$, then $I\left(\frac{\pi}{3}\right)$ is equal to

- (1) $-\frac{1}{2}e^{\frac{3}{4}}$
(2) $e^{\frac{3}{4}}$
(3) $\frac{1}{2}e^{\frac{3}{4}}$
(4) $-e^{\frac{3}{4}}$

Official Ans. by NTA (3)

Sol. $I(x) = \int \frac{e^{\sin^2 x} \cdot \sin 2x \cdot \cos x}{I} dx - \int e^{\sin^2 x} \cdot \sin x dx$

$$\Rightarrow I(x) = e^{\sin^2 x} - \int (-\sin x) \cdot e^{\sin^2 x} dx - \int e^{\sin^2 x} \cdot \sin x dx$$

$$\Rightarrow I(x) = e^{\sin^2 x} \cdot \cos x + c$$

Put $x = 0, c = 0$

$$\therefore I\left(\frac{\pi}{3}\right) = e^{\frac{3}{4}} \cdot \cos \frac{\pi}{3} = \frac{1}{2} e^{\frac{3}{4}}$$

19. Let the first term a and the common ratio r of a geometric progression be positive integers. If the sum of its squares of first three terms is 33033, then the sum of these three terms is equal to

- (1) 231
(2) 210
(3) 220
(4) 241

Official Ans. by NTA (1)

Sol. $\Rightarrow a^2 + a^2 r^2 + a^2 r^4 = 33033$

$$\Rightarrow a^2 (r^4 + r^2 + 1) = 3 \times 7 \times 11^2 \times 13 \Rightarrow a = 11$$

$$\Rightarrow r^4 + r^2 + 1 = 273 \Rightarrow r^4 + r^2 - 272 = 0$$

$$\Rightarrow (r^2 + 17)(r^2 - 16) = 0 \Rightarrow r^2 = 16 \Rightarrow r = \pm 4$$

$$t_1 + t_2 + t_3 = a + ar + ar^2 = 11 + 44 + 176 = 231$$

20. An arc PQ of a circle subtends a right angle at its centre O. The mid point of the arc PQ is R. If $\overline{OP} = \vec{u}$, $\overline{OR} = \vec{v}$ and $\overline{OQ} = \alpha \vec{u} + \beta \vec{v}$, then α, β^2 are the roots of the equation

(1) $x^2 - x - 2 = 0$

(2) $3x^2 + 2x - 1 = 0$

(3) $x^2 + x - 2 = 0$

(4) $3x^2 - 2x - 1 = 0$

Official Ans. by NTA (1)

Sol.

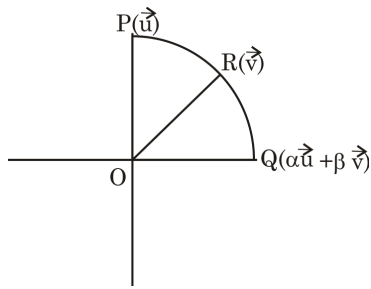

$$|\vec{u}| = |\vec{v}| = |\alpha\vec{u} + \beta\vec{v}|$$

$$(\vec{u}) \cdot (\alpha\vec{u} + \beta\vec{v}) = 0$$

$$\vec{u} \cdot \vec{v} = |u||v| \cos 45^\circ$$

$$\alpha = -\frac{\beta}{\sqrt{2}}$$

$$= |\alpha\vec{u} + \beta\vec{v}| = r$$

$$\alpha^2 + \beta^2 + \sqrt{2}\alpha\beta = 1$$

$$\alpha = -1, \beta^2 = 2$$

SECTION-B

21. The coefficient of x^7 in $(1 - x + 2x^3)^{10}$ is _____.

Official Ans. by NTA (960)

Sol. General term = $\frac{10!}{r_1! r_2! r_3!} (-1)^{r_2} \cdot (2)^{r_3} x^{r_2 + 3r_3}$

where $r_1 + r_2 + r_3 = 10$ and $r_2 + 3r_3 = 7$

r_1	r_2	r_3
3	7	0
5	4	1
7	1	2

Required coefficient

$$= \frac{10!}{3!7!} (-1)^7 + \frac{10!}{5!4!} (-1)^4 (2) + \frac{10!}{7!2!} (-1)^1 (2)^2$$

$$= -120 + 2520 - 1440 = 960$$

22. Let $f: (-2, 2) \rightarrow \mathbb{R}$ be defined by

$$f(x) = \begin{cases} x[x] & , -2 < x < 0 \\ (x-1)[x] & , 0 \leq x < 2 \end{cases}$$

Where $[x]$ denotes the greatest integer function. If m and n respectively are the number of points in $(-2, 2)$ at which $y = |f(x)|$ is not continuous and not differentiable, then $m + n$ is equal to _____.

Official Ans. by NTA (4)

Sol. $f(x) = \begin{cases} x[x] & , -2 < x < 0 \\ (x-1)[x] & , 0 \leq x < 2 \end{cases}$

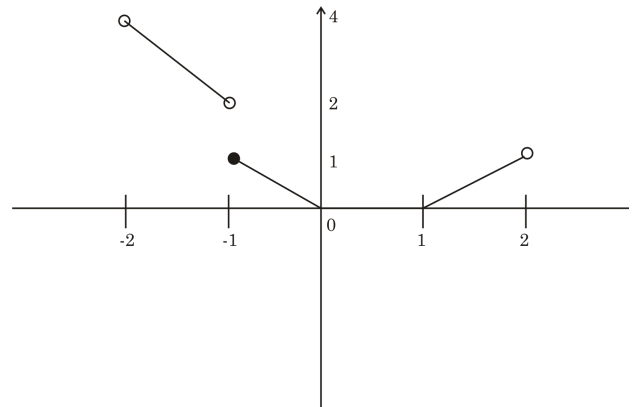

$$|f(x)| = \text{Remain same}$$

$$m = 1, n = 3$$

$$m + n = 4$$

23. The sum of all those terms, of the arithmetic progression 3, 8, 13,..... 373, which are not divisible by 3, is equal to _____.

Official Ans. by NTA (9525)

$$\text{Required sum} = (3 + 8 + 13 + 18 + \dots + 373)$$

$$- (3 + 18 + 33 + \dots + 363)$$

$$= \frac{75}{2} (3 + 373) - \frac{25}{2} (3 - 363)$$

$$= 75 \times 188 - 25 \times 183$$

$$= 9525$$

24. Let a common tangent to the curves $y^2 = 4x$ and $(x - 4)^2 + y^2 = 16$ touch the curves at the points P and Q. Then $(PQ)^2$ is equal to _____.

Official Ans. by NTA (32)

Sol. General tangent of slope m to the circle $(x - 4)^2 + y^2 = 16$ is given by $y = m(x - 4) \pm 4\sqrt{1 + m^2}$

General tangent of slope m to the parabola $y^2 = 4x$

is given by $y = mx + \frac{1}{m}$

For common tangent $\frac{1}{m} = -4m \pm 4\sqrt{1 + m^2}$

$$m = \pm \frac{1}{2\sqrt{2}}$$

Point of contact on parabola is $(8, 4\sqrt{2})$

Length of tangent PQ from $(8, 4\sqrt{2})$ on the circle

$(x - 4)^2 + y^2 = 16$ is equal to

$$\sqrt{(8-4)^2 + (4\sqrt{2})^2} - 4 \text{ is equal to } \sqrt{32}$$

PQ^2 is equal to 32

25. The number of permutations, of the digits 1, 2, 3,7 without repetition, which neither contain the string 153 nor the string 2467, is _____.

Official Ans. by NTA (4898)

Sol. Digits $\rightarrow 1, 2, 3, 4, 5, 6, 7$

Total permutations = 7!

Let A = number of numbers containing string 153

Let B = number of numbers containing string 2467

$$n(A) = 5! \times 1 \quad \boxed{153} \quad 2467$$

$$n(B) = 4! \times 1 \quad \boxed{2467} \quad 153$$

$$n(A \cap B) = 2! \quad \boxed{153} \quad \boxed{2467}$$

$$n(A \cup B) = 5! + 4! - 2! = 142$$

$$n(\text{neither string 153 nor string 2467})$$

$$= \text{Total} - n(A \cup B)$$

$$= 7! - 142 = 4898$$

26. Let a, b, c be three distinct positive real numbers such that $(2a)^{\log_e a} = (bc)^{\log_e b}$ and $b^{\log_e 2} = a^{\log_e c}$.

Then $6a + 5bc$ is equal to _____.

Official Ans. by NTA (8)

Sol. $(2a)^{\ln a} = (bc)^{\ln b}$ $2a > 0, bc > 0$ $b^{\ln 2} = a^{\ln c}$

$$\ln a (\ln 2 + \ln a) = \ln b (\ln b + \ln c) \quad \left| \begin{array}{l} \ln 2 \cdot \ln b = \ln c \cdot \ln a \\ \alpha y = yz \end{array} \right.$$

$$\ln 2 = \alpha, \ln a = x_1, \ln b = y, \ln c = z$$

$$x(a+x) = y(y+z)$$

$$\alpha = \frac{xz}{y} \quad (2a)^{\ln a} = (2a)^0$$

$$x \left(\frac{xz}{y} + x \right) = y(y+z)$$

$$x^2(z+y) = y^2(y+z)$$

$$y+z=0 \text{ or } x^2 = y^2 \Rightarrow x = -y$$

$$bc = 1 \text{ or } ab = 1$$

$$(1) \text{ if } bc = 1 \Rightarrow (2a)^{\ln a} = 1 \begin{cases} a=1 \\ a=1/2 \end{cases}$$

$$(a, b, c) = \left(\frac{1}{2}, \lambda, \frac{1}{\lambda} \right), \lambda \neq 1, 2, \frac{1}{2}$$

$$\text{then } 6a + 5bc = 3 + 5 = 8$$

$$(II) (a, b, c) = \left(\lambda, \frac{1}{\lambda}, \frac{1}{2} \right), \lambda \neq 1, 2, \frac{1}{2}$$

In this situation infinite answer are possible

So, Bonus.

27. Let $y = p(x)$ be the parabola passing through the points $(-1, 0)$, $(0, 1)$ and $(1, 0)$. If the area of the region $\{(x, y) : (x+1)^2 + (y-1)^2 \leq 1, y \leq p(x)\}$

is A, then $12(\pi - 4A)$ is equal to _____.

Official Ans. by NTA (16)

Sol. There can be infinitely many parabolas through given points.

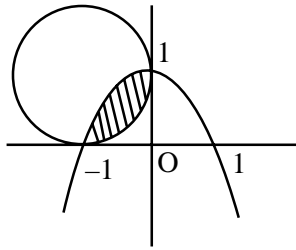

$$A = \int_{-1}^0 (1-x^2) - (x - \sqrt{1-(x+1)^2}) dx$$

$$= \int_{-1}^0 -x^2 + \sqrt{1-(x+1)^2} dx$$

$$= \left(-\frac{x^3}{3} + \frac{x+1}{2} = \sqrt{1-(x+1)^2} + \frac{1}{2} \cdot \sin^{-1} \left(\frac{x+1}{1} \right) \right)_{-1}^0$$

$$A = \frac{\pi}{4} - \left(\frac{1}{3} \right)$$

$$\therefore 12(\pi - 4A) = 12 \left(\pi - 4 \left(\frac{\pi}{4} - \frac{1}{3} \right) \right) = 16$$

This is possible only when axis of parabola is parallel to Y axis but is not given in question, so it is bonus.

28. If the mean of the frequency distribution

Class :	0-10	10-20	20-30	30-40	40-50
Frequency	2	3	x	5	4

is 28, then its variance is _____.

Official Ans. by NTA (151)

Sol. Given mean is = 28

$$\frac{2 \times 5 + 3 \times 15 + x \times 25 + 5 \times 35 + 4 \times 45}{14 + x} = 28$$

$$x = 6$$

$$\text{Variance} = \left(\frac{\sum x_i^2 f_i}{\sum f_i} \right) - (\text{mean})^2$$

$$\text{Variance} = \frac{2 \times 5^2 + 3 \times 15^2 + 6 \times 25^2 + 5 \times 35^2 + 4 \times 45^2}{20} - (28)^2$$

$$= 151$$

29. Some couples participated in a mixed doubles badminton tournament. If the number of matches played, so that no couple played in a match, is 840, then the total numbers of persons, who participated in the tournament, is _____.

Official Ans. by NTA (16)

Sol. ${}^n C_2 \times {}^{n-2} C_2 \times 2 = 840$

$$\Rightarrow n = 8$$

Therefore total persons = 16

30. The number of elements in the set $\{n \in \mathbb{Z} : |n^2 - 10n + 19| < 6\}$ is _____.

Official Ans. by NTA (6)

Sol. $-6 < n^2 - 10n + 19 < 6$

$$\Rightarrow n^2 - 10n + 25 > 0 \text{ and } n^2 - 10n + 13 < 6$$

$$(n-5)^2 > 0 \quad n \in [5 - 2\sqrt{3}, 5 + 2\sqrt{3}]$$

$$n \in \mathbb{R} - [5]$$

$$\therefore n \in [1.3, 8.3]$$

$$\Rightarrow n = 2, 3, 4, 6, 7, 8$$

PHYSICS

TEST PAPER WITH SOLUTION

SECTION-A

31. A physical quantity P is given as

$$P = \frac{a^2 b^3}{c \sqrt{d}}$$

The percentage error in the measurement of a, b, c and d are 1%, 2%, 3% and 4% respectively. The percentage error in the measurement of quantity P will be

- (1) 13% (2) 14%
 (3) 12% (4) 16%

Official Ans. by NTA (1)

Sol. $\frac{\Delta P}{P} \times 100\% = \left(2 \frac{\Delta a}{a} + 3 \frac{\Delta b}{b} + \frac{\Delta c}{c} + \frac{1}{2} \frac{\Delta d}{d} \right) \times 100\%$

$$= 2(1\%) + 3(2\%) + 3\% + \frac{1}{2} \times 4\% = 13\%$$

32. Assuming the earth to be a sphere of uniform mass density, the weight of a body at a depth $d = \frac{R}{2}$ from the surface of earth, if its weight on the surface of earth is 200 N, will be:

(Given R = Radius of earth)

- (1) 400 N (2) 500 N
 (3) 300 N (4) 100 N

Official Ans. by NTA (4)

Sol. $M = \frac{W}{g} = \frac{200}{10} = 20 \text{ kg}$

Acc. due to gravity at a depth $g' = g \left(1 - \frac{d}{R} \right)$

d → depth from surface

$$d = \frac{R}{2}$$

$$g' = g \left(1 - \frac{R/2}{R} \right) = \frac{g}{2} = 5 \text{ m/s}^2$$

weight = $m \times g$

at depth $R/2 = 20 \times 5 = 100 \text{ N}$

33. A zener diode of power rating 1.6 W is to be used as voltage regulator. If the zener diode has a breakdown of 8V and it has to regulate voltage fluctuating between 3V and 10 V. The value of resistance R_s for safe operation of diode will be :

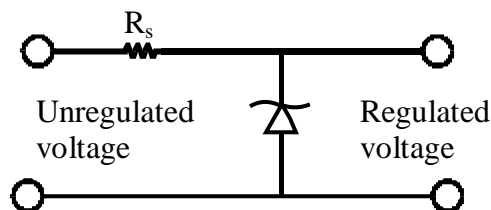

- (1) 13.3Ω (2) 12Ω
 (3) 10Ω (4) 13Ω

Official Ans. by NTA (3)

Sol.

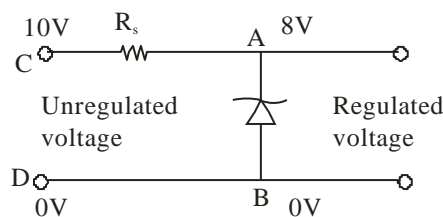

$$V_b = 8 \text{ volt}$$

$$V_A - V_B = 8 \text{ volt}$$

Current through zener diode,

$$i = \frac{P}{V} = \frac{1.6 \text{ W}}{8 \text{ V}} = 0.2 \text{ A}$$

$$V_C - V_A = 10 - 8 \text{ volt}$$

$$\therefore R = \frac{V_C - V_A}{i} = \frac{2 \text{ V}}{0.2 \text{ A}} = 10\Omega$$

[Note : A zener diode can regulate only if input voltage is \geq zener breakdown voltage the range of input voltage should be 8 to 10 V so that output voltage remains constant = 8 V]

34. The range of the projectile projected at an angle of 15° with horizontal is 50 m. If the projectile is projected with same velocity at an angle of 45° with horizontal, then its range will be :
- (1) 50 m (2) $50\sqrt{2}$ m
 (3) 100 m (4) $100\sqrt{2}$ m

Official Ans. by NTA (3)

Sol. For a moving coil galvanometer

$$BiNA = k\theta$$

$$\theta = \left(\frac{BNA}{k} \right) i ; \text{Current sensitive} = \frac{BNA}{k}$$

So, if N is doubled then current sensitivity is doubled.

Voltage sensitivity

$$B \frac{V}{R} NA = k\theta$$

$$V = \frac{BNA}{Rk} \theta, \text{ as N is doubled R is also doubled.}$$

So, no change in voltage sensitivity.

Hence, option (4) is right.

39. Match List I with List II :

List-I		List II	
(A)	3 Translational degrees of freedom	(I)	Monoatomic gases
(B)	3 Translational, 2 rotational degrees of freedoms	(II)	Polyatomic gases
(C)	3 Translational, 2 rotational and 1 vibrational degrees of freedom	(III)	Rigid diatomic gases
(D)	3 Translational, 3 rotational and more than one vibrational degrees of freedom	(IV)	Nonrigid diatomic gases

Choose the correct answer from the options given below :

- (1) (A) – (IV), (B) – (III), (C) – (II), (D) – (I)
- (2) (A) – (IV), (B) – (II), (C) – (I), (D) – (III)
- (3) (A) – (I), (B) – (III), (C) – (IV), (D) – (II)
- (4) (A) – (I), (B) – (IV), (C) – (III), (D) – (II)

Official Ans. by NTA (3)

Sol. Factual

Type of gases	No. of degrees of freedom
Monoatomic gas	3T
Diatomic + rigid	3T + 2R
Diatomic + non-rigid	3T + 2R + 1V
Polyatomic	3T + 3R + More than 1V

T = Translational degree of freedom

R = Rotational degree of freedom

V = Vibrational degree of freedom

40. The equivalent resistance of the circuit shown below between points a and b is :

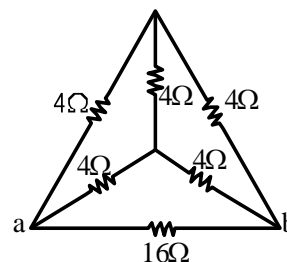

- (1) 24Ω
- (2) 3.2Ω
- (3) 20Ω
- (4) 16Ω

Official Ans. by NTA (2)

Sol. The circuit can be reduced to

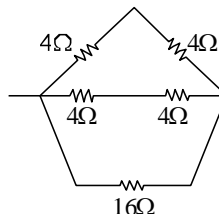

$$\Rightarrow R_{eq} = \frac{16 \times 4}{16 + 4} = \frac{16}{5} \Omega$$

$$= R_{eq} = 3.2\Omega$$

41. Consider two containers A and B containing monoatomic gases at the same Pressure (P), Volume (V) and Temperature (T). The gas in A is compressed isothermally to $\frac{1}{8}$ of its original volume while the gas B is compressed adiabatically to $\frac{1}{8}$ of its original volume. The ratio of final pressure of gas in B to that of gas in A is :

- (1) 8
- (2) $8^{\frac{3}{2}}$
- (3) $\frac{1}{8}$
- (4) 4

Official Ans. by NTA (4)

Sol. Isothermal process, $T = \text{constant}$

$$PV = nRT = \text{constant}$$

$$P_1V_1 = P_2V_2$$

$$PV = P_A(V/8)$$

$$P_A = 8P$$

Adiabatic process, $PV^\gamma = \text{constant}$

γ for monoatomic gas is $\frac{5}{3}$.

$$P_1V_1^\gamma = P_2V_2^\gamma$$

$$\frac{P_B}{P} = \left(\frac{V_1}{V_2}\right)^\gamma = \left(\frac{V}{V/8}\right)^{\frac{5}{3}}$$

$$P_B = 32P$$

$$\frac{P_B}{P_A} = \frac{32P}{8P} = 4$$

42. Given below are two statements:

Statement I : Maximum power is dissipated in a circuit containing an inductor, a capacitor and a resistor connected in series with an AC source, when resonance occurs

Statement II : Maximum power is dissipated in a circuit containing pure resistor due to zero phase difference between current and voltage.

In the light of the above statements, choose the correct answer from the options given below :

- (1) Statement I is false but Statement II is true
- (2) Statement I is true but Statement II is false
- (3) Both Statement I and Statement II are true
- (4) Both Statement I and Statement II are false

Official Ans. by NTA (3)

Sol. Power will be maximum when impedance is minimum

$$Z = [R^2 + (X_L - X_C)^2]^{\frac{1}{2}}$$

At resonance, $X_L = X_C$

$$Z_{\min} = R$$

43. Two satellites of masses m and $3m$ revolve around the earth in circular orbits of radii r & $3r$ respectively. The ratio of orbital speeds of the satellites respectively is :

- (1) 1 : 1
- (2) 3 : 1
- (3) $\sqrt{3}$: 1
- (4) 9 : 1

Official Ans. by NTA (3)

Sol. $v = \sqrt{\frac{GM}{r}}$

$$v \propto \frac{1}{\sqrt{r}} \Rightarrow \frac{v_1}{v_2} = \sqrt{\frac{r_2}{r_1}} = \sqrt{\frac{3r}{r}}$$

$$= \sqrt{3} : 1$$

44. Given below are two statements:

Statement I : Pressure in a reservoir of water is same at all points at the same level of water.

Statement II : The pressure applied to enclosed water is transmitted in all directions equally.

In the light of the above statements, choose the correct answer from the options given below :

- (1) Statement I is false but Statement II is true
- (2) Both Statement I and Statement II are true
- (3) Statement I is true but Statement II is false
- (4) Both Statement I and Statement II are false

Official Ans. by NTA (2)

Sol. Pressure in a static liquid will be same at each point on same horizontal level.

$$\therefore P = P_{\text{atm}} + \rho gh$$

As per Pascal law, same pressure applied to enclosed water is transmitted in all directions equally.

45. The equivalent capacitance of the combination shown is

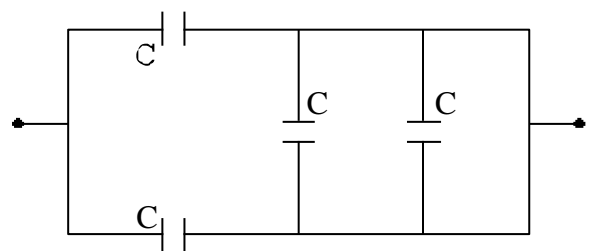

- (1) $\frac{C}{2}$
- (2) $4C$
- (3) $2C$
- (4) $\frac{5}{3}C$

Official Ans. by NTA (3)

Sol. The circuit can be reduced to

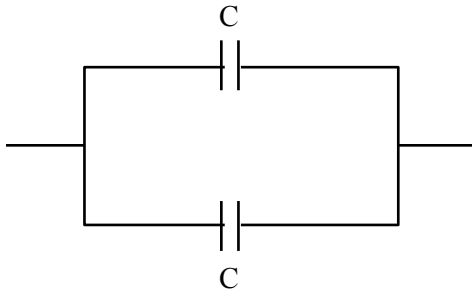

Parallel combination

$$C_{\text{eq}} = C + C = 2C$$

46. The energy of an electromagnetic wave contained in a small volume oscillates with

- (1) zero frequency
- (2) half the frequency of the wave
- (3) double the frequency of the wave
- (4) the frequency of the wave

Official Ans. by NTA (3)

Sol. $E = E_0 \sin(\omega t - kx)$

$$\text{Energy density} \left(\frac{du}{dv} \right) = \epsilon_0 E_0^2 \sin^2(\omega t - kx)$$

$$\frac{\epsilon_0 E_0^2}{2} [1 - \cos(2\omega t - 2kx)]$$

47. An object is placed at a distance of 12 cm in front of a plane mirror. The virtual and erect image is formed by the mirror. Now the mirror is moved by 4 cm towards the stationary object. The distance by which the position of image would be shifted, will be:

- (1) 4 cm towards mirror
- (2) 8 cm towards mirror
- (3) 8 cm away from mirror
- (4) 2 cm towards mirror

Official Ans. by NTA (2)

Sol.

Initial

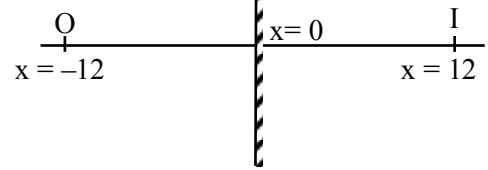

Final

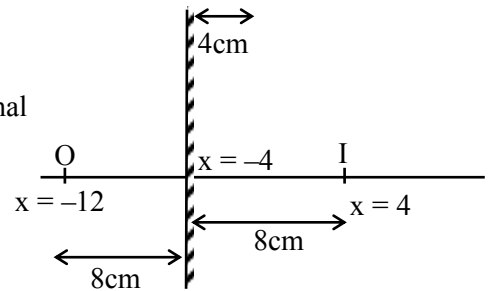

\therefore Shifting of image will be 8 cm towards mirror.

48. The de Broglie wavelength of a molecule in a gas at room temperature (300 K) is λ_1 . If the temperature of the gas is increased to 600 K, then the de Broglie wavelength of the same gas molecule becomes

- (1) $\frac{1}{\sqrt{2}}\lambda_1$
- (2) $2\lambda_1$
- (3) $\frac{1}{2}\lambda_1$
- (4) $\sqrt{2}\lambda_1$

Official Ans. by NTA (1)

Sol. From K.T.G.

$$v_{\text{RMS}} = \sqrt{\frac{3k_B T}{m}}$$

$$v_{\text{RMS}} \propto \sqrt{T}$$

$$\text{and } \frac{h}{mv_{\text{RMS}}} = \lambda \text{ i.e., } \lambda \propto \frac{1}{\sqrt{T}}$$

$$\frac{\lambda_2}{\lambda_1} = \sqrt{\frac{T_1}{T_2}} = \sqrt{\frac{300}{600}} = \frac{1}{\sqrt{2}}$$

$$\lambda_2 = \frac{\lambda_1}{\sqrt{2}}$$

49. A particle executes S.H.M. of amplitude A along x -axis. At $t = 0$, the position of the particle is $x = \frac{A}{2}$ and it moves along positive x -axis the displacement of particle in time t is $x = A \sin(\omega t + \delta)$, then the value δ will be :

- (1) $\frac{\pi}{6}$ (2) $\frac{\pi}{3}$
 (3) $\frac{\pi}{4}$ (4) $\frac{\pi}{2}$

Official Ans. by NTA (1)

- Sol.** $X = A \sin(\omega t + \delta)$ $V = A \omega \cos(\omega t + \delta)$
 $\frac{A}{2} = A \sin(\omega t + \delta)$ $\therefore V$ is +ve, δ must be
 At $t = 0$ in 1st quadrant or 4th
 $\sin \delta = \frac{1}{2} \Rightarrow \delta = \frac{\pi}{6}, \frac{5\pi}{6}$ quadrant
 \therefore Common solution is $\delta = \frac{\pi}{6}$

50. The position-time graphs for two students A and B returning from the school to their homes are shown in figure :

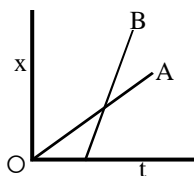

- (A) A lives closer to the school
 (B) B lives closer to the school
 (C) A takes lesser time to reach home
 (D) A travels faster than B
 (E) B travels faster than A

Choose the correct answer from the options given below :

- (1) (A) and (E) only
 (2) (B) and (E) only
 (3) (A), (C) and (E) only
 (4) (A), (C) and (D) only

Official Ans. by NTA (1)

- Sol.** As slope of B > Slope of A
 $\therefore V_B > V_A$
 Also, $t_B < t_A$

SECTION-B

51. Unpolarised light of intensity 32 Wm^{-2} passes through the combination of three polaroids such that the pass axis of the last polaroid is perpendicular to that of the pass axis of first polaroid. If intensity of emerging light is 3 Wm^{-2} , then the angle between pass axis of first two polaroids is _____°.

Official Ans. by NTA (30)

- Sol.** $I_0 = 32 \text{ W/m}^2$

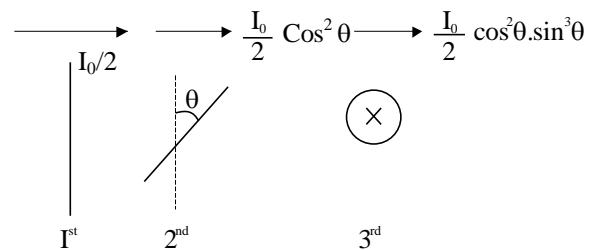

$$I_{\text{net}} = 3 = \frac{32}{2} \cos^2 \theta \cdot \sin^2 \theta$$

$$\frac{3}{4} = 4 \sin^2 \theta \cdot \cos^2 \theta = (\sin 2\theta)^2$$

$$\frac{\sqrt{3}}{2} = \sin(2\theta)$$

Hence, $\theta = 30^\circ$ and 60°

52. A closed circular tube of average radius 15 cm, whose inner walls are rough, is kept in vertical plane. A block of mass 1 kg just fit inside the tube. The speed of block is 22 m/s, when it is introduced at the top of tube. After completing five oscillations, the block stops at the bottom region of tube. The work done by the tube on the block is _____ J. [Given $g = 10 \text{ m/s}^2$]

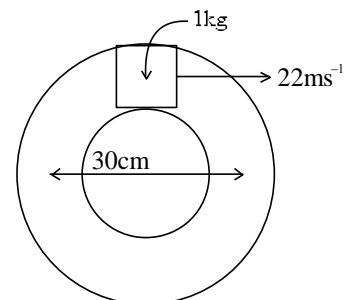

Official Ans. by NTA (+245)

Sol. $r_{\text{avg}} = 15 \text{ cm}$

$$w_f + w_g = \Delta \text{KE}$$

$$w_f + 10 \times 0.3 = -\frac{1}{2} \times 484$$

$$w_f = -245 \text{ J}$$

- 53.** If the earth suddenly shrinks to $\frac{1}{64}$ th of its original volume with its mass remaining the same, the period of rotation of earth becomes $\frac{24}{x}$ h. The value of x is _____.

Official Ans. by NTA (16)

Sol. From conservation of angular momentum

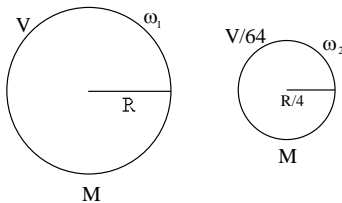

$$\frac{2}{5} MR^2 \omega_1 = \frac{2}{5} M \left(\frac{R}{4}\right)^2 \omega_2$$

$$\Rightarrow MR^2 \omega_1 = \frac{MR^2}{16} \omega_2$$

$$\Rightarrow \frac{\omega_1}{\omega_2} = \frac{1}{16} \Rightarrow \frac{T_2}{T_1} = \frac{1}{16} \Rightarrow \frac{T_1}{T_2} = \frac{16}{1} = \frac{t_1}{x}$$

$$\therefore t_1 = 24 \Rightarrow \frac{16}{1} = \frac{24}{t_2} \Rightarrow x = 16$$

- 54.** The current required to be passed through a solenoid of 15 cm length and 60 turns in order to demagnetise a bar magnet of magnetic intensity $2.4 \times 10^3 \text{ Am}^{-1}$ is _____ A.

Official Ans. by NTA (6)

Sol. $I = H$

Given, $I = 2.4 \times 10^3 \text{ A/m}$

$$2.4 \times 10^3 = H = ni$$

$$n = \frac{N}{\ell}$$

$$2.4 \times 10^3 = \frac{60}{15 \times 10^{-2}} i$$

$$i = \frac{2.4 \times 15 \times 10}{60} = \frac{36}{6} = 6 \text{ A}$$

- 55.** A 1m long metal rod XY completes the circuit as shown in figure. The plane of the circuit is perpendicular to the magnetic field of flux density 0.15 T. If the resistance of the circuit is 5Ω , the force needed to move the rod in direction, as indicated, with a constant speed of 4 m/s will be _____ 10^{-3} N .

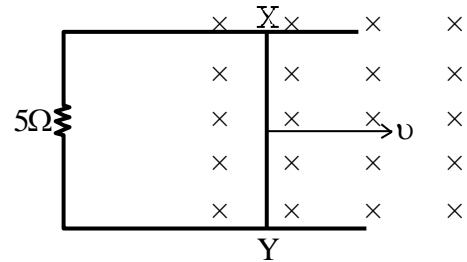

Official Ans. by NTA (18)

Sol. $F = i\ell B$

$$= \left(\frac{\varepsilon}{R}\right) \ell B = \left(\frac{vB\ell}{R}\right) \ell B = \frac{vB^2 \ell^2}{R} = \frac{4}{5} \times \left(\frac{15}{100}\right)^2 \times 1^2$$

$$= \frac{4}{5} \times \frac{225}{10^4}$$

$$= \frac{180}{10^4} = 0.018 \text{ N}$$

$$= 18 \times 10^{-3} \text{ N}$$

- 56.** A transverse harmonic wave on a string is given by $y(x, t) = 5 \sin(6t + 0.003x)$

where x and y are in cm and t in sec. The wave velocity is _____ ms^{-1} .

Official Ans. by NTA (20)

Sol. $y(x, t) = 5 \sin(6t + 0.003x)$

$$k = 0.003 \text{ cm}^{-1}, \quad \omega = 6 \text{ rad/s}, \quad v = \frac{\omega}{k}$$

$$\Rightarrow \frac{6}{0.003 \times 10^2} = 20 \text{ ms}^{-1}$$

57. The decay constant for a radioactive nuclide is $1.5 \times 10^{-5} \text{ s}^{-1}$. Atomic of the substance is 60 g mole^{-1} , ($N_A = 6 \times 10^{23}$). The activity of 1.0 μg of the substance is _____ $\times 10^{10} \text{ Bq}$.

Official Ans. by NTA (15)

Sol. $\lambda = 1.5 \times 10^{-5} \text{ s}^{-1}$

$$\text{No. of mole} = \frac{1 \times 10^{-6}}{60} = \frac{10^{-7}}{6}$$

$$\text{No. of atoms} = \text{no. of moles} \times N_A$$

$$= \frac{10^{-7}}{6} \times 6 \times 10^{23} = 10^{16}$$

$$A = N_0 \lambda e^{-\lambda t}$$

$$\text{For, } t = 0, A = A_0 = N_0 \lambda$$

$$= 1.5 \times 10^{-5} \times 10^{16} = 15 \times 10^{10} \text{ Bq.}$$

58. Three concentric spherical metallic shells X, Y and Z of radius a, b and c respectively [$a < b < c$] have surface charge densities $\sigma, -\sigma$ and σ , respectively. The shells X and Z are at same potential. If the radii of X & Y are 2 cm and 3 cm, respectively. The radius of shell Z is _____ cm.

Official Ans. by NTA (5)

Sol.

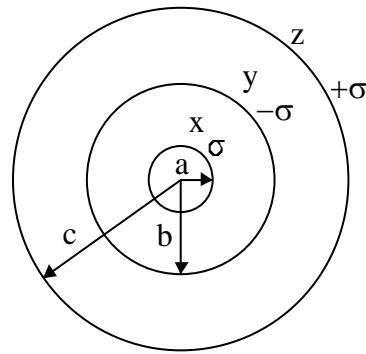

$$q_x = \sigma 4\pi a^2$$

$$q_y = -\sigma 4\pi b^2$$

$$q_z = \sigma 4\pi c^2$$

Potential x = potential z

$$V_x = V_z$$

$$\frac{q_x}{4\pi\epsilon_0 a} + \frac{q_y}{4\pi\epsilon_0 b} + \frac{q_z}{4\pi\epsilon_0 c} = \frac{q_x}{4\pi\epsilon_0 c} + \frac{q_y}{4\pi\epsilon_0 c} + \frac{q_z}{4\pi\epsilon_0 c}$$

$$\frac{\sigma 4\pi a^2}{a} - \frac{\sigma 4\pi b^2}{b} + \frac{\sigma 4\pi c^2}{c} = \frac{4\pi\sigma[a^2 - b^2 + c^2]}{c}$$

$$c(a - b + c) = a^2 - b^2 + c^2$$

$$c(a - b) = a^2 - b^2$$

$$c = a + b$$

$$c = 5 \text{ cm}$$

59. 10 resistors each of resistance 10Ω can be connected in such as to get maximum and minimum equivalent resistance. The ratio of maximum and minimum equivalent resistance will be _____.

Official Ans. by NTA (100)

Sol. Maximum resistance occurs

When all the resistors are connected in series combination

$$\therefore R_{\max} = 10 R$$

Here $R = 10 \text{ ohm}$

Minimum resistance occurs

When all the resistance are connected in parallel combination

$$R_{\min} = \frac{R}{10}$$

$$\therefore \frac{R_{\max}}{R_{\min}} = 100$$

60. Two wires each of radius 0.2 cm and negligible mass, one made of steel and other made of brass are loaded as shown in the figure. The elongation of the steel wire is _____ $\times 10^{-6}$ m. [Young's modulus for steel = $2 \times 10^{11} \text{ Nm}^{-2}$ and $g = 10 \text{ ms}^{-2}$]

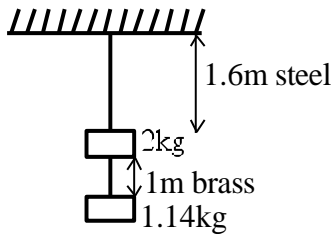

Official Ans. by NTA (20)

Sol. Tension in steel wire $T_2 = 2g + T_1$
 $T_2 = 20 + 11.4$
 $= 31.4 \text{ N}$

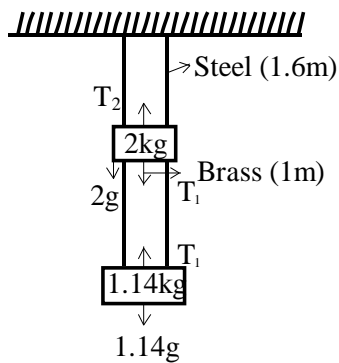

Elongation in steel wire $\Delta L = \frac{T_2 L}{A y}$

$$\Delta L = \frac{31.4 \times 1.6}{\pi (0.2 \times 10^{-2})^2 \times 2 \times 10^{11}}$$

$$\Delta L = \frac{16}{2 \times 4 \times 10^{-6} \times 10^{11}}$$

$$= 2 \times 10^{-5} \text{ m}$$

$$= 20 \times 10^{-6} \text{ m}$$

CHEMISTRY

TEST PAPER WITH SOLUTIONS

SECTION-A

- 61.** Using column chromatography, mixture of two compounds 'A' and 'B' was separated. 'A' eluted first, this indicates 'B' has
- (1) low R_f , weaker adsorption
 - (2) high R_f , stronger adsorption
 - (3) high R_f , weaker adsorption
 - (4) low R_f , stronger adsorption
- Official Ans. by NTA (4)**

Sol. If any component eluted second then it means that its R_f value is low and its adsorption is stronger

$$R_f = \frac{\text{distance covered by substance from base line}}{\text{total distance covered by solvent from base line}}$$

- 62.** Prolonged heating is avoided during the preparation of ferrous ammonium sulphate to
- (1) prevent oxidation
 - (2) prevent reduction
 - (3) prevent hydrolysis
 - (4) prevent breaking
- Official Ans. by NTA (1)**

Sol. Prolonged heating will cause oxidation of Fe^{+2} to Fe^{+3} .

- 63.** Lime reacts exothermally with water to give 'A' which has low solubility in water. Aqueous solution of 'A' is often used for the test of CO_2 , a test in which insoluble B is formed. If B is further reacted with CO_2 then soluble compound is formed 'A' is
- (1) Quick lime
 - (2) Slaked lime
 - (3) Lime water
 - (4) White lime
- Official Ans. by NTA (2)**

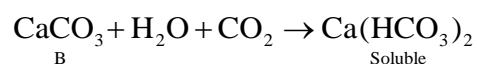
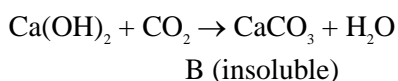
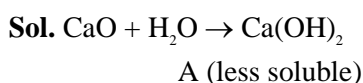

- 64.** The pair from the following pairs having both compounds with net non-zero dipole moment is
- (1) Benzene, anisidine
 - (2) 1,4-Dichlorobenzene, 1,3-Dichlorobenzene
 - (3) CH_2Cl_2 , CHCl_3
 - (4) cis-butene, trans-butene
- Official Ans. by NTA (3)**

Sol. (1) Benzene \rightarrow non polar

Anisidine \rightarrow polar

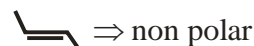
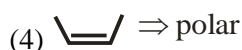
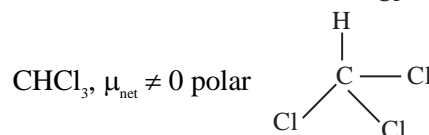
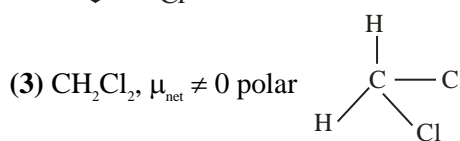
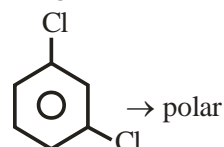
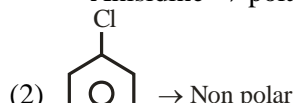

- 65.** Match List-I with List-II

List-I

Industry

- (A) Steel plants
- (B) Thermal power plants
- (C) Fertilizer industries
- (D) Paper mills

List-II

Waste Generated

- (I) Gypsum
- (II) Fly ash
- (III) Slag
- (IV) Bio-degradable Wastes

Choose the correct answer from the options given below:

- (1) (A)-(III), (B)-(II), (C)-(I), (D)-(IV)
- (2) (A)-(II), (B)-(III), (C)-(IV), (D)-(I)
- (3) (A)-(IV), (B)-(I), (C)-(II), (D)-(III)
- (4) (A)-(III), (B)-(IV), (C)-(I), (D)-(II)

Official Ans. by NTA (1)

Sol. Steel plant produces slag from blast furnace. Thermal power plant produces fly ash, Fertilizer industries produces gypsum. Paper mills produces bio degradable waste

66. Isomeric amines with molecular formula $C_8H_{11}N$ give the following tests

Isomer (P) \Rightarrow Can be prepared by Gabriel phthalimide synthesis

Isomer (Q) \Rightarrow Reacts with Hinsberg's reagent to give solid insoluble in NaOH

Isomer (R) \Rightarrow Reacts with HONO followed by β -naphthol in NaOH to give red dye.

Isomers (P), (Q) and (R) respectively are

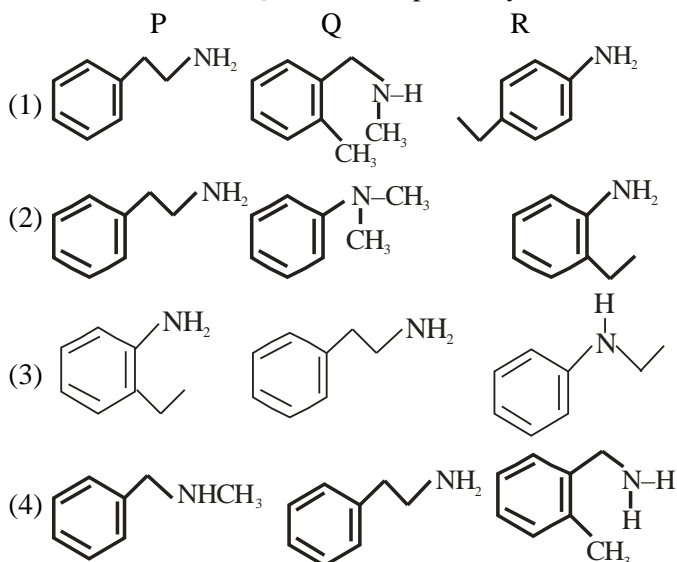

Official Ans. by NTA (1)

Sol. (P) Gabriel phthalimide synthesis is used for the preparation of aliphatic primary amines. Aromatic primary amines cannot be prepared by this method.

(Q) 2° -amines reacts with Hinsberg's reagent to give solid insoluble in NaOH

(R) Aromatic primary amine react with nitrous acid at low temperature (273 – 298 K) to form diazonium salts, which form Red dye with β -Naphthol

67. Given below are two statements

Statement I : Aqueous solution of $K_2Cr_2O_7$ is preferred as a primary standard in volumetric analysis over $Na_2Cr_2O_7$ aqueous solution

Statement II : $K_2Cr_2O_7$ has a higher solubility in water than $Na_2Cr_2O_7$

In the light of the above statements, choose the correct answer from the options given below:

- (1) Both Statement I and Statement II are true
- (2) Both Statement I and Statement II are false
- (3) Both Statement I is true but Statement II is false
- (4) Both Statement I is false but Statement II is true

Official Ans. by NTA (3)

Sol. (1) $K_2Cr_2O_7$ is used as primary standard. The concentration $Na_2Cr_2O_7$ changes in aq. solution.

(2) It is less soluble than $Na_2Cr_2O_7$.

68. The one that does not stabilize 2° and 3° structures of proteins is

- (1) H-bonding
- (2) -S-S-linkage
- (3) -O-O-linkage
- (4) van der Waals forces

Official Ans. by NTA (3)

Sol. 2° and 3° structure of proteins are stabilized by hydrogen bonding, disulphide linkages, Van der Waals force of attraction and electrostatic force of attraction.

69. Given below are two reactions, involved in the commercial production of dihydrogen (H_2).

The two reactions are carried out at temperature " T_1 " and " T_2 " respectively

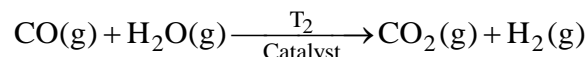
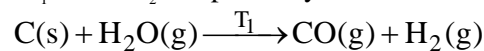

The temperature T_1 and T_2 are correctly related as

- (1) $T_1 > T_2$
- (2) $T_1 = T_2$
- (3) $T_1 = 100 \text{ K}, T_2 = 1270 \text{ K}$
- (4) $T_1 < T_2$

Official Ans. by NTA (1)

Sol. $T_1 = 1270 \text{ K}$ $T_2 = 673 \text{ K}$

$T_1 > T_2$ on the basis of data

70. Which of the following statements are correct?

- (A) The M^{3+}/M^{2+} reduction potential for iron is greater than manganese
- (B) The higher oxidation states of first row d-block elements get stabilized by oxide ion.
- (C) Aqueous solution of Cr^{2+} can liberate hydrogen from dilute acid.
- (D) Magnetic moment of V^{2+} is observed between 4.4-5.2 BM

Choose the correct answer from the options given below:

- (1) (B), (C) only
- (2) (A), (B), (D) only
- (3) (C), (D) only
- (4) (A), (B) only

Official Ans. by NTA (1)

Sol. (A) The M^{3+}/M^{2+} reduction potential for manganese is greater than iron

(B) $E^0_{Fe^{+3}/Fe^{+2}} = +0.77$

$E^0_{Mn^{+3}/Mn^{+2}} = +1.57$

(C) $E^0_{Cr^{+3}/Cr^{+2}} = -0.26$

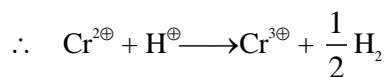

(D) $V^{2\oplus} = 3$ unpaired electron

Magnetic Moment = 3.87 B.M

71. Which of the following is used as a stabilizer during the concentration of sulphide ores?

- (1) Pine oils
- (2) Xanthates
- (3) Fatty acids
- (4) Cresols

Official Ans. by NTA (4)

Sol. Cresol is used as stabilizer.

72. The octahedral diamagnetic low spin complex among the following is

- (1) $[NiCl_4]^{2-}$
- (2) $[CoCl_6]^{3-}$
- (3) $[CoF_6]^{3-}$
- (4) $[Co(NH_3)_6]^{3+}$

Official Ans. by NTA (4)

Sol. (1) Paramagnetic, High Spin & Tetrahedral

- (2) Paramagnetic, High Spin & Octahedral
- (3) Paramagnetic, High Spin & Octahedral
- (4) Diamagnetic, Low Spin & Octahedral



$NH_3 = SFL$

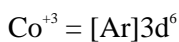

Diamagnetic & Low spin complex

73. Given

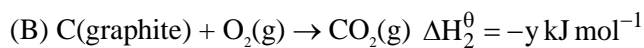
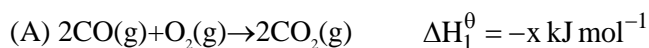

The ΔH^0 for the reaction

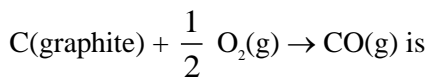

(1) $\frac{x-2y}{2}$ (3) $\frac{x+2y}{2}$

(3) $\frac{2x-y}{2}$ (4) $2y-x$

Official Ans. by NTA (1)

Sol. Target equation

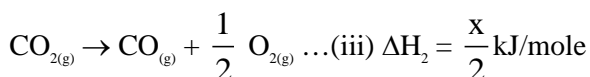
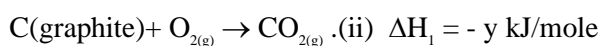
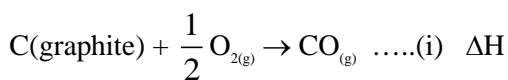

eq. (i) = eq.(ii) + eq (iii)

$\therefore \Delta H = \frac{x}{2} - y = \frac{x-2y}{2}$

74. The compound which does not exist is

- (1) NaO_2
- (2) $(NH_4)_2BeF_4$
- (3) BeH_2
- (4) $PbEt_4$

Official Ans. by NTA (1)

Sol. Sodium superoxide is not stable

75. Match List I with List II

List-I

List-II

Polymer

Type/Class

- | | |
|-----------------------|------------------------------|
| (A) Nylon-2-Nylon-6 | (I) Thermosetting Polymer |
| (B) Buna-N | (II) Biodegradable polymer |
| (C) Urea-formaldehyde | (III) Synthetic rubber resin |
| (D) Dacron | (IV) Polyester |

Choose the correct answer from the options given below:

- (1) (A)-(IV), (B)-(I), (C)-(III), (D)-(II)
- (2) (A)-(IV), (B)-(III), (C)-(I), (D)-(II)
- (3) (A)-(II), (B)-(I), (C)-(IV), (D)-(III)
- (4) (A)-(II), (B)-(III), (C)-(I), (D)-(IV)

Official Ans. by NTA (4)

Sol.

- (A) Nylon-2-nylon-6
Biodegradable polymer and polyamides (II)
- (B) Buna-N \rightarrow Butadiene acrylonitrile rubber \rightarrow
synthetic rubber (III)
- (C) Urea-formaldehyde resin \rightarrow Thermosetting
polymer (I)
- (D) Dacron \rightarrow Polyester polymer of ethylene
glycol and terephthalic acid (IV)

76. The number of molecules and moles in 2.8375 litres of O_2 at STP are respectively

- (1) 7.527×10^{22} and 0.250 mol
(2) 1.505×10^{23} and 0.250 mol
(3) 7.527×10^{23} and 0.125 mol
(4) 7.527×10^{22} and 0.125 mol

Official Ans. by NTA (4)

Sol. Number of moles of $O_2 = \frac{2.8375}{22.7} = 0.125$

\Rightarrow Number of molecules = $0.125 N_A$
 $= 7.525 \times 10^{22}$

77. The enthalpy change for the adsorption process and micelle formation respectively are

- (1) $\Delta H_{ads} < 0$ and $\Delta H_{mic} > 0$
(2) $\Delta H_{ads} < 0$ and $\Delta H_{mic} < 0$
(3) $\Delta H_{ads} > 0$ and $\Delta H_{mic} < 0$
(4) $\Delta H_{ads} > 0$ and $\Delta H_{mic} > 0$

Official Ans. by NTA (1)

Sol. Adsorption is exothermic process due to decrease in surface energy

Micelle formation is endothermic

78. The major product 'P' formed in the given reaction is

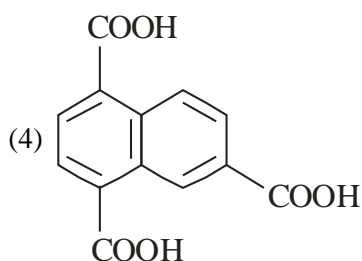
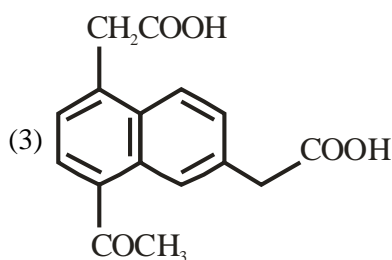
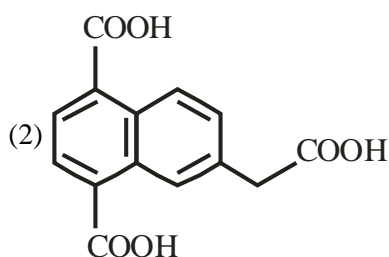
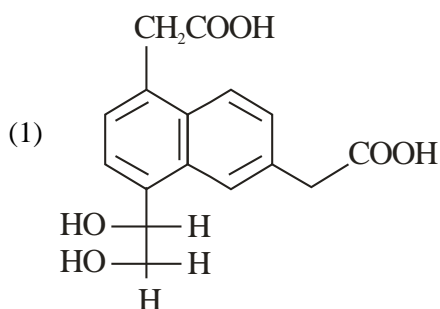
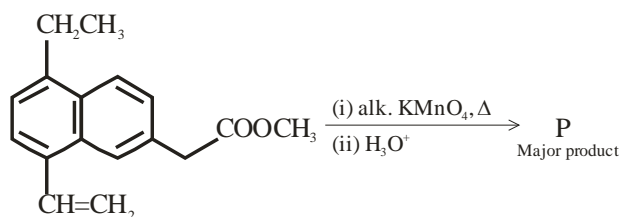

Official Ans. by NTA (4)

Sol.

$KMnO_4$ oxidises benzylic carbon containing atleast one α -hydrogen atom to $-COOH$.

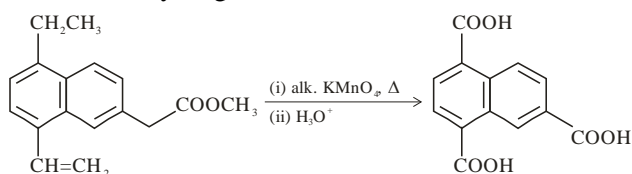

79. Suitable reaction condition for preparation of Methyl phenyl ether is

- (1) $\text{Ph}-\text{Br}, \text{MeO}^-\text{Na}^+$
- (2) $\text{PhO}^-\text{Na}^+, \text{MeOH}$
- (3) $\text{PhO}^-\text{Na}^+, \text{MeBr}$
- (4) Benzene, MeBr

Official Ans. by NTA (3)

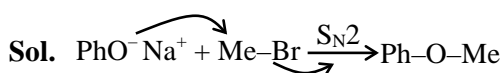

80. Identify the correct order of reactivity for the following pairs towards the respective mechanism

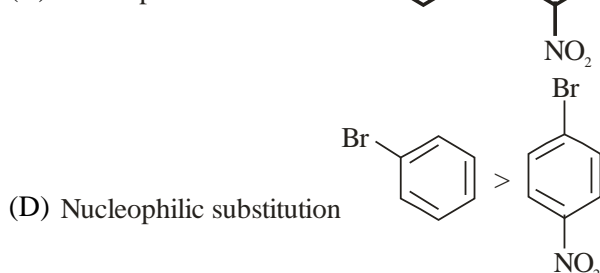
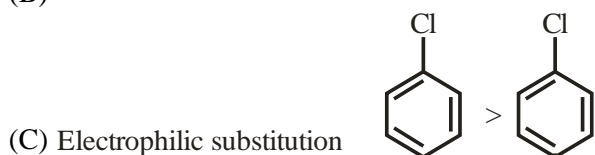
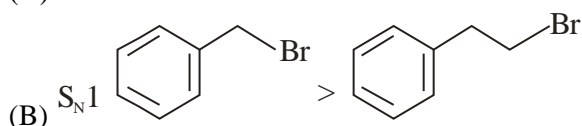
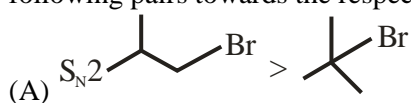

Choose the correct answer from the options given below :

- (1) (A), (B) and (D) only
- (2) (A), (B), (C) and (D)
- (3) (A), (C) and (D) only
- (4) (B), (C) and (D) only

Official Ans. by NTA (2)

Sol.

All are correct

- (A) $\text{S}_{\text{N}}2$ reaction decreases with increase in steric crowding.
- (B) $\text{S}_{\text{N}}1$ reaction increases with stability of carbocation.
- (C) EAS reaction decreases with decrease in electron density.
- (D) Presence of electron withdrawing group at ortho and para-position to a halogen in haloarene increase nucleophilic aryl substitution.

SECTION-B

81. The number of correct statement/s involving equilibria in physical process from the following is

- (A) Equilibrium is possible only in a closed system at a given temperature
- (B) Both the opposing processes occur at the same rate.
- (C) When equilibrium is attained at a given temperature, the value of all its parameters became equal
- (D) For dissolution of solids in liquids, the solubility is constant at a given temperature

Official Ans. by NTA (3)

Sol. (A) is correct

(B) for equilibrium $r_f = r_b$

\Rightarrow (B) is correct

(C) at equilibrium the value of parameters become constant of a given temperature and not equal

\Rightarrow (C) is incorrect

(D) for a given solid solute and a liquid solvent solubility depends upon temperature only

\Rightarrow (D) is correct

82. The number of bent-shaped molecule/s from the following is _____

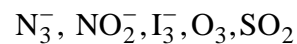

Official Ans. by NTA (3)

Sol. N_3^- linear

NO_2^- bent

I_3^- linear

O_3 bent

SO_2 bent

83. A molecule undergoes two independent first order reactions whose respective half lives are 12 min and 3 min. If both the reactions are occurring then the time taken for the 50% consumption of the reactant is _____ min. (Nearest integer)

Official Ans. by NTA (2)

$$\text{Sol. } \frac{1}{t_{1/2}} = \frac{1}{3} + \frac{1}{12} = \frac{4+1}{12} = \frac{5}{12}$$

$$t_{1/2} = \frac{12}{5} \text{ min} = 2.4$$

Ans. is 2

84. The number of incorrect statement/s about the black body from the following is _____

- (A) Emit or absorb energy in the form of electromagnetic radiation
 (B) Frequency distribution of the emitted radiation depends on temperature
 (C) At a given temperature, intensity vs frequency curve passes through a maximum value
 (D) The maximum of the intensity vs frequency curve is at a higher frequency at higher temperature compared to that at lower temperature

Official Ans. by NTA (0)

Sol. A blackbody can emit and absorb all the wavelengths in electromagnetic spectrum \Rightarrow (A) is correct

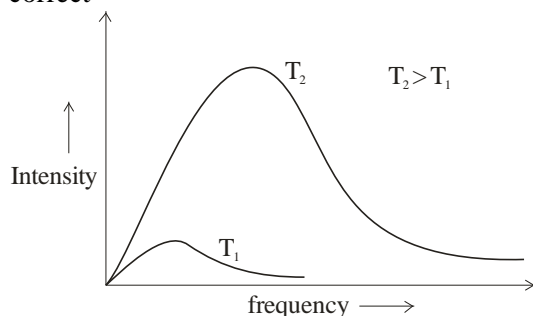

\Rightarrow (B), (C), (D) correct

Ans (0)

85. In the following reactions, the total number of oxygen atoms in X and Y is _____

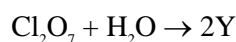

Official Ans. by NTA (5)

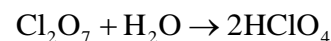
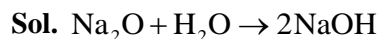

$$1 + 4 = 5$$

86. $\text{FeO}_4^{2-} \xrightarrow{+2.2\text{V}} \text{Fe}^{3+} \xrightarrow{+0.70\text{V}} \text{Fe}^{2+} \xrightarrow{-0.45\text{V}} \text{Fe}^0$

$E_{\text{FeO}_4^{2-}/\text{Fe}^{2+}}^0$ is $x \times 10^{-3}$ V. The value of x is _____

Official Ans. by NTA (1825)

Sol.

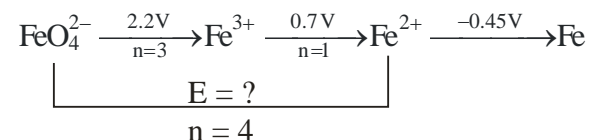

$$4 \times E = 3 \times 2.2 + 1 \times 0.7$$

$$E = \frac{7.3}{4} = 1.825 \text{ V} = 1825 \times 10^{-3} \text{ V}$$

87. If the degree of dissociation of aqueous solution of weak monobasic acid is determined to be 0.3, then the observed freezing point will be _____ % higher than the expected/theoretical freezing point. (Nearest integer)

Official Ans. by NTA (30)

$$\text{Sol. } i = 1 + \alpha \text{ (for HA)}$$

$$= 1.3$$

$$\% \text{ increase} = \frac{(\Delta T_f)_{\text{obs}} - (\Delta T_f)_{\text{cal}}}{(\Delta T_f)_{\text{cal}}} \times 100$$

$$= \frac{K_f \times i \times m - K_f \times m}{K_f \times m} \times 100$$

$$= \frac{i-1}{1} \times 100 = 30\%$$

88. In potassium ferrocyanide, there are ____ pairs of electrons in the t_{2g} set of orbitals

Official Ans. by NTA (3)

Sol. $K_4[Fe(CN)_6]$

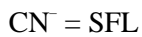
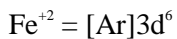
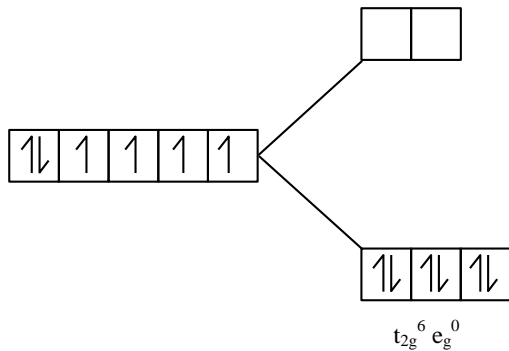

t_{2g} contain 6 electron so it become 3 pairs:-

89. At constant temperature a gas is at a pressure of 940.3 mm Hg. The pressure at which its volume decreases by 40% is _____ mm Hg.

(Nearest Integer)

Official Ans. by NTA (1567)



$$940.3 \times 100 = P_2 \times 60$$

$$P_2 = 1567 \text{ mm of Hg}$$

90. The sum of lone pairs present on the central atom of the interhalogen IF_5 and IF_7 is _____

Official Ans. by NTA (1)

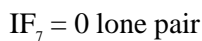
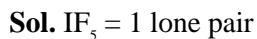

$$1 + 0 = 1$$

