

**Common Entrance Examination for Design**

**CEED 2022**

**Question Paper**

## Part A – Section I: Numerical Answer Type Questions

- Q.01** Solid 1, Solid 2 and Solid 3 are joined together to form a cuboid as shown in Figure 1. The cuboid is then painted from all the sides. How many surfaces are there without the paint when you separate all the three solids?

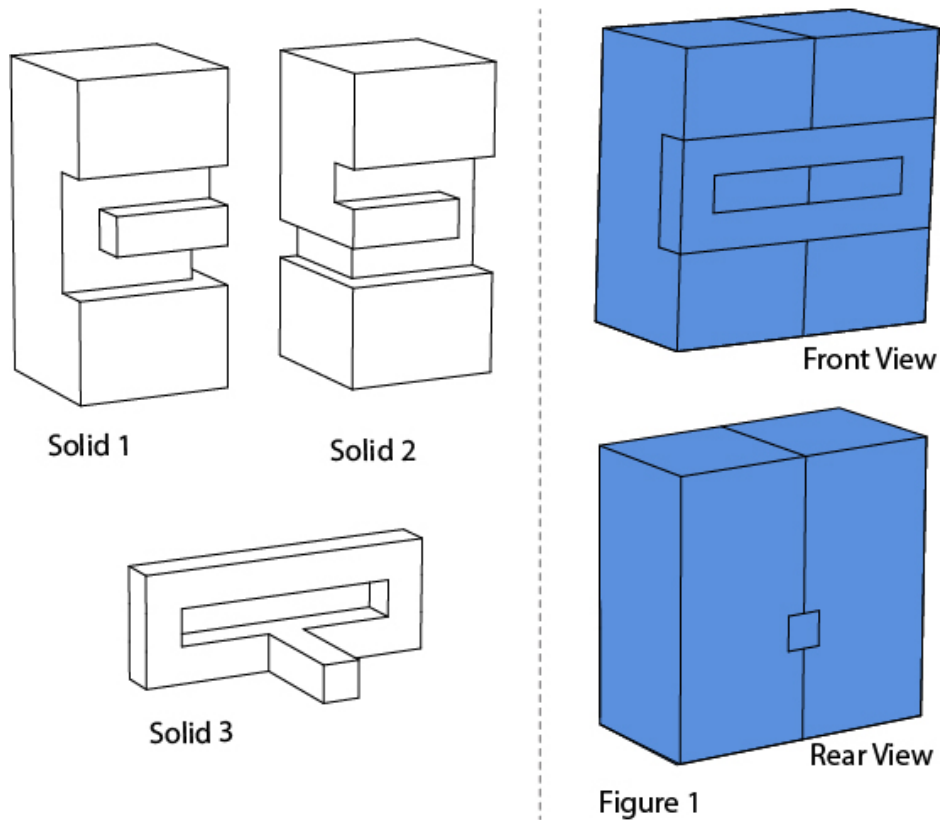

- Q.02** An irregular solid is cut into seven pieces as shown. The pieces are neither rotated nor scaled, but are kept in a random sequence. Find the correct sequence to get the smooth form. The sequence should be written from left to right.

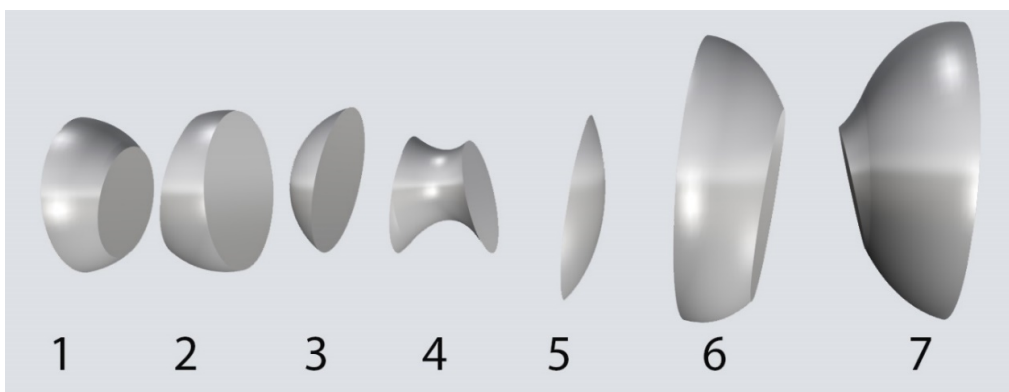

**Q.03** What are the least number of lines required to generate a 3D form such that it creates shadows similar to the figure shown below?

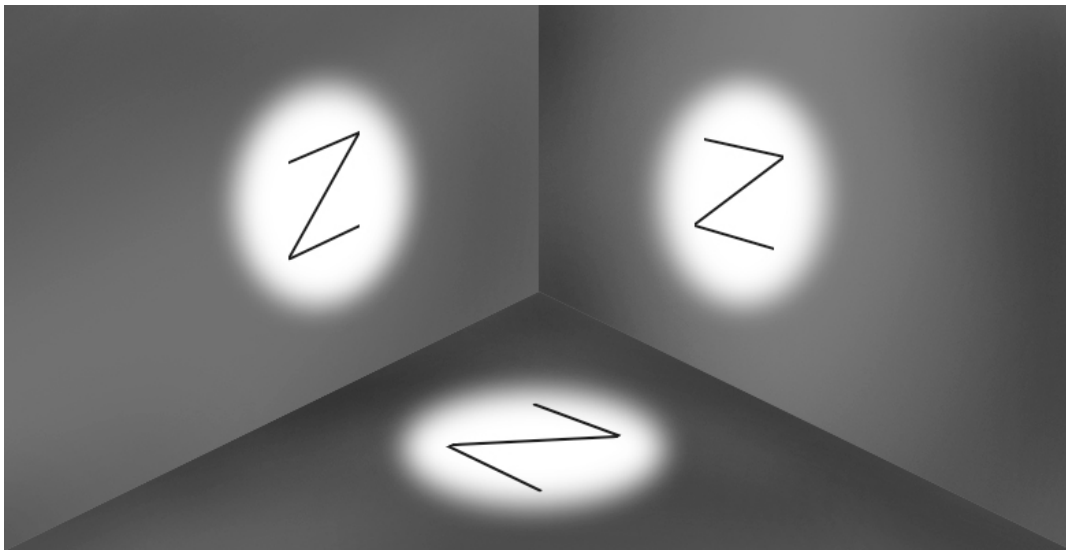

**Q.04** In the square ABCD, line XY is drawn parallel to the base as shown in the figure below. P and Q are any two arbitrary points on XY, forming triangles ABQ and CDP. What fraction of the area of the square is the total green shaded area?

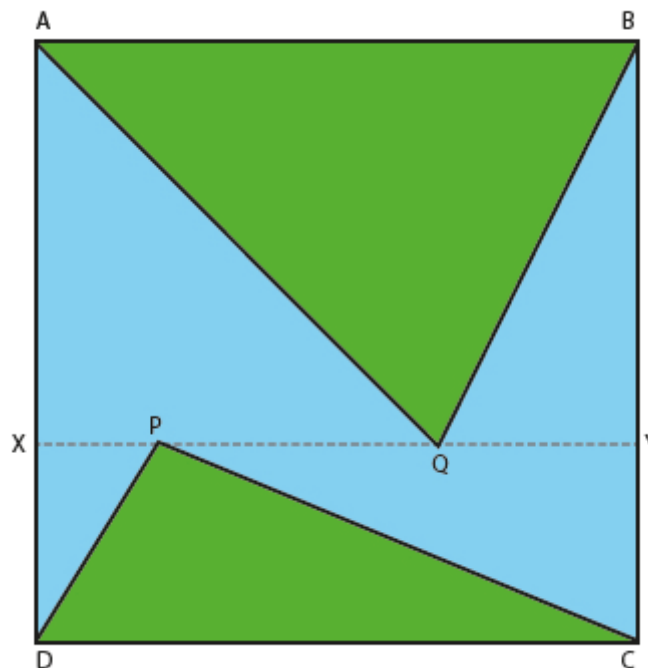

- Q.05** Five square pyramids are stacked as shown in the figure below with the bottom layer consisting of four pyramids in a 2 x 2 grid. If the bottom layer consists of pyramids in 6 x 7 grid, and they are stacked in a similar manner to its maximum height, how many pyramids will the formation contain?

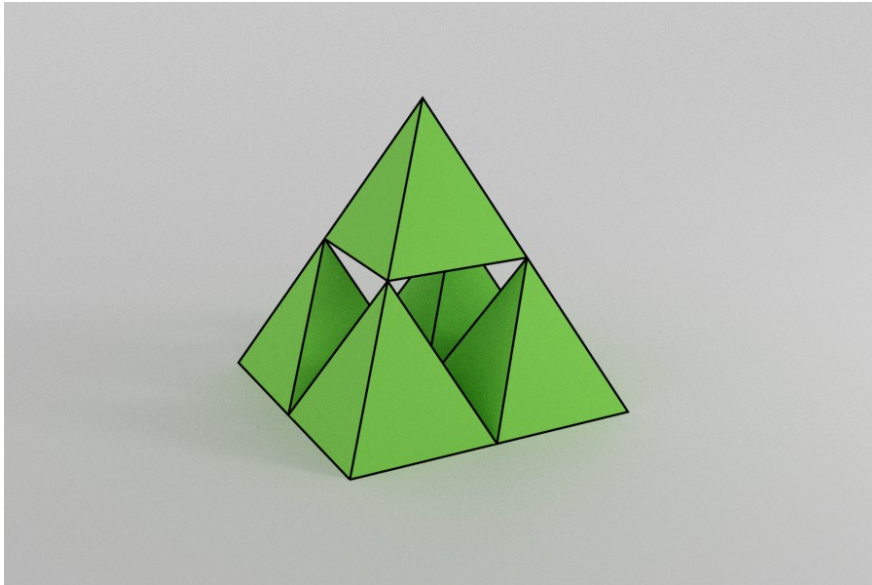

- Q.06** A bank needs to upgrade its ATM kiosks to be wheel-chair accessible. An ATM kiosk entrance has four steps rising up to reach the floor level of the kiosk. Each step is 1000 mm in length, 300 mm in breadth, and 150 mm in height. The bank proposes to create a wheel-chair accessible ramp with a slope of 1:12, adjacent to the steps. What is the minimum horizontal length of the ramp in metre?

**Q.07** A system of frictionless and massless pulleys is being used to pull up a load of 2520 N. What is the minimum force (in Newtons) required at the end of the rope (shown in dashed lines)?

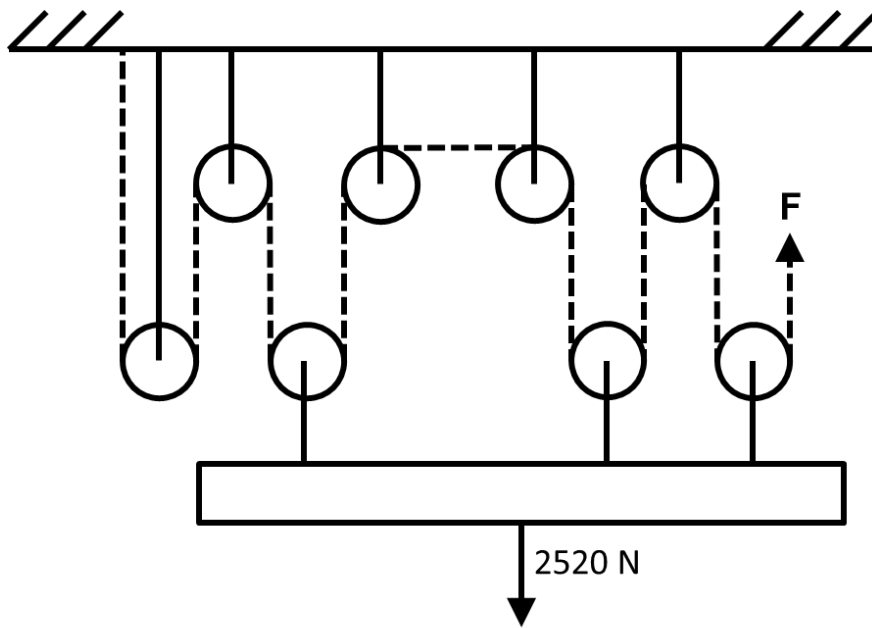

**Q.08** Shown below are three views of the same solid. Count the number of edges.

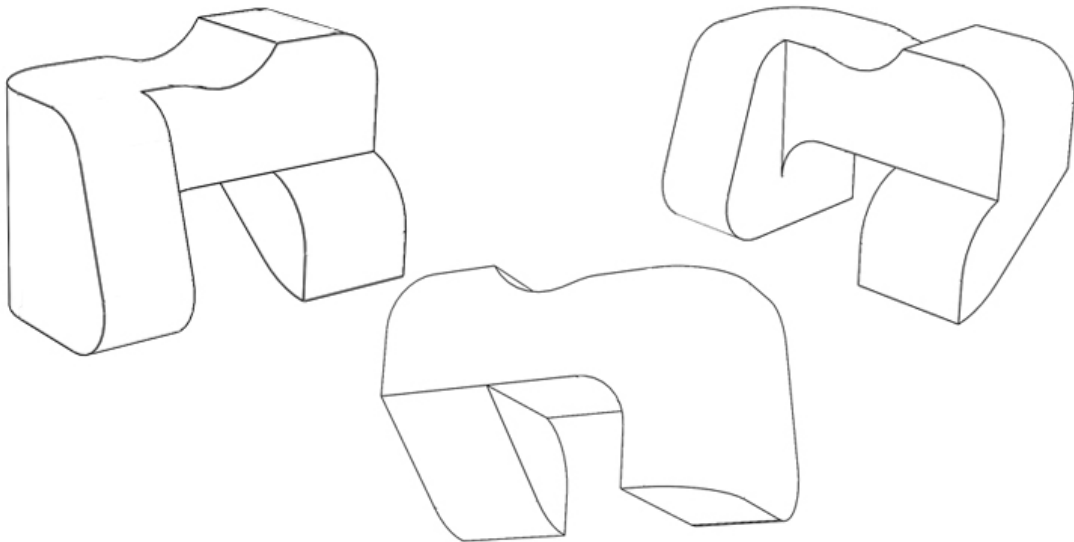

## Part A – Section II: Multiple Select Questions

**Q.09** A virus has two variants P and Q. Two treatments L and M were developed against variant P and Q and tested through four independent trials. The table shows the results. Assuming that both variants are equally prevalent, and both treatments cost about the same, but a given patient can be treated with only one treatment, which of the options is/are true?

	Against variant P	Against variant Q	Total
Treatment L	44 successes / 50	81 successes / 100	125 successes / 150
Treatment M	94 successes / 100	31 successes / 50	125 successes / 150

- A. If the patient is known to be infected by variant P, both the treatments will be equally effective
- B. If we can determine that the patient is infected by variant Q, treatment L has a higher chance of success
- C. If the variant that the patient is infected by is not known, then both the treatments can be equally effective
- D. If a hospital can stock only one of the two treatments, they should stock treatment L

**Q.10** Figure shows the plan of a one-way road passing next to a primary school. Which of the options can be the location(s) to set up a bus stop for the school bus in Indian context?

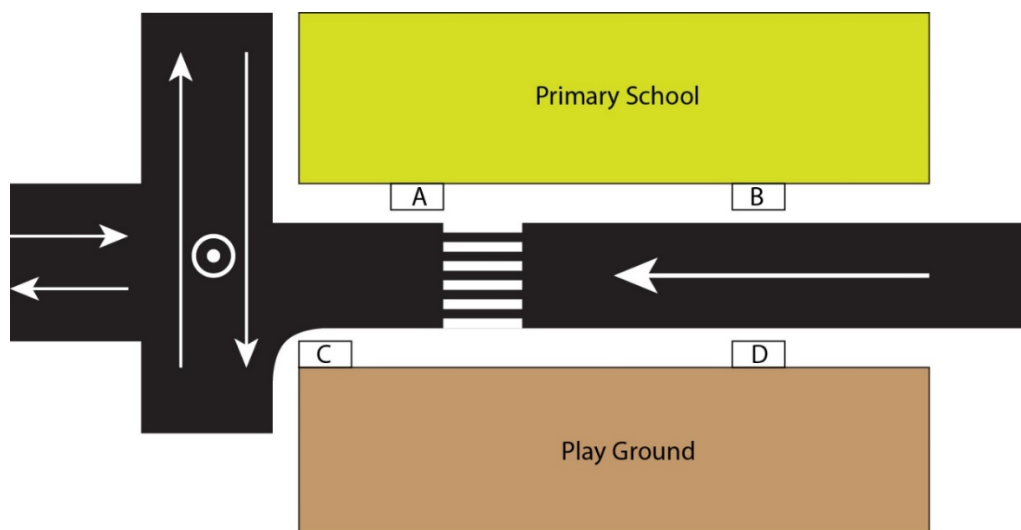

**Q.11** Mobile sculptures are created by tying fish-shaped cut-outs of different colours using blue strings on brown sticks of negligible weight, as shown below. All the fish cut-outs are of the same size and weight. Which of the options will remain balanced after suspending from a ceiling?

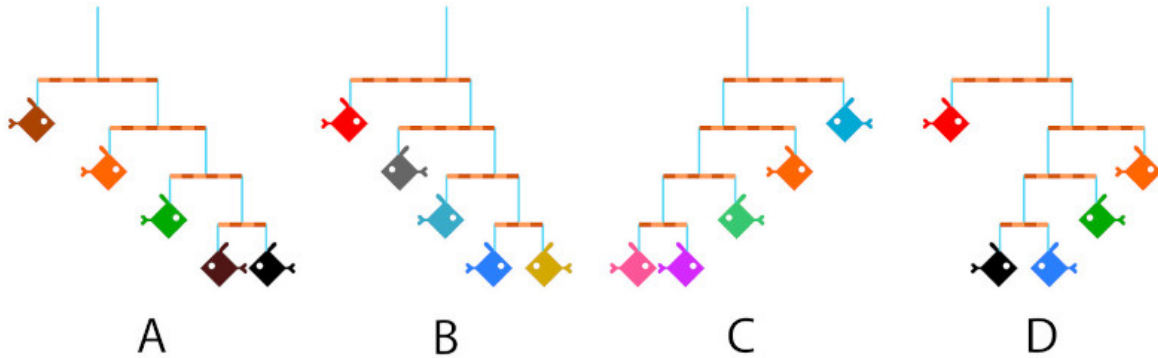

**Q.12** Which of the graphs shown below represent(s) the equation  $XY = 25$ ?

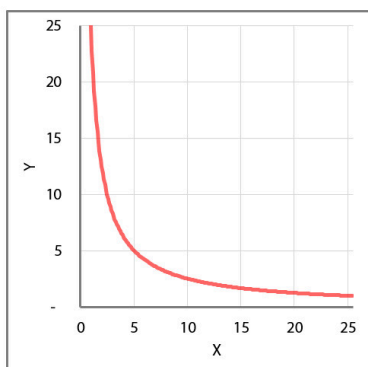

A

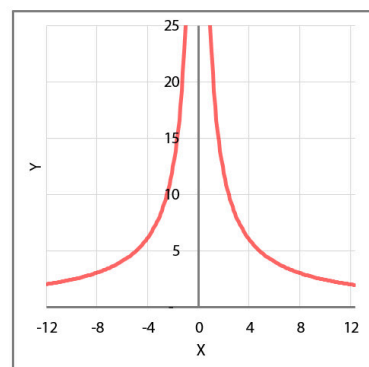

B

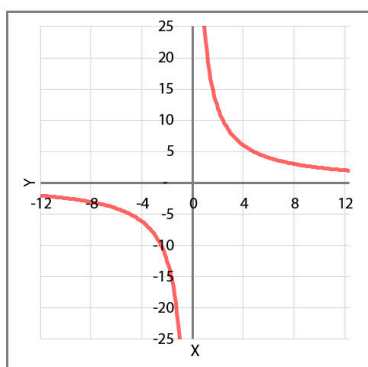

C

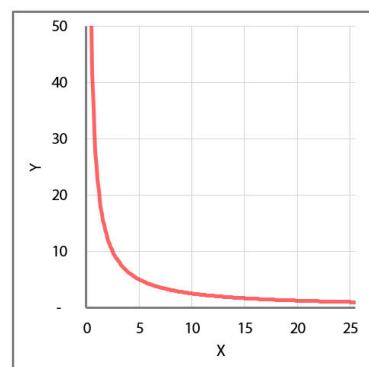

D

**Q.13** Which of the following rocking chairs will **NOT** topple while rocking 15 degree?

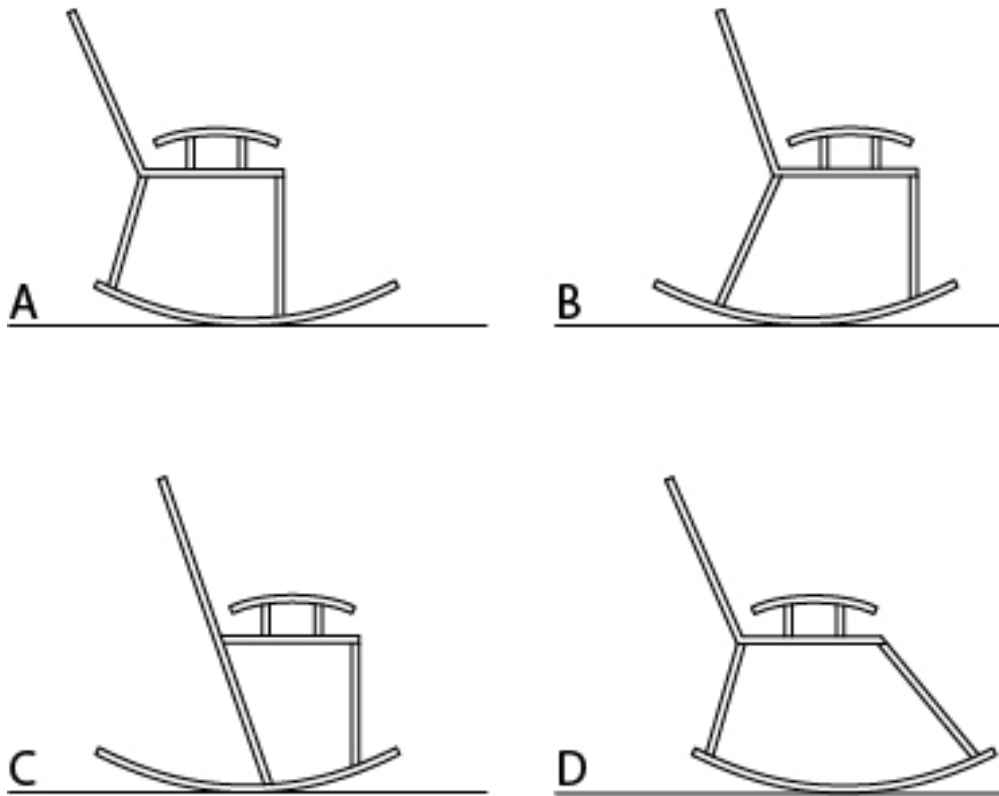

**Q.14** Shown on the left are the front and top views of a 3D object. Which option(s) can be the side view?

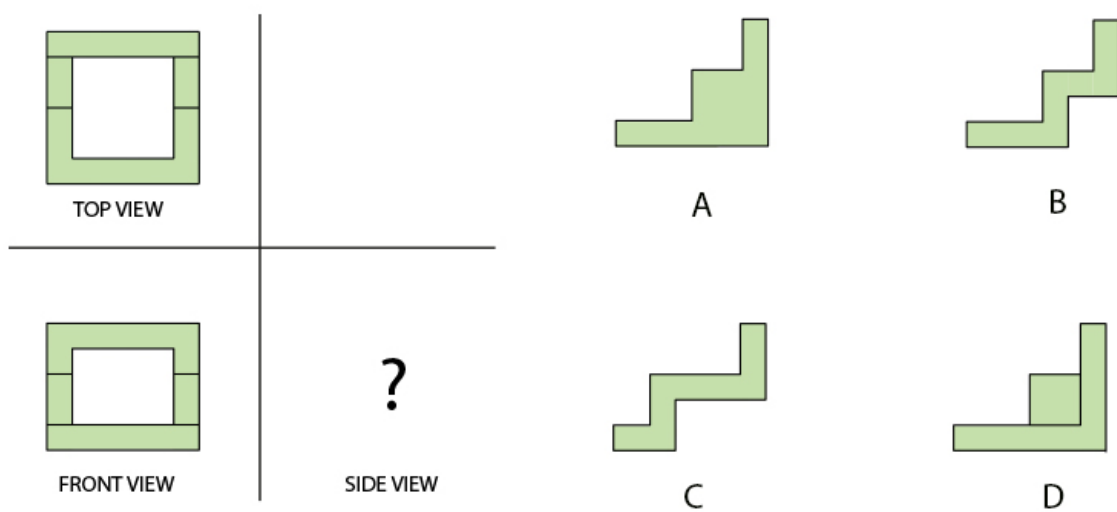



**Q.15** Figure P can be divided into four identical pieces. Assuming that the pieces can be rotated and flipped, which of the options will fit?

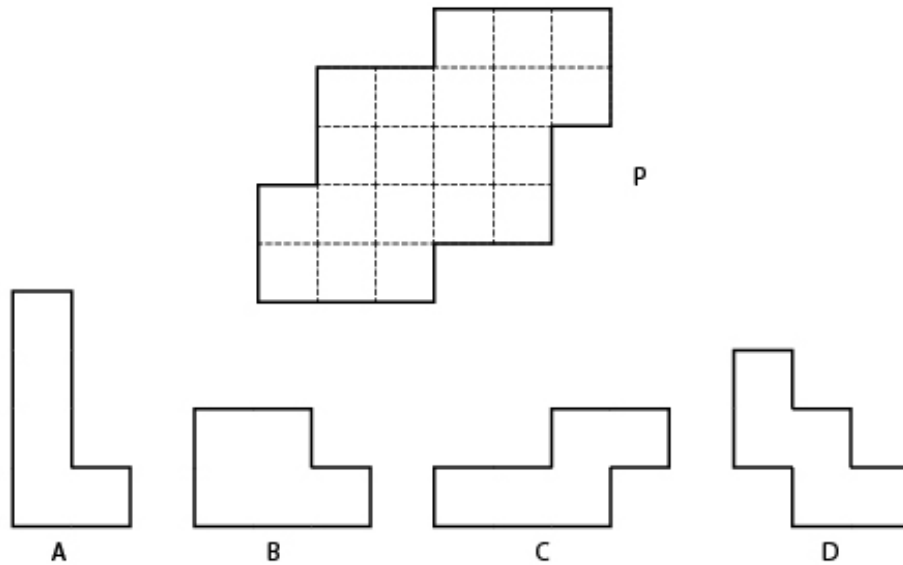

**Q.16** An animation of shapes morphing from one to another is shown in the GIF below. Which of the shapes shown in the options can be found in this animation sequence in its exact orientation and size?

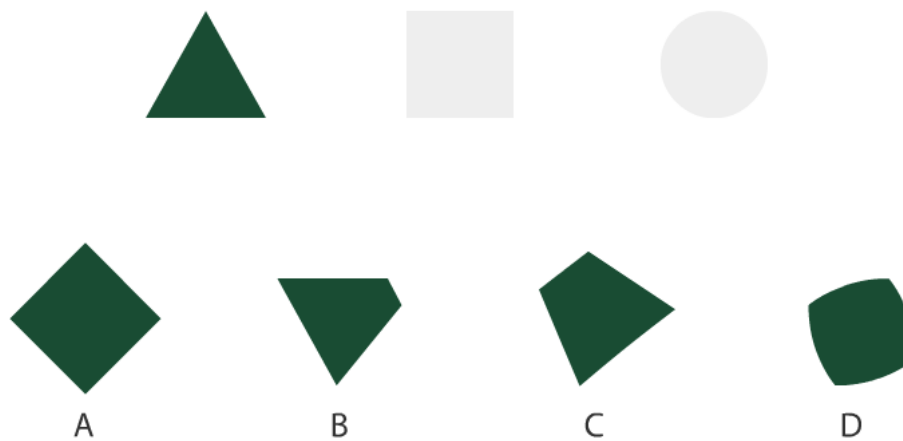

**Q.17** Tile X was used to create a pattern which is seamless (without gaps) when arranged as shown in Y. Which tile(s) from the options will create a seamless pattern?

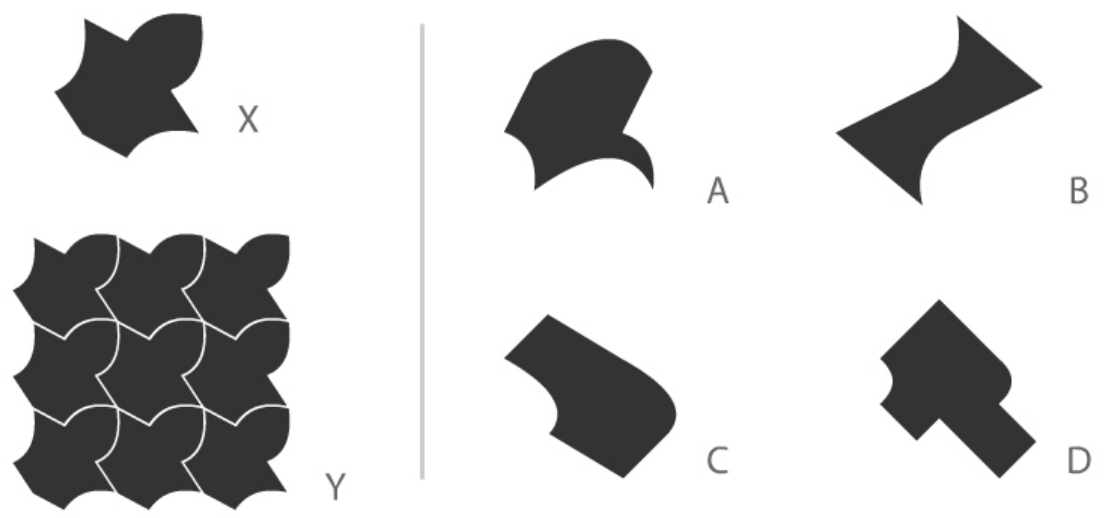

**Q.18** Some configurations for the pair of scissors are shown below. If concentric circles represent hinges, which of the options will work?

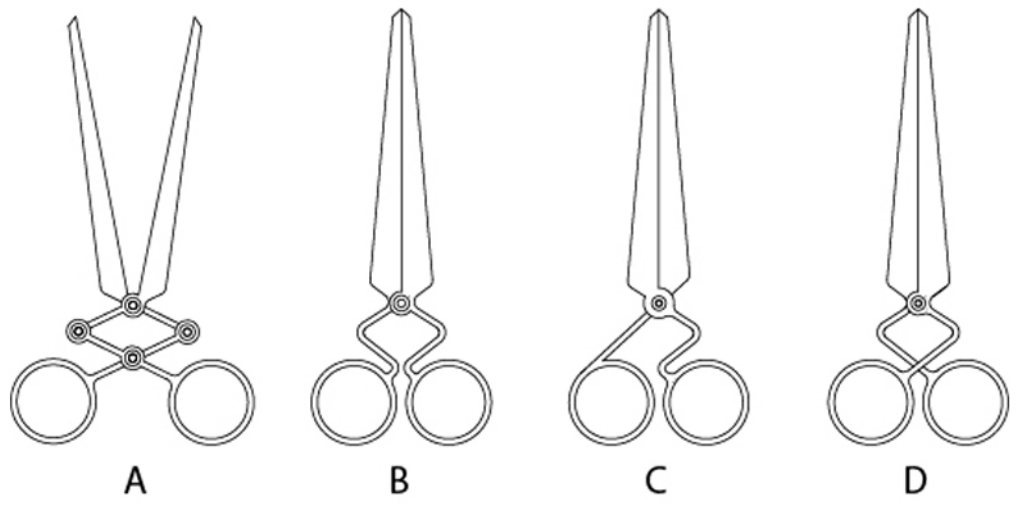

## Part A – Section III: Multiple Choice Questions

**Q.19** Shown in the box are the orthographic views of a 3D object. Which option represents that object?

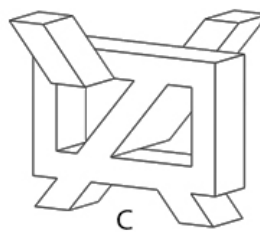
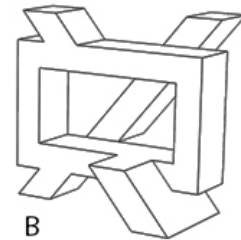
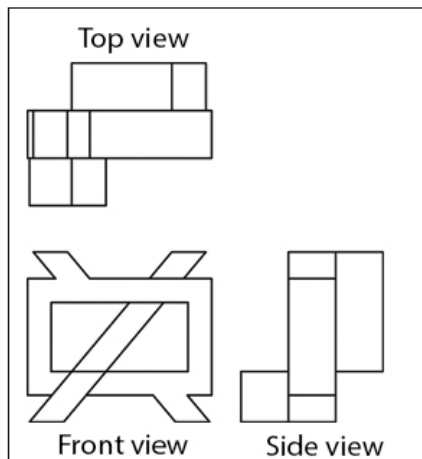

**Q.20** A washbasin is to be installed in a college canteen in India. Which of the options can help derive the appropriate height of the washbasin from the floor?

- A. Average height of the adult Indian male and female population
- B. Average height of the tallest 50% adult Indian female population
- C. Average height of the shortest 5% adult Indian female population
- D. Average height of the shortest 5% adult Indian male population

**Q.21** Image X represents the six faces of a cube. Image Y shows a composition using five such cubes. What could be the rear view of the shown composition?

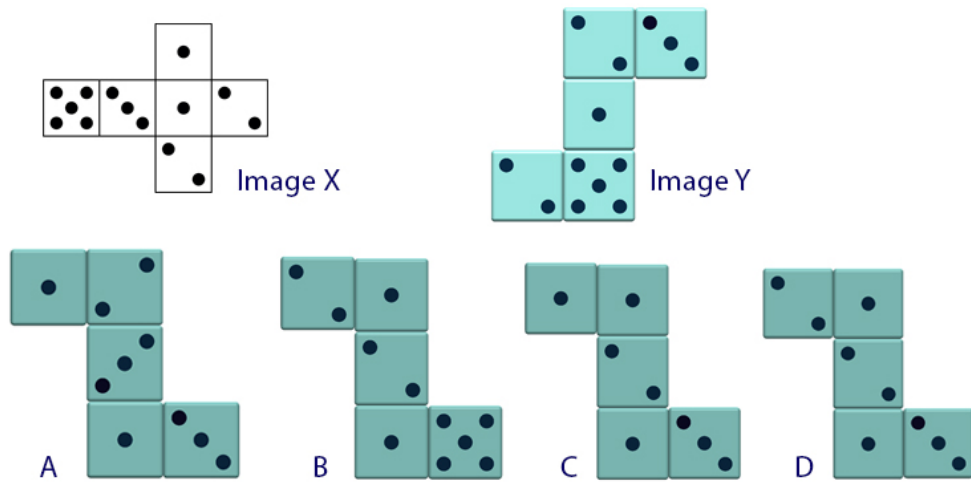

**Q 22** Shown below are two parts of a mould. Mould is closed and material is poured into the cavity. What would be the resultant moulded part?

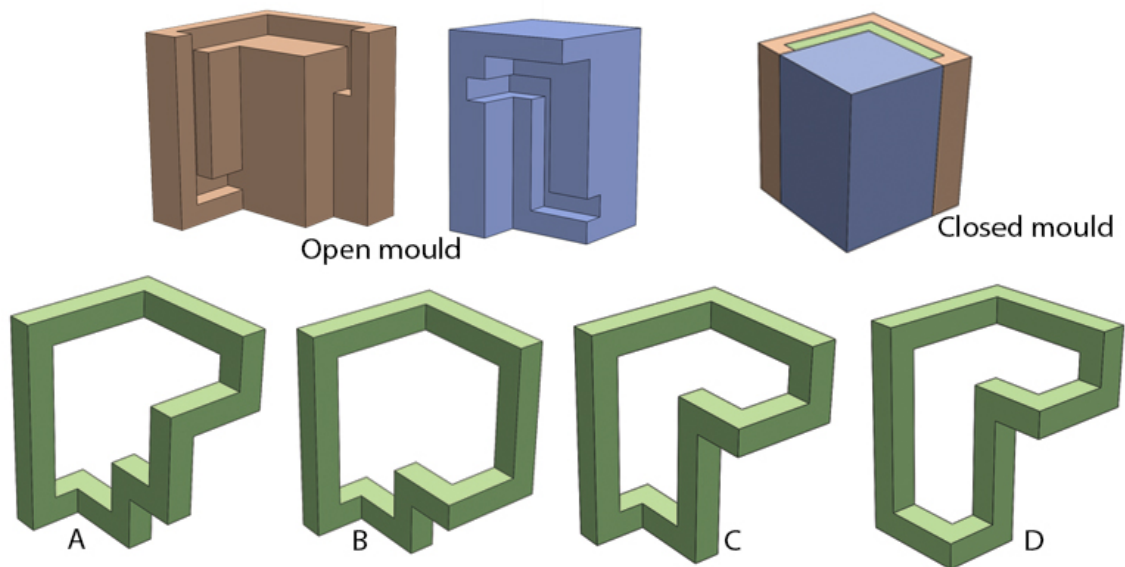

**Q.23** Three leaves are falling from a tree. Figure 1 shows the way a leaf falls. Figure 2 illustrates the starting orientation of the three leaves. If the blue colour leaf is at 200 cm, the red colour leaf is at 425 cm and the yellow colour leaf is at 375 cm from the ground, then what would be the orientation of all the leaves when they reach the ground?

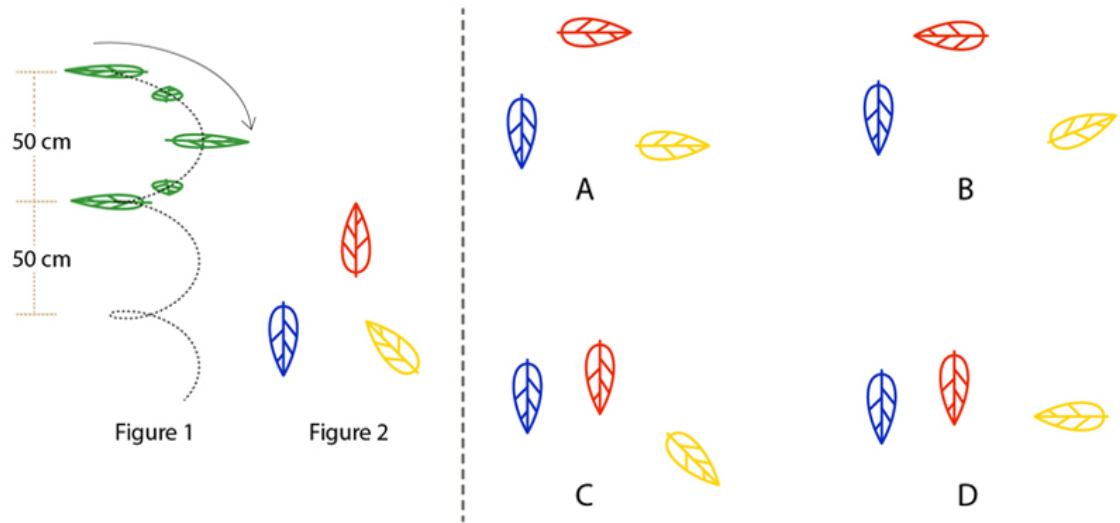

**Q.24** Which option resembles an angry person when flipped vertically?

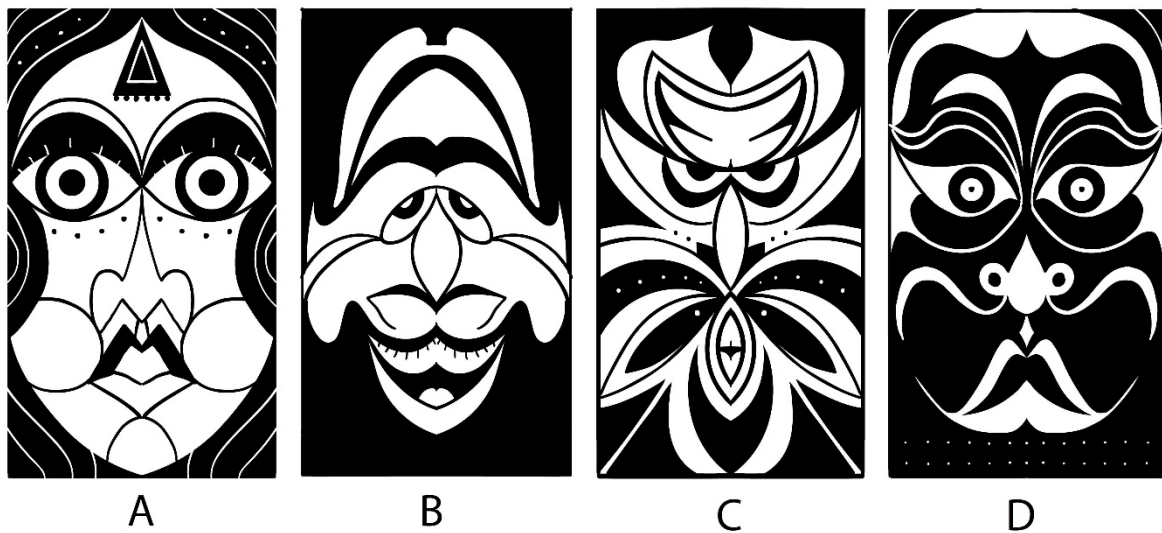

**Q.25** Eleven identical circles are linked together by line segments that connect the centres of adjoining circles as shown in the figure below. Which of the statements is **TRUE**?

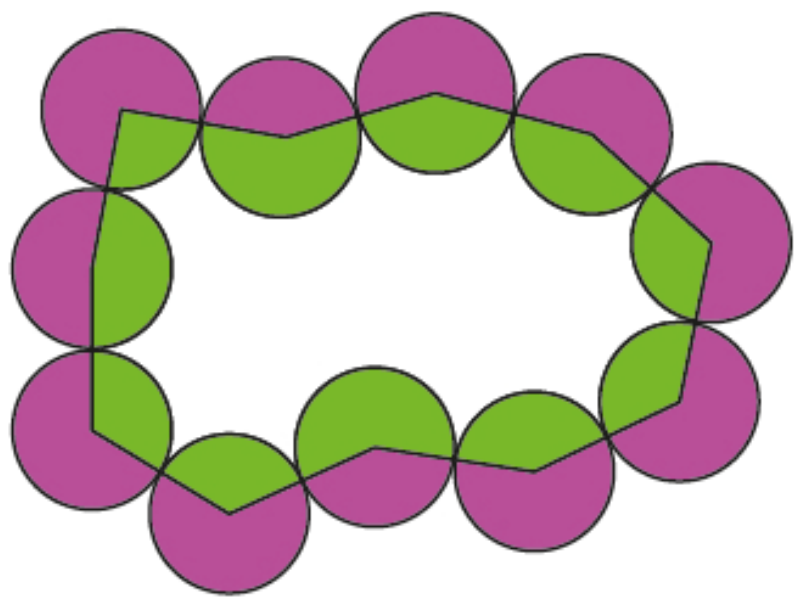

- A. Purple area is equal to the green area
- B. Purple area is greater than green area by one circle
- C. Purple area is greater than green area by two circles
- D. Purple area is greater than green area by three circles

**Q.26** Identify the odd one.



A

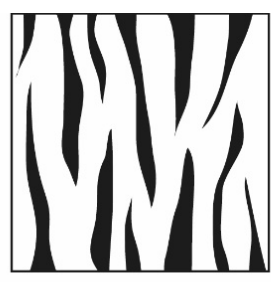

B

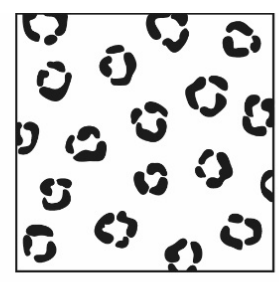

C

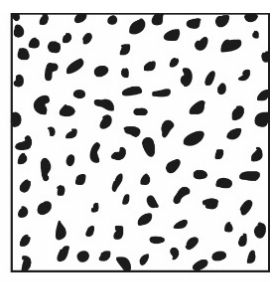

D

**Q.27** Shown on the left is a woven mat using threads of two colours. The mat is flipped at the edge Q to reveal the back side. Identify the back side of the mat from the given options.

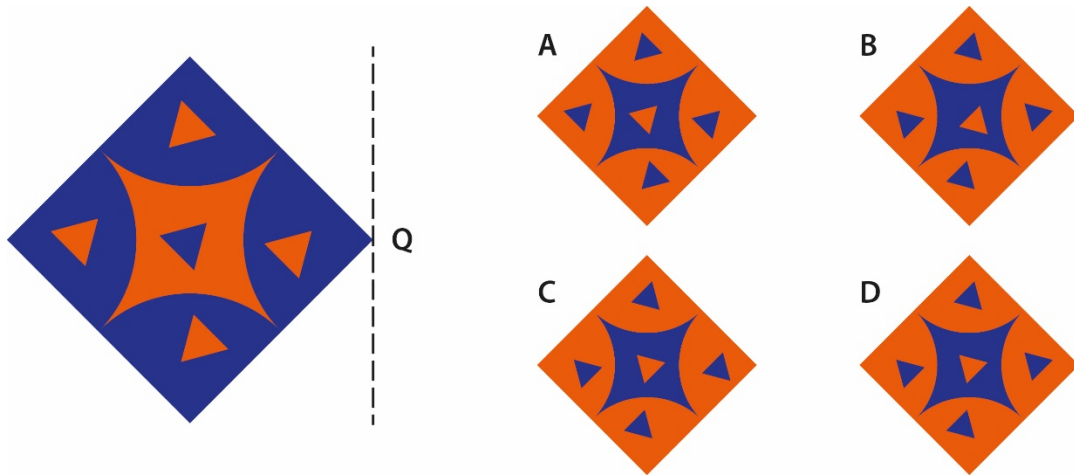

**Q.28**

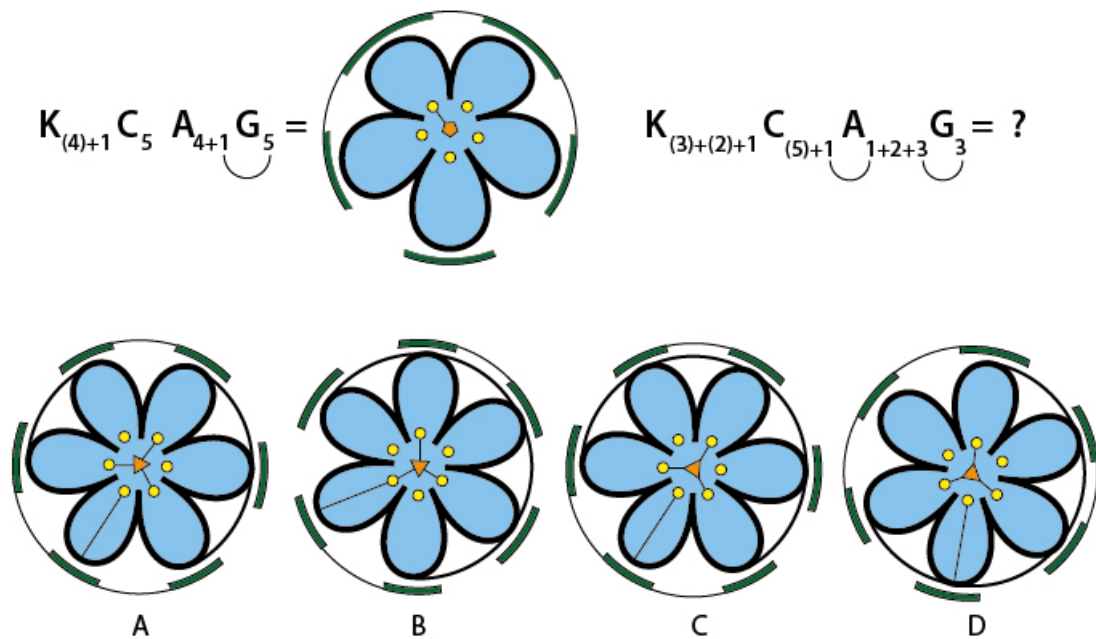

**Q.29** A folding fan shown in the image is made of bamboo and paper painted on one side. Which option is the closest representation of the same fan in the folded position? (dotted lines indicate the folds)

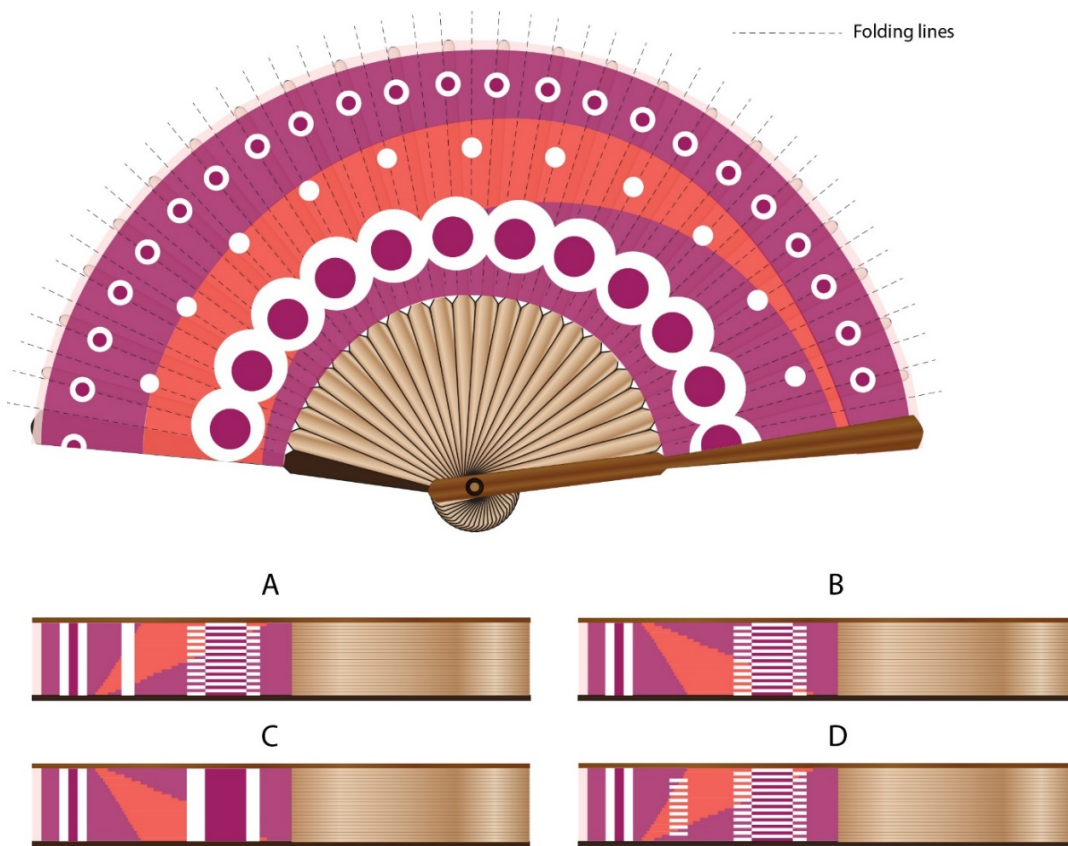

**Q.30** Roads are generally made with an angle on the curvatures to counter the centrifugal force on vehicles moving with speed. This is called 'Banking of Road'. Figure shows two one-way roads P and Q from top view. If the maximum safe speed limit is same for both the roads, which option shows the schematic cross section of P and Q at the position SS?

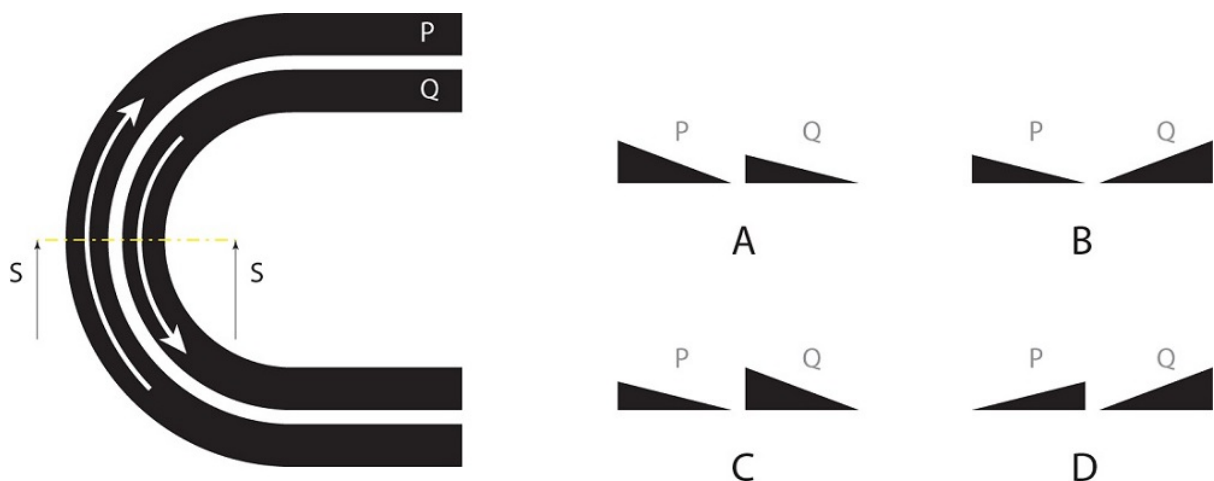



**Q.31** Which option will fold into the pack shown in the image below?

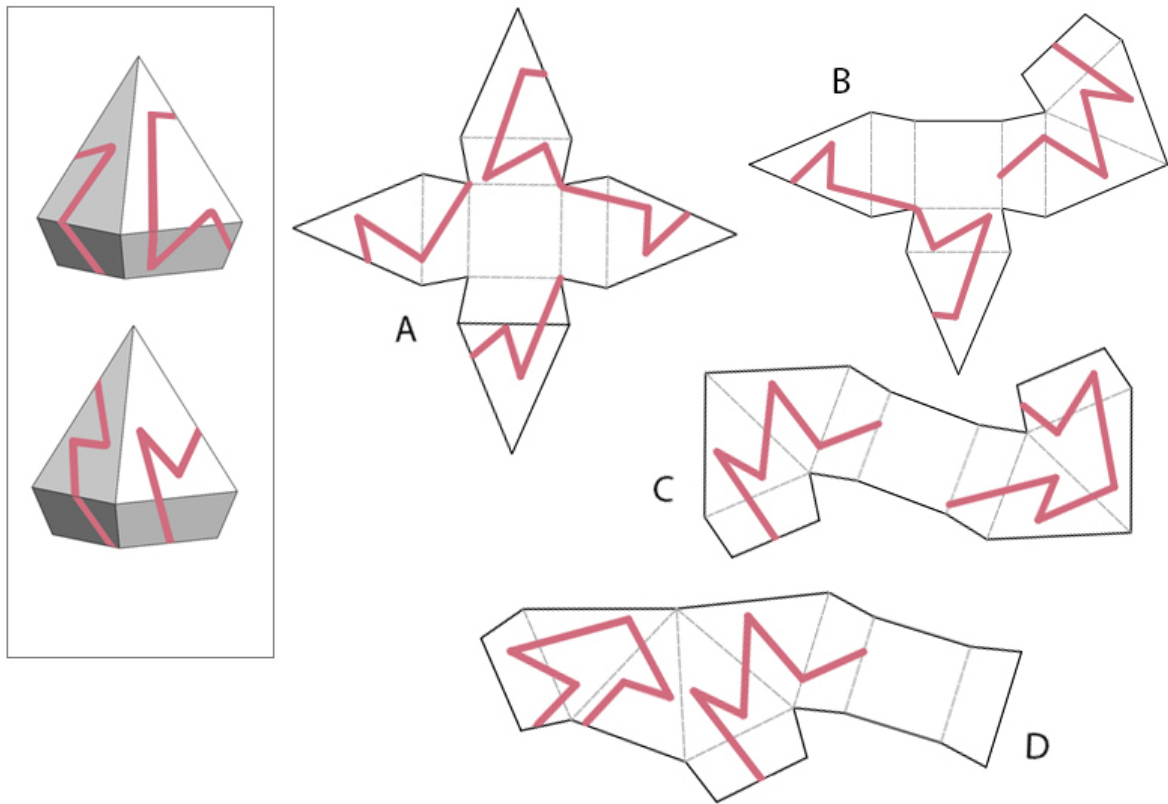

**Q.32** A closed loop is made of a metal pipe and is rolling between two fixed pulleys as shown in the image on the left. What would be the path traced by point P when the loop completes one turn?

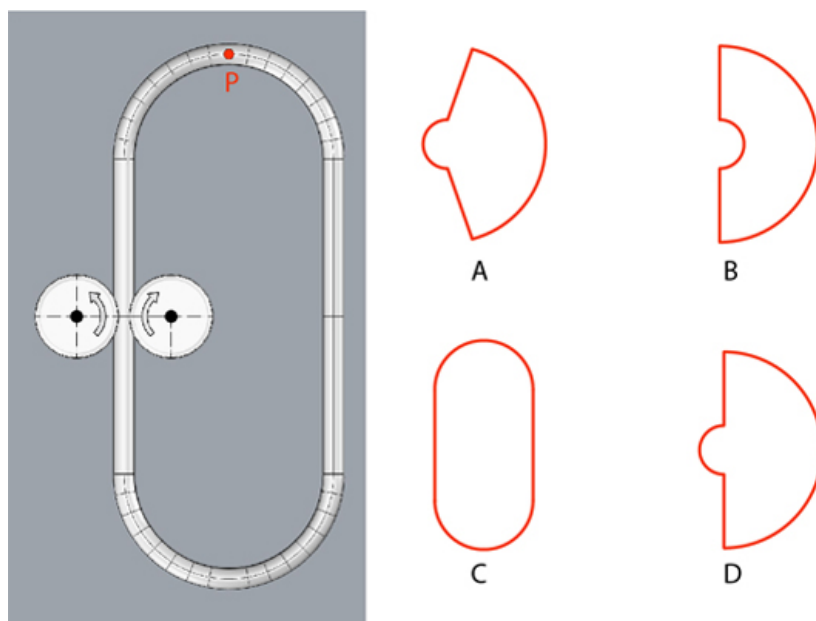

**Q.33** Biomimicry is the practice of looking to nature for inspiration to solve design problems. Shown below are plants and animals (top row) that have inspired the design of products (bottom row).

Which of the options listed below correctly identifies the plant and/or animal with the product that it inspired?



P

Q

R

S



1

2

3

4

- A. P – 3, Q – 1, R – 4, S – 2
- B. P – 4, Q – 2, R – 1, S – 3
- C. P – 3, Q – 4, R – 1, S – 2
- D. P – 1, Q – 3, R – 2, S – 4

**Q.34** Image below shows configurations of jars filled with water. Which option will work as an air filter?

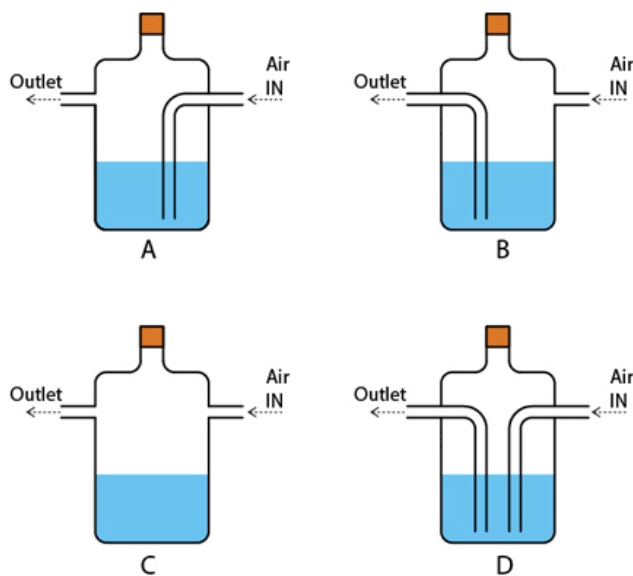

**Q.35** Which of the options, when combined with block shown on top, will result in perfect 4x4x4 cube?

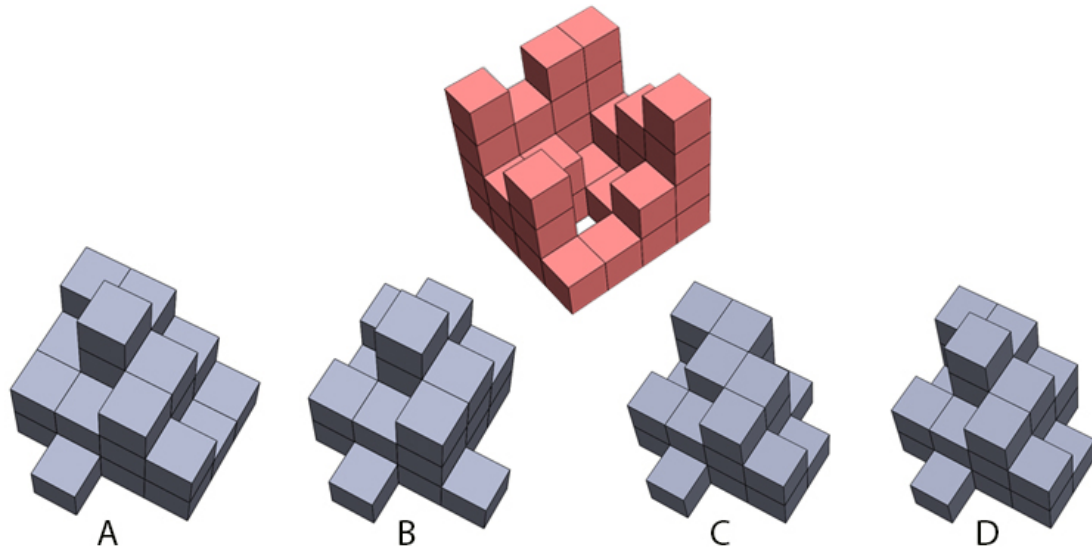

**Q.36** Which of the options will result in the form shown on the left, when revolved around  $x-x'$  axis?

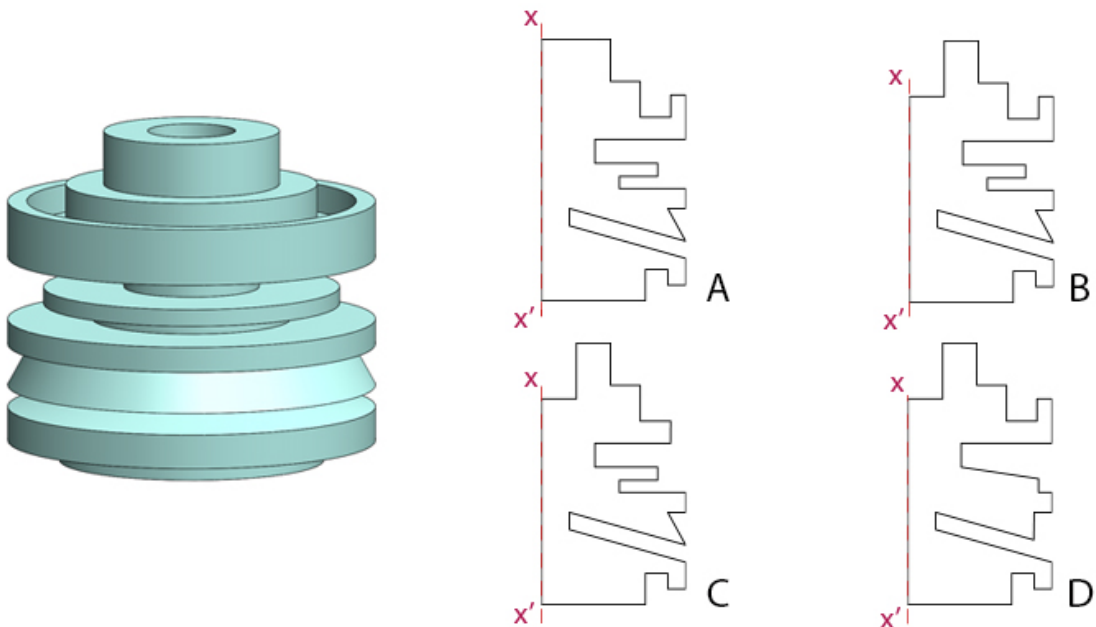

**Q.37** Figure 1 shows the skeleton of a T-rex dinosaur. Identify the correct distorted silhouette from the given options.

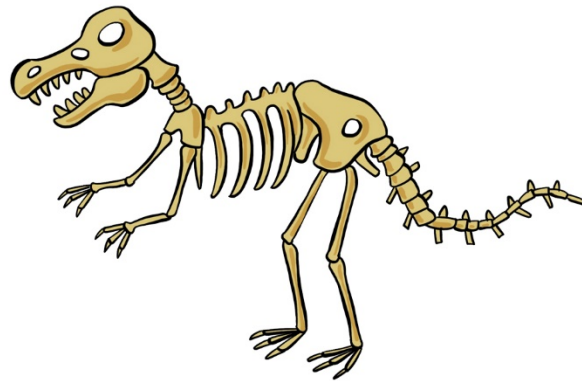
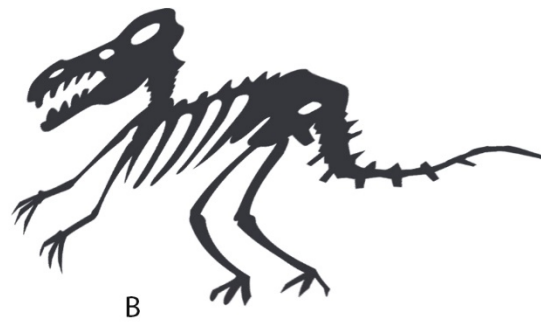
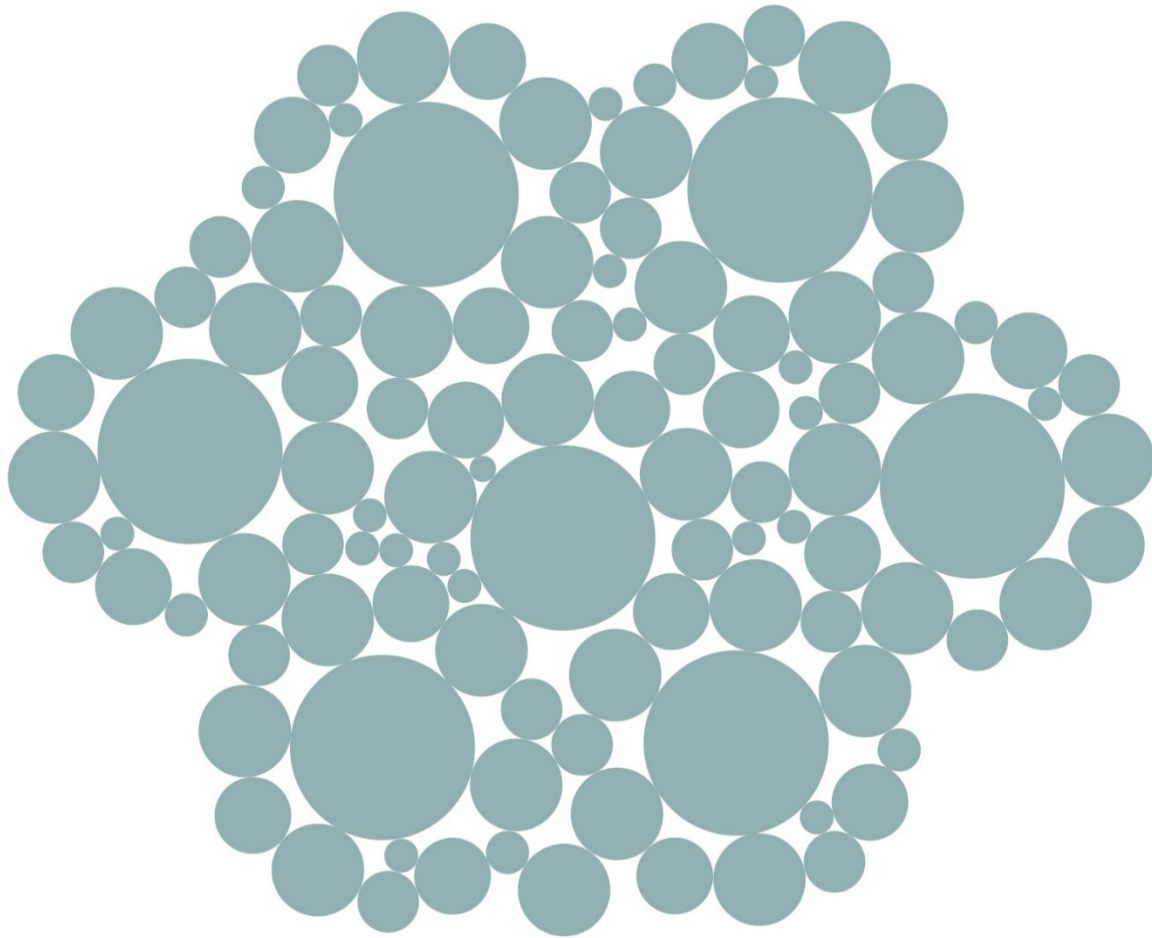

Figure.1



**Q.38** Circles of how many different radii are needed to construct the following figure?



- A. 4**
- B. 5**
- C. 6**
- D. 7**

**Q.39** A printed transparent sticker (as shown on the left) is applied onto a glass cylinder such that the vertical edges meet. Which option is the correct representation?

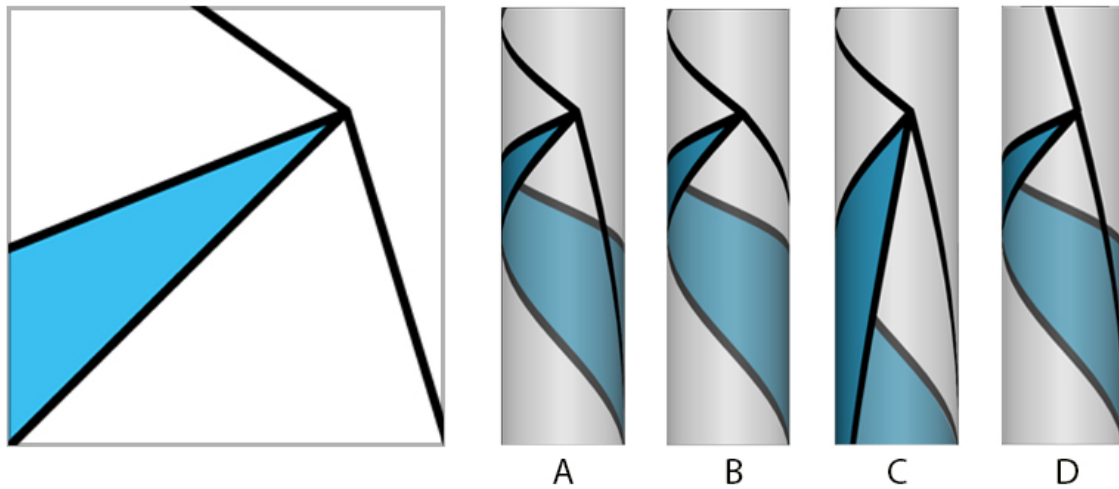

**Q.40** Image on the left shows a cylinder kept on the top of a cube. Height of the cylinder and side of the cube are equal. Parallel rays of light are falling on them at an angle of 45 degree. Which option shows the correct shadow?

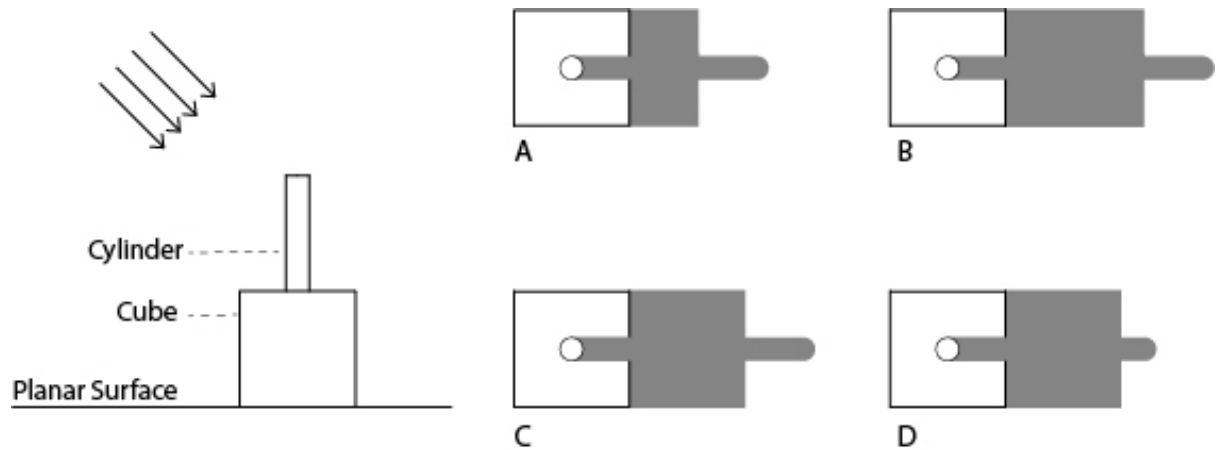

**Q.41** Shown on the left is a futon that becomes a mattress when opened and folds into a seat. Which option **CANNOT** be folded as a seat?

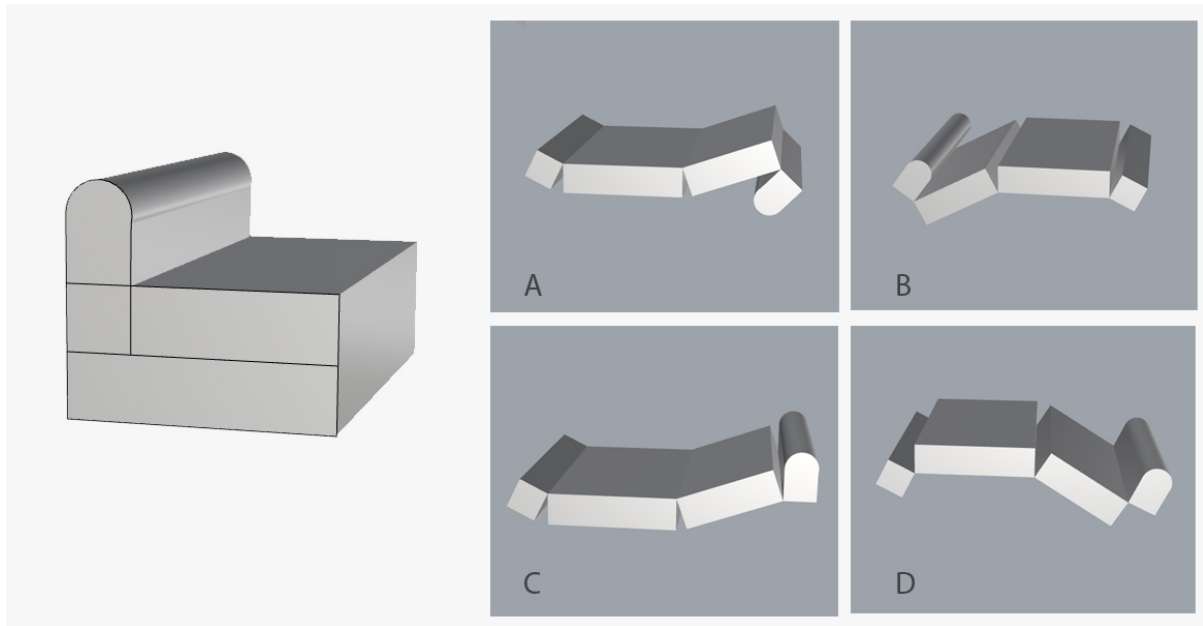

## **Part B**

**All questions are mandatory**

### **Q.1 Sketching** (20 marks)

A sample is being collected for an RT-PCR swab test for COVID-19. The man collecting the sample is standing in a PPE (protective) suit. The lady who is being tested is sitting on a chair in front of him. She shows uneasiness through her facial expression when a swab is inserted in her nose.

Draw a free-hand sketch of the moment described above. Drawing of surroundings is not necessary.

#### **Evaluation criteria:**

- Quality of composition
- Observation and drawing skills
- Expression of the person being tested
- Scale and relative proportions
- Use of light and shade



**Q.2 Creativity** (4 x 5 = 20 marks)

Building upon the visual elements given in the five boxes, create recognizable images and give a title to each one. Use only BLACK pencil/pen. Draw only within the boundaries of the boxes.

**Evaluation criteria:**

- Originality – ability to produce unusual response
- Emotional expressiveness – ability to communicate feelings and emotions non-verbally through figures
- Humour / surprise – ability to depict conceptual and perceptual absurdity and amusing combinations
- Richness – ability to create strong, sharp and distinct images

**Q.3 Visual Sensitivity** (4x5 = 20 marks)

Create visual icons in the boxes given, for the following in an Indian mela (fair/exhibition)

1. Information Desk
2. Craft zone
3. Children zone
4. Game zone

**Evaluation criteria:**

- Aesthetics of 2D form
- Effectiveness to convey meaning
- Consistency of visual language (style)
- Composition

#### Q.4 Form sensitivity (20 marks)

Three views of a building are shown below. Visualise the form of an electric iron (for ironing clothes) based on the image(s) of the given building. It should match the design language with relevant details. Sketch and render the form of the electric iron.

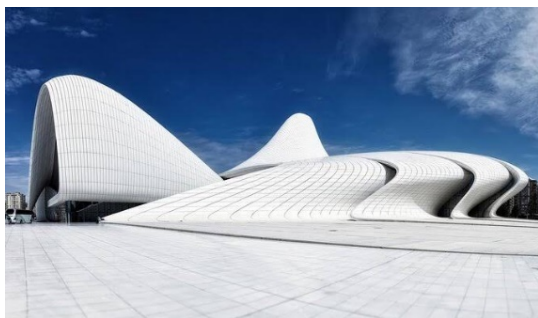

#### Evaluation Criteria:

- Sensitivity towards form
- Consistency with the visual language of the form
- Relevant details of the iron
- Surface shading
- Quality of lines/strokes

**Q.5 Problem identification** (10 + 2x5 = 20 marks)



*Image source: thehindu.com*

Getting into the general compartment of a long-distance train is not a pleasant experience, especially for women, children, elderly and the disabled. The photo depicts one such scene.

In the space provided in the answer booklet, list TEN unique design problems or opportunities in this situation. Each problem or opportunity could be based on either what you can observe in the photo or your experiences as a passenger. Each problem or opportunity should have potential for a design solution. For example, large crowds or less availability of seats are not design problems. (10 marks)

Within the space provided clearly illustrate TWO design problems or opportunities that you consider to be the most important. (2x5 marks)

Focus on depicting problems and opportunities. DO NOT provide solutions.

**Evaluation criteria:**

1. Severity of the identified problems
2. Diversity of observations
3. Analytical skills
4. Communication

## CEED 2022 ANSWER KEY

### SECTION – I (NAT)

Q. No.	KEY RANGE	Q. No.	KEY RANGE	Q. No.	KEY RANGE	Q. No.	KEY RANGE	Q. No.	KEY RANGE
01	27	02	3214765	03	5	04	0.5	05	112
06	7.2	07	420	08	14				

### SECTION – II (MSQ)

Q.No.	KEYS	Q.No.	KEYS	Q.No.	KEYS	Q.No.	KEYS	Q.No.	KEYS
09	B, D	10	D	11	B, D	12	A, C, D	13	B, C
14	A, B	15	B, C	16	C, D	17	A, C, D	18	A, C, D

### SECTION – III (MCQ)

Q.No.	KEY	Q.No.	KEY	Q.No.	KEY	Q.No.	KEY	Q.No.	KEY
19	D	20	C	21	D	22	C	23	C
24	C	25	C	26	A	27	D	28	C
29	B	30	C	31	C	32	D	33	C
34	A	35	D	36	B	37	C	38	D
39	A	40	C	41	C				