

GIC Assistant Manager

**Previous Year Paper
2021**

Direction: Read the given passage carefully and answer the questions that follow.

The It Act 2000 attempts to change outdated laws and provides ways to deal with cyber crimes. We need such laws so that people can perform purchase transactions over the Net through the cards without any fear of misuse. The Act offers the much needed legal framework so that information is not denied legal effect, validity or enforceability, solely on the ground that it is in the form of electronic records.

In view of the growth in transactions and communications carried out through electronic records, the Act seeks to empower government departments to accept filling, creating and retention of official documents in the digital format. The Act has also proposed a legal framework for the authentication and origin of electronic records/communications through digital signature.

From the perspective of e-commerce in India, the IT Act 2000 and its provisions contain many positive aspects. Firstly, the implications of these provisions for the e-businesses would be that email would now be a valid and legal form of communication in our country that can be duly produced and approved in a court law. Companies shall now be able to carry out electronic commerce using legal infrastructure provided by the Act. Digital signatures have been given legal validity and sanction in the Act. The Act throws open the doors for the entry of corporate companies in the business of being Certifying Authorities for issuing Digital Signatures Certificates. The Act allows

Government to issue notification on the web thus heralding e-governance.

The Act enables the companies to file any form, application or any other document with any office, authority, body or agency owned or controlled by the appropriate Government in electronic form by means of such electronic form as may be prescribed by the appropriate Government. The IT Act also addresses the important issues of security, which are critical to the success of electronic transactions. The Act has given a legal definition to the concept of secure digital signatures that would be required to have been passed through a system of security procedure, as stipulated by the Government at a later date. Under the IT Act 2000, it shall now be possible for the corporates to have a statutory remedy in case if anyone breaks into their computer systems or network and causes damages or copies data. The remedy provided by the Act is in the form of monetary damages not exceeding 1 crore.

Source: Wikipedia

1. What was the main purpose behind the IT Act 2000?

- A. To provide legal recognition to transactions.
- B. To enforce digital payments and make it more common among people
- C. To consider electronic records legal and suppress cyber crime to a great extent.
- D. To proclaim the introduction of Digital Signatures.
- E. To give e-commerce and e-business a boost in the economy.

2. How was this Act beneficial for IT business hubs?

- A. It opened the door for the IT officials to recognize themselves more in terms of digital signatures.
- B. It proved the efficacy of the individuals in the corporate world.
- C. It widened Indian outsourcing by providing security benefits.
- D. Digital activities were given more importance and validation, which made things easier for the companies.
- E. It reduced restrictions and limitations of companies to expand and they could enhance their terms with any company easily.

3. In which sphere is the positive aspect of IT Act most dominant?

- A. Offline business
- B. E-commerce
- C. Secure Electronic Transactions
- D. Digital Signatures
- E. Bank transactions

4. What is the main reason that it was considered important to pass this Act?

- A. The growth of so many small companies in cities made it compulsory that digital transactions be given a new place in business.
- B. The growth of technology in every sphere of life.
- C. The increase in cyber crimes in every sphere of life.
- D. Importance of issuing notices by the government on the Internet.
- E. To popularize e-commerce was important in India from the point of economy.

5. Which of the following is ensured through this Act?

- A. Security
- B. Business opportunities
- C. More facilities on electronic media
- D. Reduction of taxes
- E. Consideration of technological damages

Directions: Read the sentence to find out whether there is any error in it. The error, if any, will be in one part of the sentence. The number of that part is the answer. If the given sentence is correct as it is, the answer is (5) i.e. No error. Ignore errors of punctuation if any.

6. The bank will decide (1)/ unless Ashok is (2)/ eligible for a loan (3)/ based on his monthly salary. (4)

- A. 1
- B. 2
- C. 3
- D. 4
- E. No error

Directions: Read the sentence to find out whether there is any error in it. The error, if any, will be in one part of the sentence. The number of that part is the answer. If the given sentence is correct as it is, the answer is (5) i.e. No error. Ignore errors of punctuation if any.

7. The rate of interest (1)/ offered by banks to (2)/ customers who had savings bank Account (3)/ was decided by RBI early. (4).

- A. 1
- B. 2
- C. 3
- D. 4
- E. No error

Direction: Read the sentence to find out whether there is an error in it. The error, if any, will be in one part of the sentence. The number corresponding to that part will be your answer. If the given sentence is correct as it is, mark the answer as 'No error'. Ignore the errors of punctuation, if any.

8. The social media channel (1)/ has been considering to remove (2)/ the number of 'likes' on posts (3)/ for quite some time now. (4)

- A. 1

- B. 2
- C. 3
- D. 4
- E. No Error

Direction: Read the sentence to find out whether there is an error in it. The error, if any, will be in one part of the sentence. The number corresponding to that part will be your answer. If the given sentence is correct as it is, mark the answer as 'No error'. Ignore the errors of punctuation, if any.

9. The only national-security question that has (1)/ caught fire is the government's refusal to (2)/ publishing a parliamentary report on alleged (3)/ Russian meddling in British politics. (4)

- A. 1
- B. 2
- C. 3
- D. 4
- E. No Error

Direction: In the following question, two **columns I and II**, each containing three sentences are given. **Column I** consists of the first part of three sentences and **Column II** consists of the remaining part of those three sentences. Match **column I** with **column II**, so that the sentences formed are meaningful and grammatically correct.

10. I.

- A) She go crazy like a kid
 - B) With awe and wonder, we looked
 - C) We live a life that has little place
- II.
- D) At the small creatures that looked like tiny lanterns.
 - E) For nights steeped in darkness.
 - F) When food is ordered through mobile applications.
- A. B-D and C-E
 - B. A-E, B-F and C-D

- C. A-F and C-D
- D. B-F
- E. A-E and C-F

Direction: In the following question, two **columns I and II**, each containing three sentences are given. **Column I** consists of the first part of three sentences and **Column II** consists of the remaining part of those three sentences. Match **column I** with **column II**, so that the sentences formed are meaningful and grammatically correct.

11.

I.

- A. In a setback to the Gujarat Congress,
- B. Every five minutes, he calls out asking for this and that,
- C. The development of laser science made possible

II.

- D. and by the time he leaves I am a hour behind schedule.
 - E. the study of light as governed by quantum theory.
 - F. its veteran leader Kunvarji Bavalia resigned as legislator.
- A. B-E and C-F
 - B. A-E, B-F and C-D
 - C. A-F and C-D
 - D. A-F and C-E
 - E. B-D and C-F

Direction: In this question, two **columns I and II** and three sentences are given, which are divided into two parts. **Column I (A, B and C)** consists of first half of each sentence and **Column II (D, E and F)** consists of second half of each sentence. Match column I with column II, so that the sentences formed are both meaningful and

grammatically correct. Choose the option as your answer.

12.

I.

A) The Prime Minister inaugurated the India-Bangladesh Friendship Bridge (Maitri Setu)

B) Identification of an area as forest area is solely based on the declaration

C) She opined that political boundaries should not become

II.

D) barriers to trade and economic relations.

E) to be filed by the user agency.

F) at the Feni river at Sabroom in south Tripura.

A. B-E and C-D

B. A-E, B-D and C-F

C. A-F and B-D

D. B-F

E. A-E and C-F

Direction: In the given question, a part of the sentence is printed in bold. Below the sentence alternatives to the bold part are given at (A), (B), (C) and (D) which may help improve the sentence. Choose the correct alternative. In case the given sentence is correct, your answer is (E), i.e., 'No correction required'.

13. A group of students was roaming hither and thither **in the streets**.

A. On the streets

B. Upon the streets

C. Over the street

D. Into the streets

E. No change required

Direction: In the given question, a part of the sentence is printed in bold. Below the sentence, alternatives to the bold part are given at (A), (B), (C) and (D) which may help improve the sentence. Choose the correct alternative. In case the given sentence is correct and needs no

improvement, your answer is (E), i.e., 'No correction required'.

14. The quality of performance and other **factors are** more important than mere higher qualification in case of internal promotion.

A. Factors on

B. Factor was

C. Factors were

D. Factors will

E. No correction required

Direction: In the given question, a part of the sentence is printed in bold. Below the sentence, alternatives to the emboldened part are given as (A), (B), (C) and (D), which may help improve the sentence. Choose the correct alternative out of the given five options. In case the given sentence is correct, your answer will be option (E), i.e., "No correction required".

15. **Unless you do not try to** do something beyond what you have already mastered, you will never grow.

A. Unless you try to

B. Until you do not try to

C. Had you tried to

D. If there had been a possibility to

E. No correction required

Direction: Read the passage carefully and answer the questions that follow.

I decided I was a feminist and this seemed uncomplicated to me. But my recent research has shown me that feminism has become an unpopular word. Apparently, I am among the ranks of women whose expressions are seen as too strong, too aggressive, isolating, anti-men and, unattractive. Why is the word such an uncomfortable one?

I am from Britain and think it is right that as a woman I am paid the same as my male counterparts. I think it is right that I should be able to make decisions about my own body. I think it is right that women be involved on my behalf in the policies and decision-making of my country. I think it is right that socially I am afforded the same respect as men. But sadly, I can say that there is no one country in the world where all women can expect to receive these rights.

No country in the world can yet say they have achieved gender equality.

These rights I consider to be human rights but I am one of the lucky ones. My life is a sheer privilege because my parents didn't love me less because I was born a daughter. My school did not limit me because I was a girl. My mentors didn't assume I would go less far because I might give birth to a child one day. These influencers were the gender equality ambassadors that made me who I am today. They may not know it, but they are the inadvertent feminists who are changing the world today. And we need more of those.

And if you still hate the word—it is not the word that is important but the idea and the ambition behind it. Because not all women have been afforded the same rights that I have. In fact, statistically, very few have been.

In 1995, Hilary Clinton made a famous speech in Beijing about women's rights. Sadly, many of the things she wanted to change are still a reality today.

But what stood out for me the most was that only 30 per cent of her audience were male. How can we

affect change in the world when only half of it is invited or feel welcome to participate in the conversation?

Men—I would like to take this opportunity to extend your formal invitation. Gender equality is your issue too.

- See more at:
<https://www.unwomen.org/en/news/stories/2014/9/emma-watson-gender-equality-is-your-issue-too#sthash.sUcJYxPg.dpuf>

16. Why can't all women afford the same rights of feminism today?

- A. Because of the patriarchal society
- B. Because feminism is involved with anti-men notion
- C. Because not everyone advocates for women's rights
- D. Because feminism is complicated
- E. Because feminism is an overrated topic

17. What is the difference between Gender Equality and Feminism?

- A. Feminism puts women at the top of the hierarchy since they give birth to the next generation.
- B. Feminism and Gender Equality are inter-related
- C. Feminism is an anti-men movement
- D. Both B and C
- E. None of the above

18. Why is Feminism an issue for men too?

- A. Because men think they are incapable of leading the world
- B. Because men think women are more capable of leading the world
- C. Because every individual should have equal rights
- D. Because feminism directly involves men
- E. None of the above

19. Why can't any country in the world yet say they have achieved gender equality?

- A. Because women are still restricted
- B. Because women are better in household works
- C. Because world leaders are misogynist
- D. Because the reports show it clearly
- E. All of the mentioned

20. "Only 30 per cent of her audience were male". Why?

- A. Feminism is an anti-men movement
- B. Feminism is preached wrong
- C. Most men are misogynist
- D. Most men see through the problem
- E. All of the above

Direction: What should come in place of the question mark '?' in the following number series?

21. 4, 27, 160, 797, 3184, ?

- A. 7125
- B. 7568
- C. 9065
- D. 9547
- E. 9825

Direction: What should come in place of question mark (?) in the following number series?

22. 125, 137, 131, 155, 149, ?, 179, 227

- A. 197
- B. 185
- C. 165
- D. 150
- E. None of these

23. 600, 300, 450, 1125, ?

- A. 2250
- B. 2425.75
- C. 3237.5
- D. 3937.5
- E. None of these

24. 5, 11, 46, 279, ?

- A. 2220
- B. 2252
- C. 3324
- D. 3400
- E. None of these

Directions: The question consists of three statements numbered "I, II and III" given below it. You have to decide whether the data provided in the statements are sufficient to answer the question.

25.

What is the present age of Shabana?

Statement I: At the time of marriage, the total age of Shabana and her husband was 50 years.

Statement II: The difference between the present age of Shabana and her daughter is 25 years.

Statement III: At the time of the marriage, the age of Shabana was 26 years.

A. The data in statements I and II together are necessary to answer the question while the data in statement III alone is not sufficient to answer the question.

B. The data in statements II and III together are necessary to answer the question while the data in statement I alone is not sufficient to answer the question.

C. The data in statements I and III together are necessary to answer the question while the data in statement II alone is not sufficient to answer the question.

D. The data in all the statements I, II and III together is not sufficient to answer the question.

E. The data in any two statements together are necessary to answer the question.

Directions: The question consists of three statements numbered "I, II and

III" given below it. You have to decide whether the data provided in the statements are sufficient to answer the question.

26.

Find the time taken by pipe Z alone to empty the full tank, if three pipes X, Y and Z are connected to a tank.

Statement I: Pipe X and Y together can fill the tank in 1 hour.

Statement II: Pipe X and Z together can fill the tank in 3 hour 30 minutes.

Statement III: Pipe X, Y and Z together can fill the tank in 1 hour 24 minutes.

A. The data in statements I and II together are sufficient to answer the question, while the data in statement III alone are not sufficient to answer the question.

B. The data in statements I and III together are sufficient to answer the question, while the data in statement II alone are not sufficient to answer the question.

C. The data in statements II and III together are sufficient to answer the question, while the data in statement I alone are not sufficient to answer the question.

D. The data either in statements I and II together or in statements II and III together are sufficient to answer the question.

E. The data in all three statements I, II and III together are necessary to answer the question.

27. A person marked the price of his products 60% above their cost price. He sold 40% of the products at 20% profit and 25% of the remaining products at marked price and remaining products at 25% discount. Find his overall profit percentage.

A. 26%

B. 24%

C. 28%

D. 32%

E. None of these

28. A man can row with the speed of 33 km/hr in still water and the speed of current is given as 7 km/hr. He rows to a certain distance upstream and comes back to the starting point in total of 16.5 hrs. Find the new speed of the man in still water if he rows upstream and come back the same distance in 31 hr. 40 min.

A. 15 km/h

B. 19 km/h

C. 23 km/h

D. 25 km/h

E. 27 km/h

29. Vansh drives a car 20% faster than that of Yash. Both started at the same time from Muzaffarnagar but unfortunately Vansh's car broke down on the way due to this he wasted 2 hour. Find the speed of the Vansh if both of them reached Delhi at the same time and the distance between Muzaffarnagar and Delhi is 150 km.

A. 24 km/h

B. 18 km/h

C. 20 km/h

D. 15 km/h

E. None of these

30. P and Q started a business together in a partnership. Q left the business after 8 months and at the same time P doubles his investment. Profit at the end of year is Rs. 4680, out of which profit of Q is Rs. 3510, find the investment of Q is how much percentage more than the investment of P initially?

A. 350%

B. 300%

C. 450%

D. 500%

E. 400%

31.The computer's processor consists of which of the following parts?

- A. CPU and Main Memory
- B. Hard Disk and Floppy Drive
- C. Main Memory and Storage
- D. Operating system and Applications
- E. Control Unit and ALU

32.Which one of the following is a key function of a firewall?

- A. Monitoring
- B. Deleting
- C. Copying
- D. Moving
- E. None of these

33.In most WANs, the network contains numerous cables of telephone lines, each one connecting a pair of _____.

- A. Packet
- B. Star topology
- C. Router
- D. Antennas
- E. None of these

34.The Fifth generation computing devices, based on _____.

- A. artificial intelligence
- B. Very large scale integration (VLSI)
- C. Both of above
- D. SQL
- E. None of these

35.How many margins are there on a page?

- A. Two (header and footer)
- B. Four (top, bottom, right, left)
- C. Two landscape and portrait
- D. Two (top and bottom)
- E. None of these

36.

The purpose of the primary key in a database is to_____.

- A. unlock the database
- B. a relationship between two tables
- C. uniquely identify a record

D. establish constraints on database operations.

E. None of these

37.Which protocol provides e-mail facility among different hosts?

- A. FTP
- B. SMTP
- C. TELNET
- D. SNMP
- E. None of these

38.Which is the following shortcut key is used to checking spelling?

- A. F1
- B. F2
- C. F7
- D. F9
- E. None of these

39.When the computer is switched on, the booting process performs the_____.

- A. Integrity Test
- B. Power On Self Test
- C. Correct Functioning Test
- D. Reliability Test
- E. Shut-down

40._____are symbols used to replace or represent one or more characters.

- A. Playing cards
- B. Wildcard
- C. Private keys
- D. Public keys
- E. None of these

Direction: Study the following information carefully and answer the given questions.

Eight people i.e. A, B, C, D, E, F, G and H were born on eight different months i.e. January, February, March, July, August, September, October and December of the same year but not necessarily in the same

order. A does not born in a month having 31 days. Two people were born between A and H. B was born in a month having less than 31 days. Number of people were born before B is same as number of people were born after G. Only one person was born between G and C . Two people were born between C and D . E was born before F but not on October.

41.

How many people were born after D?

- A. Three
- B. One
- C. Two
- D. None
- E. More than three

42. Who amongst the following was born in January?

- A. B
- B. E
- C. H
- D. F
- E. None of these

43. How many people were born between H and C?

- A. Three
- B. One
- C. None
- D. More than three
- E. Two

44. G was born in which of the following months?

- A. February
- B. September
- C. October
- D. July
- E. None of these

45. How many people were born before F?

- A. Two
- B. One
- C. Three
- D. Four

E. None of these

Direction: Study the following information carefully and answer the given questions.

Nine people A, B, C, D, E, F, G, H and I are sitting in a row and all are facing north. No one sits to the right of I. C sits exactly in the middle of the row. D does not sit adjacent to neither C nor I. D is fourth to the right of F. G and H are sitting next to each other. H does not sit at any extreme end. A is second to the right of H. E is the neighbor of D but not of C .

46.

Who amongst the following sits third to the right of F?

- A. B
- B. G
- C. I
- D. E
- E. None of these

47. How many people sit between B and I?

- A. Three
- B. One
- C. Two
- D. None
- E. Four

48. How many people sit to the left of C?

- A. Four
- B. One
- C. Three
- D. Two
- E. None

49. Who sits exactly between H and B?

- A. F
- B. A
- C. D
- D. C
- E. None of these

50. How many people sit between E and F?

- A. Two
- B. One
- C. Five
- D. Three
- E. None of these

Direction: In the question below are given three statements followed by the conclusions. You have to take the given statements to be true even if they seem to be at variance with commonly known facts. Read all the conclusions and then decide which of the given conclusions logically follows from the given statements disregarding commonly known facts.

51. **Statements:**

Some Food is Plate
All Plate is Dish
Only a few Dish is Order

Conclusions:

- I. Some Plate are not Order
- II. Some Order being Food is a possibility
- A. Only I follows
- B. Only II follows
- C. Either I or II follows
- D. Neither I nor II follows
- E. Both I and II follow

52. **Statements:**

All Key is Number
Some Key are Letter
Only a few Number is Letter
No letter is Word

Conclusions:

- I. All Letter can be Key
- II. Some Number are not Word
- A. Only I follows
- B. Only II follows
- C. Either I or II follows
- D. Neither I nor II follows
- E. Both I and II follow

53. **Statements:**

Some Car is Bike

All Bike is Bus

Some Bus is Road

Conclusions:

- I. Some Road being Bike is a possibility
- II. All Car can never be Bus
- A. Only I follows
- B. Only II follows
- C. Either I or II follows
- D. Neither I nor II follows
- E. Both I and II follow

54. **Statements:**

Some Pin is Mug

Some Mug is Tin

All Tin is Bin

Conclusions:

- I. Some Pin is Tin
- II. All Mug is Bin.
- A. Only I follows
- B. Only II follows
- C. Either I or II follows
- D. Neither I nor II follows
- E. Both I and II follow

Direction: A statement is given followed by three inferences numbered I, II, and III. Consider the statement to be true even if it is at variance with commonly known facts. You have to decide which of the inferences, if any, follow from the given statement.

55. **Statement:** Maruti Suzuki's premium hatchback Swift is close to earning the tag of the Indian car that logged 100,000 bookings in the shortest time — just a little over two months — trouncing compact sedan stablemate 'Dzire', which had touched the milestone in 12-14 weeks.

Inferences:

- I. Swift is the most popular car in its segment right now.
- II. Previously, it was the Dzire which was the Indian car of the year.

III. Maruti Suzuki's cars are popular with the common people because of their reliability and efficiency.

- A. Only I follows
- B. Only II follows
- C. Only III follows
- D. Both I and II follow
- E. Both II and III follow

Direction: A statement is given followed by three inferences numbered I, II, and III. Consider the question statement to be true even if it is at variance with the commonly known facts. You have to decide which of the inferences, if any, follow from the given statement.

56. Statement:

One of the major promises made by the BJP government when it came to power in 2014 was to stop tax terrorism.

Inferences:

- I. There is an urgent need in the country to curb black money and corruption.
 - II. One of the primary reasons for the BJP's coming to power was the assurance it gave for curbing tax terrorism.
 - III. The government, vested with power at the center is the only institution, capable enough to tackle problems related to black money and corruption.
- A. Only I
 - B. Only II
 - C. Only III
 - D. All of the above
 - E. None of the above

Direction: A statement is followed by three inferences numbered I, II, and III. Consider the statement to be true even if it is at variance with commonly known facts. You have to decide

which of the inferences, if any, follow from the given statement.

57. Statement: New research suggests that people who drink two to three cups of coffee a day—caffeinated or not—may have a lower chance of dying from certain illnesses than those who abstain.

Inferences:

- I. Drinking coffee is healthy.
 - II. There is a scientific reason why drinking coffee is good for your health.
 - III. People who do not consume coffee are more likely to die sooner than those who drink coffee every day.
- A. Only I follows
 - B. Only II follows
 - C. Only III follows
 - D. Both I and II follow
 - E. All of them follow

58. How many such pairs of letters are there in the word MULTIFARIOUS each of which has as many letters between them (in both forward and backward direction) in the word as in the English alphabet?

- A. Two
- B. Three
- C. Five
- D. Four
- E. None of these

Direction: Study the following information carefully and answer the given questions:

In a family, there are eight members i.e. D, Q, T, U, J, Y, M and P. T is the sister of D. D is married to P. P is the son of M. T is the mother of J. Y is the father of U. Y has only one son and only one daughter. U is the daughter of T. Q is the son of D.

59.

Who among the following is grandfather of Q?

- A. T
- B. U
- C. M
- D. P
- E. None of these

60. What is the relation of Y with respect to J?

- A. Son
- B. Brother
- C. Father
- D. Son in law
- E. None of these

61. Nuakhai Juhar, a harvest festival welcoming the newly harvest crop of the season is celebrated in which state annually?

- A. Odisha
- B. West Bengal
- C. Tripura
- D. Assam
- E. Bihar

62. The INTERPOL has issued a Red Corner Notice (RCN) against fugitive diamond merchant Nirav Modi's brother Nehal in connection with the multi-billion-dollar Punjab National Bank (PNB) scam. Where is the headquarter of the INTERPOL located?

- A. London, UK
- B. Lyon, France
- C. Milan, Italy
- D. Hamburg, Germany
- E. Geneva, Switzerland

63. Vinesh Phogat won the Bronze medal at the Wrestling World Championships held in _____.

- A. China
- B. Kazakhstan
- C. Qatar
- D. Saudi Arabia
- E. UAE

64. International Peace Day is observed every year on which of the following dates?

- A. 19th September
- B. 20th September
- C. 21st September
- D. 22nd September
- E. 23rd September

65. Reserve Bank of India (RBI) had constituted Harsh Vardhan Committee which has submitted its report on September 2019. The committee is related with_____.

- A. Development of Housing Finance Securitization Market
- B. Housing finance securitization market
- C. Excludes non-cash transactions from ATMs from Monthly free transactions
- D. The revision of the current series of Wholesale Price Index
- E. To review the regulatory and supervisory framework for core investment companies

66. _____ state government has decided to set up Swachh Bharat World University to mark the 150th birth anniversary of Mahatma Gandhi.

- A. Madhya Pradesh
- B. Odisha
- C. Uttar Pradesh
- D. Gujarat
- E. Maharashtra

67. The Reserve Bank of India has made mandatory for banks to link retail and MSME loans to an external benchmark rate. This new norm will be effective from_____.

- A. 1st September, 2019
- B. 1st October, 2019
- C. 1st November, 2019
- D. 1st December, 2019
- E. 1st January, 2020

68. Ministry of Labour and Employment recently notified what rate of interest on Provident Fund deposits?

- A. 8.55%
- B. 8.6%
- C. 8.45%
- D. 8.5%
- E. 8.65%

69. 'Pavri Nach' is associated with which state?

- A. Rajasthan
- B. Maharashtra
- C. Gujarat
- D. Mizoram

70. External Commercial borrowings (ECB) can be raised as Capital market instruments e.g. FCEB. In FCEB, E stands for?

- A. External
- B. Efficiency
- C. Exchangeable
- D. Economic
- E. Export

71. Which river is known as the Sorrow of Bihar?

- A. Gandak
- B. Maiti
- C. Son
- D. Kosi
- E. Ghaghra

72. Which bank has inked a bancassurance agreement with Max Bupa Health Insurance to offer health insurance?

- A. Bank of India
- B. Punjab National Bank
- C. State Bank of India
- D. Canara Bank
- E. Indian Bank

73. Who among the following has won the Men's Singles title in the China

Open Badminton Championship 2019?

- A. Anthony Sinisuka Ginting
- B. Kento Momota
- C. Chou Tien-chen
- D. Chen Long
- E. Anders Antonsen

74. Champions Campaign was launched by Delhi government to fight against _____.

- A. measles
- B. dengue
- C. malaria
- D. TB
- E. AIDS

75. Indian Army and Royal Thailand Army (RTA) conducted their joint Military Exercise MAITREE-2019 at _____ from Sept 16-29, 2019.

- A. Nagaland
- B. Meghalaya
- C. Assam
- D. Tripura
- E. Arunachal Pradesh

76. Where is the headquarter of IDFC First Bank located?

- A. Chennai
- B. Bengaluru
- C. Hyderabad
- D. Mumbai
- E. New Delhi

77. Which state's Disaster Management Authority (DMA) has won the IT Excellence Award, 2019?

- A. Maharashtra
- B. Tamil Nadu
- C. Odisha
- D. Uttarakhand
- E. Gujarat

78. Prime Minister Narendra Modi bestowed with the prestigious 'Global Goalkeeper Award'. The award was presented by _____.

- A. Energy and Environment Foundation
- B. Bill and Melinda Gates Foundation
- C. Varkey Foundation
- D. World Health Organization
- E. LEO Foundation

79. Gorumara National Park is located in which state?

- A. Sikkim
- B. Assam
- C. West Bengal
- D. Jharkhand

- E. Madhya Pradesh

80. Kudankulam nuclear power plant is located in which state?

- A. Andhra Pradesh
- B. Telangana
- C. Kerala
- D. Tamil Nadu
- E. Karnataka

###ANSWERS###

1. Ans. C.

Earlier the electronic records were not considered as reliable sources of information in the law, thus actions of cyber crimes had no restriction. There was no way to limit them. This Act was a major step to constrain the activities on the Internet and promote more safety. It declared that materials shared over the Internet would be subject to legal decisions and would be considered as reliable sources of information. Thus option C is the correct answer.

2. Ans. D.

It has been mentioned in the passage that the Act made digital signatures valid and also considered digital transactions more valid and correct. This made certain activities for companies more easy to carry out. Thus, they benefitted a lot when the Act gave these digital activities a proper validation. Option A covers only one aspect. Option D is more generic and thus is the correct answer.

3. Ans. B.

The most dominant positive aspects of the IT act are reflected in E-commerce. Secure electronic transactions in E-commerce will be best facilitated by this Act. It is mentioned in the passage 'From the perspective of e-commerce in India, the IT Act 2000 and its provisions contain many positive aspects'. Thus, all these highlight e-commerce. So, the correct answer is option B.

4. Ans. B.

It is mentioned in the passage, "In view of the growth in transactions and communications carried out through electronic records, the Act seeks to empower government departments to accept filing, creating and retention of official documents in the digital

format". The major reason behind passing this act was the growth of technology everywhere. People communicated and interacted majorly through electronic media so it became extremely necessary to consider all the records and impose laws on them. Thus option B is the correct answer.

5. Ans. A.

It can be inferred from the first paragraph of the given passage that the Act provides security in electronic media and provides the legal framework so that information is not denied legal effect, validity or enforceability, solely on the ground that it is in the form of electronic records. Thus, option A is the correct answer.

6. Ans. B.

There is error in Part (2). The sentence talks about making a choice and not representing any condition to be met here. So, the use of "unless" is incorrect. The correct word here would be "whether".

7. Ans. D.

There is error in Part (4). Here, 'early' should be replaced by 'earlier'. Hence Option D is correct

8. Ans. E.

The sentence is grammatically and contextually correct. So, the correct answer is option E.

9. Ans. C.

The error is in the third part of the sentence.

We need to replace 'publishing' with 'publish'. The to-infinitive structure requires the base form of the verb i.e. 'publish'.

So, the correct answer is option C.

10. Ans. A.

We have to join two parts of a sentence in a way that they form a meaningful and grammatically correct sentence. In the given question B

joins with D and C joins with E to make correct sentences. D tells how the tiny creatures looked like, thus completing B. E tells that nights with darkness has little place in the life we live, thus logically completing C.

Contextually, A and F may join but the sentence will be grammatically incorrect. In (A) 'go' needs to be replaced with 'goes'. Thus, option A is the correct answer.

11. Ans. D.

We have to join two parts of a sentence in a way that they form a meaningful and grammatically correct sentence. In the given question, A joins with F to make a correct sentence and C joins with E to make another correct sentence. F tells who resigned as a legislator, thus completing A. E tells what made laser light possible. In D) article 'a' is incorrect and needs to be replaced with 'an'. Thus, option D is the correct answer.

12. Ans. A.

We have to join two parts of a sentence in a way that they form a meaningful and grammatically correct sentence. In the given question B joins with E and C joins with D to make correct sentences. A-F though looks contextually correct as F talks about the exact location of the bridge that is mentioned in A, but only if the prepositional error were not there in F. The preposition 'at' is incorrect at the beginning and should be replaced by 'over'. B-E makes a grammatically correct and contextually meaningful sentence when joined together. C says that political boundaries should not be barriers and D correctly ends it as the barrier should not be on trade and economic affairs.

Thus, option A is the correct answer.

13. Ans. A.

Here option A is correct as "on" is the preposition that is used to show the physical contact between two objects or one object being supported by (a surface) which is the street in the given sentence.

14. Ans. E.

As there is 'and' present, the subject 'factors' agrees correctly with the verb 'are'. Thus, the given sentence is a general statement and is correct as it is.

15. Ans. A.

When someone uses two or more negative words in a sentence, it's called a double negative. If we use two negative words in a sentence, the sentence conveys a positive meaning which is actually not intended in negative sentences. So, we avoid such situations. 'Unless' means 'if not', so it is incorrect to use another negative (not or none) in a clause with it. It conveys the sense that, to grow you should not try try to do something beyond what you have already mastered, which is in contradiction to the intended meaning. Thus, 'do not' should be removed from the sentence to make it correct. The correct phrase is 'unless you try to'.

16. Ans. C.

As mentioned in the passage, our narrator was never considered fragile, weaker than boys by her parents or her other mentors. But not everyone in the society is blessed with such mentality, that's why our narrator considers herself privileged than most other women in the world. There is a section of population who put restrictions on women's education, outfits, prerogatives. Some men even consider women as mere slaves/ sex slaves. Thus, not all women can afford the same rights of feminism today. But it needs to change.

17. Ans. B.

Feminism, as what it reads doesn't mean putting the women on top of the hierarchy. Neither it is an anti-men movement. The sole idea of feminism is that men and women are equal and they have equal rights in every strata of life. Feminism discourages the idea of differentiation based on the differences of genders. Thus Feminism and Gender quality are inter related.

18. Ans. C.

Feminism is preached wrong. Feminism is not an anti-men movement. It deals with gender equality and discourages the idea of differentiation based on gender differences. Every single human deserves to have equal rights and as the most evolved race it is our responsibility to take care of each other, respect each other and make the world a better place.

19. Ans. A.

Some people still believe in patriarchy and put restrictions on women's education, outfits, prerogatives. So, women instead of being adroit in their respective forte are sometimes neglected. Thankfully, some women are breaking barriers and inspiring others to do so.

20. Ans. B.

Feminism is not an anti-men movement. Sometimes women preach feminism wrong by attacking and mud-slinging men considering feminism a shield of protection. Some people think Feminism is about putting women on the top of the hierarchy. Instead it actually supports gender equality.

21. Ans. D.

The Pattern of series is

$$4 \times 7 - 1 = 27$$

$$27 \times 6 - 2 = 160$$

$$160 \times 5 - 3 = 797$$

$$797 \times 4 - 4 = 3184$$

$$3184 \times 3 - 5 = \mathbf{9547}$$

Hence, option D is the correct answer.

22. Ans. B.

Pattern of the given series is:

$$125 + (12 \times 1) = 137$$

$$137 - 6 = 131$$

$$131 + (12 \times 2) = 155$$

$$155 - 6 = 149$$

$$149 + (12 \times 3) = \mathbf{185}$$

$$185 - 6 = 179$$

$$179 + (12 \times 4) = 227$$

Hence, option B is the correct answer.

23. Ans. D.

Pattern of the given series is:

$$600 \times 0.5 = 300$$

$$300 \times 1.5 = 450$$

$$450 \times 2.5 = 1125$$

$$1125 \times 3.5 = \mathbf{3937.5}$$

Hence, option D is the correct answer.

24. Ans. E.

Pattern of the given series is:

$$5 \times 2 + 1 = 11$$

$$11 \times 4 + 2 = 46$$

$$46 \times 6 + 3 = 279$$

$$279 \times 8 + 4 = \mathbf{2236}$$

Hence, option E is the correct answer.

25. Ans. D.

Statement I:

Let the age of Shabana at the time of marriage = x years

And the age of her husband at the time of marriage = y years

$$\Rightarrow x + y = 50$$

We cannot conclude values of x and y from the above equation.

So, data in statement I alone is not sufficient to answer the question.

Statement II:

Let the age of Shabana = x years

And the age of her daughter = z years

$$\Rightarrow x - z = 25$$

We cannot conclude values of x and z from the above equation.

So, data in statement II alone is not sufficient to answer the question.

Statement III:

At the time of the marriage the age of Shabana = 26 years

So, data in statement III alone is not sufficient to answer the question.

Combining statement I, statement II and statement III:

At the time of the marriage the age of Shabana = 26 years

At the time of the marriage the age of her husband = 24 years

Present age of daughter = a years

So, the data in all the statements I, II and III together is not sufficient to answer the question.

26. Ans. B.

1 hour = 60 minutes

3 hour 30 minutes = 210 minutes

1 hour 24 minutes = 84 minutes

Statements I, II and III alone are not sufficient to answer the question.

Combining statement I and statement II:

Let the total capacity of tank be 420 units.

Number of units of water filled by X $\frac{420}{60}$

and Y together in one minute = $\frac{420}{60} = 7$ units

Number of units of water filled by X $\frac{420}{210}$

and Z together in one minute = $\frac{420}{210} = 2$ units

We cannot calculate the time taken by Pipe Z alone to empty the tank from the above statements.

So, statement I and statement II together are not sufficient to answer the question.

Combining statement II and statement III:

Let the total capacity of tank be 420 units.

Number of units of water filled by X $\frac{420}{210}$

and Z together in one minute = $\frac{420}{210} = 2$ units

Number of units of water filled by X, Y and Z together in one minute = $\frac{420}{84}$

$\frac{420}{84} = 5$ units

We cannot calculate the time taken by Pipe Z alone to empty the tank from the above statements.

So, statement II and statement III together are not sufficient to answer the question.

Combining statement I and statement III:

Let the total capacity of tank be 60 units.

Number of units of water filled by X $\frac{60}{7}$

and Y together in one minute = $\frac{60}{7} = 7$ units

Number of units of water filled by X, Y and Z together in one minute = $\frac{60}{84}$

$\frac{60}{84} = 5$ units

Number of units of water emptied by Z alone in one minute = $7 - 5 = 2$ units

Time taken by Z alone to empty the tank = $\frac{420}{2} = 210$ minutes

So, statement I and statement III together are sufficient to answer the question.

27. Ans. A.

Let the cost price of the product = Rs. 100x

Marked price of the product = Rs. 160x

Let the number of the product = 100y

Selling price of 40% of the products = $40y \times 120x = \text{Rs. } 4800xy$

Selling price of 25% of the remaining products = $15y \times 160x = \text{Rs. } 2400xy$

Selling price of the remaining products = $45y \times 120x = \text{Rs. } 5400xy$

Total selling price of 100y products =
 $4800xy + 2400xy + 5400xy = \text{Rs. } 12600xy$

Total cost price = $10000xy$

Profit = $2600xy$

$$\text{Profit percentage} = \frac{2600xy}{10000xy} \times 100 = 26\%$$

Hence, option A is correct.

28. Ans. B.

Let upstream distance covered by the man be D km.

According to question,

$$\frac{D}{33-7} + \frac{D}{33+7} = 16.5$$

$$\Rightarrow \frac{D}{26} + \frac{D}{40} = 16.5$$

$$\Rightarrow \frac{20D + 13D}{520} = 16.5$$

$$\Rightarrow D = 260 \text{ km}$$

Let the new speed of man in still water be x.

$$\text{So, } \frac{260}{x-7} + \frac{260}{x+7} = \frac{95}{3}$$

$$\Rightarrow 260(x-7+x+7) = \frac{95}{3}(x^2-49)$$

$$\Rightarrow 19x^2 - 312x - 931 = 0$$

$$\Rightarrow x = 19, x = -49/19$$

$$\Rightarrow x = 19 \text{ (because speed is positive)}$$

Hence, option B is the correct answer.

29. Ans. D.

Let the speed of Yash's car = x km/h

Speed of Vansh's car = $1.2x$ km/h

According to the data provided in the question,

$$\frac{150}{1.2x} + 2 = \frac{150}{x}$$

$$\Rightarrow \frac{150}{x} - \frac{150}{1.2x} = 2$$

$$\Rightarrow \frac{150}{x} - \frac{125}{x} = 2$$

$$\Rightarrow \frac{25}{x} = 2$$

$$\Rightarrow x = 12.5$$

Speed of Yash's car = 12.5 km/h

Speed of Vansh's car = $12.5 \times 1.20 = 15$ km/h

Hence, option D is correct.

30. Ans. D.

Let the investment of P and Q be Rs. x and Rs. y respectively.

Ratio of share of profit of P and Q respectively = $(x \times 8 + 2x \times 4) : (y \times 8)$

$$= 16x : 8y$$

Profit of Q = Rs. 3510

Profit of P = $4680 - 3510 = \text{Rs. } 1170$

According to the data provided in the question,

$$\frac{16x}{8y} = \frac{1170}{3510}$$

$$\Rightarrow \frac{x}{y} = \frac{1}{6}$$

$$\text{Required percentage} = \frac{(6-1)}{1} \times 100 = 500\%$$

Hence, option D is correct.

31. Ans. E.

An arithmetic logic unit (ALU) is a digital circuit used to perform arithmetic and logic operations. It represents the fundamental building block of the central processing unit (CPU) of a computer. Modern CPUs contain very powerful and complex ALUs. In addition to ALUs, modern CPUs contain a control unit (CU).

32. Ans. A.

A firewall is a network security system that **monitors** and controls the **incoming** and **outgoing** network traffic based on predetermined security rules.

33. Ans. C.

WAN spans a large geographical area. Often a country or continent. The host are connected by a communication subnet. This subnet consists of 2 distinct components : Transmission lines and switching elements. So, it WAN's the network numerous cables of telephone lines. Each one

connecting a pair of routers if two routers that do not share a cable nevertheless with to communicate they must do this indirectly.

34. Ans. A.

Fifth generation computing devices, based on artificial intelligence, are still in development, though there are some applications, such as voice recognition, that are being used today.

The use of parallel processing and superconductors is helping to make artificial intelligence a reality.

35. Ans. B.

A page has 4 margins – Top, bottom, right and left. These margins can be adjusted according to the user's requirements.

36. Ans. B.

The main purpose of a **primary key** is to implement a relationship between two tables in a **relational database**.

37. Ans. B.

SMTP (Simple Mail Transfer Protocol) is a TCP/IP protocol used in sending and receiving e-mail. However, since it is limited in its ability to queue messages at the receiving end, it is usually used with one of two other protocols, POP3 or IMAP that let the user save messages in a server mailbox and download them periodically from the server. SMTP usually is implemented to operate over Internet **port 25**.

Many mail servers now support **Extended Simple Mail Transfer Protocol** (ESMTP), which allows multimedia files to be delivered as e-mail.

38. Ans. C.

If we want to see all the words **Microsoft Word** thinks you spelled wrong, Press **F7** and you'll jump to them one-by-one.

39. Ans. B.

When your **computer first starts** it will start counting its **memory** in the **top left corner of the screen**. You may see the keyboard lights flash and hear the hard drives spin. Then your computer will beep.

Note:- This process is called the **POST: power on self test**.

40. Ans. B.

A **wildcard** is a symbol used to replace or represent one or more characters.

41. Ans. D.

1) A does not born in a month having 31 days.

Here we have two cases

2) Two people were born between A and H.

3) B was born in a month having less than 31 days.

	Month	People	People
31	January		
28	February	A	B
31	March		H
31	July		
31	August	H	
30	September	B	A
31	October		
31	December		

4) Number of people were born before B is same as number of people were born after G.

5) Only one person was born between G and C.

	Month	People	People
31	January	C	
28	February	A	B
31	March	G	H
31	July		
31	August	H	C
30	September	B	A
31	October		G
31	December		

6) Two people were born between C and D.

7) E was born before F but not on October.

	Month	People
31	January	E
28	February	B
31	March	H
31	July	F
31	August	C
30	September	A
31	October	G
31	December	D

Clearly, no one born after D.

42. Ans. B.

1) A does not born in a month having 31 days.

Here we have two cases

2) Two people were born between A and H.

3) B was born in a month having less than 31 days.

	Month	People	People
31	January		
28	February	A	B
31	March		H
31	July		
31	August	H	
30	September	B	A
31	October		
31	December		

4) Number of people were born before B is same as number of people were born after G.

5) Only one person was born between G and C.

	Month	People	People
31	January	C	
28	February	A	B
31	March	G	H
31	July		
31	August	H	C
30	September	B	A
31	October		G
31	December		

6) Two people were born between C and D.

7) E was born before F but not on October.

	Month	People
31	January	E
28	February	B
31	March	H
31	July	F
31	August	C
30	September	A
31	October	G
31	December	D

Clearly, E was born in January.

43. Ans. B.

1) A does not born in a month having 31 days.

Here we have two cases

2) Two people were born between A and H.

3) B was born in a month having less than 31 days.

	Month	People	People
31	January		
28	February	A	B
31	March		H
31	July		
31	August	H	
30	September	B	A
31	October		
31	December		

4) Number of people were born before B is same as number of people were born after G.

5) Only one person was born between G and C.

	Month	People	People
31	January	C	
28	February	A	B
31	March	G	H
31	July		
31	August	H	C
30	September	B	A
31	October		G
31	December		

6) Two people were born between C and D.

7) E was born before F but not on October.

	Month	People
31	January	E
28	February	B
31	March	H
31	July	F
31	August	C
30	September	A
31	October	G
31	December	D

Clearly, one person was born between H and C.

44. Ans. C.

1) A does not born in a month having 31 days.

Here we have two cases

2) Two people were born between A and H.

3) B was born in a month having less than 31 days.

	Month	People	People
31	January		
28	February	A	B
31	March		H
31	July		
31	August	H	
30	September	B	A
31	October		
31	December		

4) Number of people were born before B is same as number of people were born after G.

5) Only one person was born between G and C.

	Month	People	People
31	January	C	
28	February	A	B
31	March	G	H
31	July		
31	August	H	C
30	September	B	A
31	October		G
31	December		

6) Two people were born between C and D.

7) E was born before F but not on October.

	Month	People
31	January	E
28	February	B
31	March	H
31	July	F
31	August	C
30	September	A
31	October	G
31	December	D

Clearly, G was born in October.

45. Ans. C.

1) A does not born in a month having 31 days.

Here we have two cases

2) Two people were born between A and H.

3) B was born in a month having less than 31 days.

	Month	People	People
31	January		
28	February	A	B
31	March		H
31	July		
31	August	H	
30	September	B	A
31	October		
31	December		

4) Number of people were born before B is same as number of people were born after G.

5) Only one person was born between G and C.

	Month	People	People
31	January	C	
28	February	A	B
31	March	G	H
31	July		
31	August	H	C
30	September	B	A
31	October		G
31	December		

6) Two people were born between C and D.

7) E was born before F but not on October.

	Month	People
31	January	E
28	February	B
31	March	H
31	July	F
31	August	C
30	September	A
31	October	G
31	December	D

Clearly, three people were born before F.

46. Ans. A.

- 1) No one sits to the right of I.
- 2) C sits exactly in the middle of the row.
- 3) D does not sit adjacent to neither C nor I.
- 4) D is fourth to the right of F.

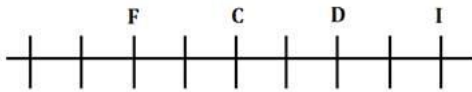

5) G and H are sitting next to each other.

6) H does not sit at any extreme end.

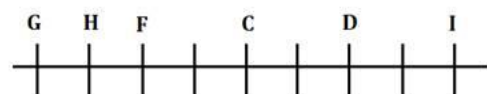

- 7) A is second to the right of H.
- 8) E is the neighbour of D but not of C.

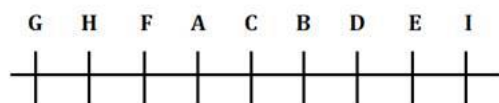

Clearly, B sits third to the right of F.

47. Ans. C.

- 1) No one sits to the right of I.
- 2) C sits exactly in the middle of the row.
- 3) D does not sit adjacent to neither C nor I.
- 4) D is fourth to the right of F.

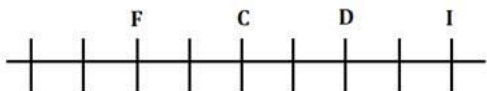

5) G and H are sitting next to each other.

6) H does not sit at any extreme end.

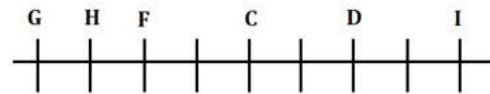

- 7) A is second to the right of H.
- 8) E is the neighbour of D but not of C.

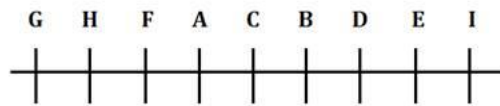

Clearly, two people sit between B and I.

48. Ans. A.

- 1) No one sits to the right of I.
- 2) C sits exactly in the middle of the row.
- 3) D does not sit adjacent to neither C nor I.
- 4) D is fourth to the right of F.

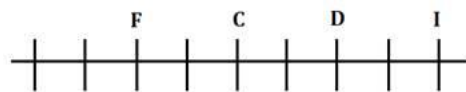

5) G and H are sitting next to each other.

6) H does not sit at any extreme end.

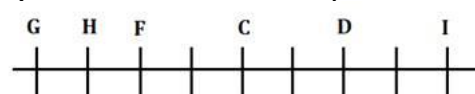

- 7) A is second to the right of H.
- 8) E is the neighbour of D but not of C.

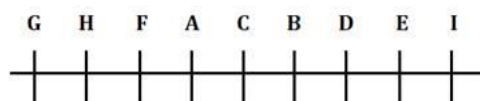

Clearly, four people sit to the left of C.

49. Ans. B.

- 1) No one sits to the right of I.
- 2) C sits exactly in the middle of the row.
- 3) D does not sit adjacent to neither C nor I.
- 4) D is fourth to the right of F.

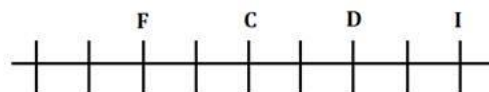

5) G and H are sitting next to each other.

6) H does not sit at any extreme end.

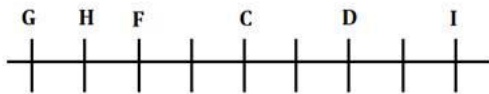

7) A is second to the right of H.

8) E is the neighbour of D but not of C.

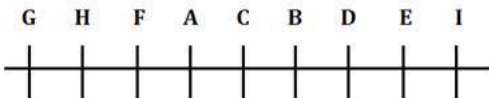

Clearly, A sits exactly between H and B.

50. Ans. E.

1) No one sits to the right of I.

2) C sits exactly in the middle of the row.

3) D does not sit adjacent to neither C nor I.

4) D is fourth to the right of F.

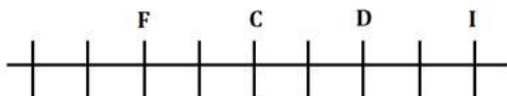

5) G and H are sitting next to each other.

6) H does not sit at any extreme end.

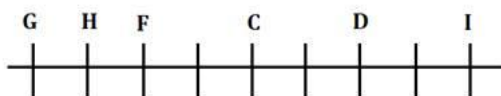

7) A is second to the right of H.

8) E is the neighbour of D but not of C.

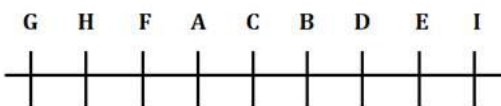

Clearly, four people sit between E and F.

51. Ans. B.

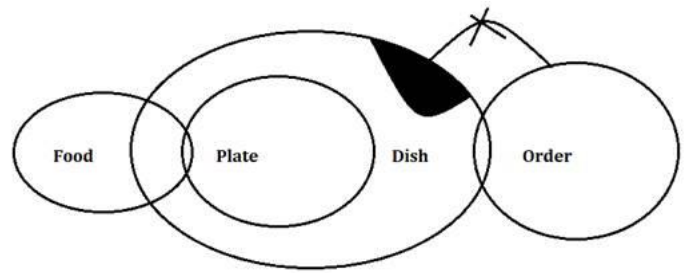

Clearly, only II follows.

52. Ans. E.

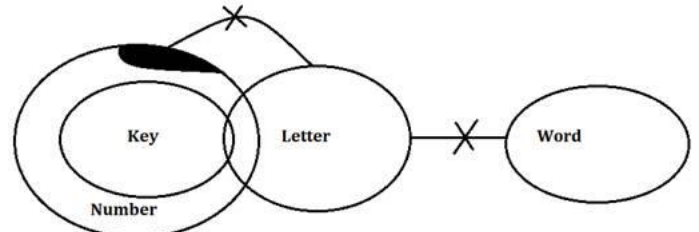

Clearly, both follow.

53. Ans. A.

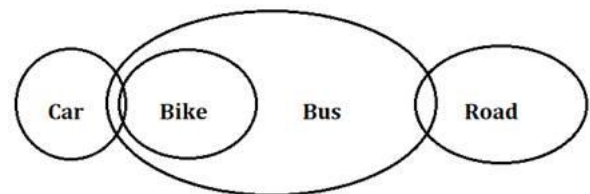

Conclusions:

I. Some Road being Bike is a possibility – It's true as no relation between them so it is possible.

II. All Car can never be Bus – All car can be bus so it's false.

Clearly, only I follow.

54. Ans. D.

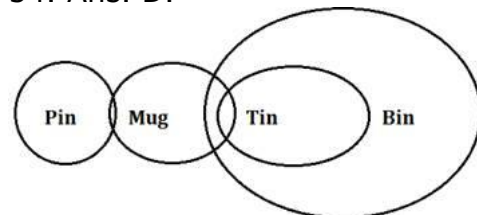

Conclusions:

I. Some Pin is Tin – It's false as there is no direct relation.

II. All Mug is Bin. – It's false as there is no direct relation.

Clearly, neither I nor II follows.

55. Ans. A.

Only inference I follows. The statement clearly says that Swift has

logged a hundred thousand bookings in the shortest time, from which we can infer that it is the most sought after, or in other words, the most popular car right now.

Both inferences II and III contain extraneous information and cannot be concluded from what is given. Therefore, option A is the correct answer.

56. Ans. E.

The term tax terrorism and black money and corruption are not interrelated. This is the trick here. A lot of us would draw parallels between the two concepts and end of marking the incorrect answer. Tax terrorism' refers to the use of tax laws and legal machinery by the state to create inconvenience for entrepreneurs. Black money and corruption may be one of the outcomes of tax terrorism if people start evading such taxes.

Thus, statements I and III are definitely not the inferences that we can base on the given statement. Statement II talks about one of the reasons for the BJP coming to power. The question statement, however, tells us that this was one of the promises made by the party and hence can not be the reason. Thus, none of them can be inferred and option E is the correct answer.

57. Ans. D.

Both inferences I and II follow. The given statement tells us that according to a new research, people who drink coffee everyday may have a lower chance of dying from certain illnesses in comparison to those who do not drink coffee. From here, we can clearly infer that there are scientific reasons to prove that coffee is healthy. Inference III does not follow because the statement makes no comment on people who do not drink coffee. Further, it is also

mentioned in the statement that drinking coffee might help only in the case of certain illnesses. Hence, we cannot infer if not drinking coffee makes you die sooner than those who have coffee daily. Therefore, option D is the correct answer.

58. Ans. B.

Given word: MULTIFARIOUS





The given word can be represented as follows:

Letters	M	U	L	T	I	F	A	R	I	O	U	S
Position	13	21	12	20	9	6	1	18	9	15	21	19

Thus, there are 3 such pairs – FI, IM and RU.

Hence, three is the correct answer.

59. Ans. E.

Symbol in diagram	Meaning
	Female
	Male
	Married Couple
	Siblings
	Difference of a generation

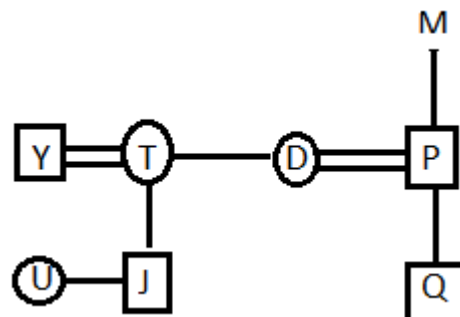

Hence, we cannot say as we do not know the gender of M.

60. Ans. C.

Symbol in diagram	Meaning
○	Female
□	Male
==	Married Couple
—	Siblings
	Difference of a generation

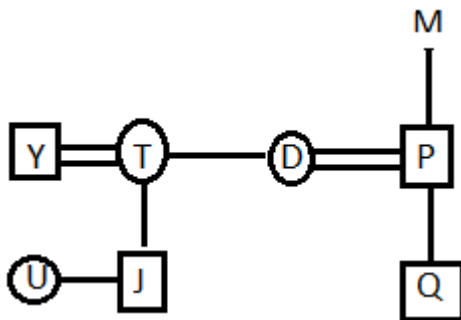

Hence, Y is father of J.

61. Ans. A.

- Nuakhai Juhar, a harvest festival welcoming the newly harvest crop of the season was celebrated in Odisha.
- It is one of the most ancient festivals celebrated in Odisha to welcome new crop of the season. It is an important social festival of Western Odisha and is an agricultural festival.

62. Ans. B.

- The International Criminal Police Organization (INTERPOL) is an intergovernmental organization that helps coordinate the police force of 194 member countries.
- Each of the member countries hosts an INTERPOL National Central Bureau (NCB). This connects their national law enforcement with other countries and with the General Secretariat.

- The Central Bureau of Investigation (CBI) is designated as the National Central Bureau of India.

- The General Secretariat provides a range of expertise and services to the member countries.

- It is headquartered in Lyon, France.
63. Ans. B.

- Vinesh Phogat won the Bronze medal at the Wrestling World Championships held in Nur-Sultan, Kazakhstan by defeating Maria Prevolaraki of Greece in 53 kg freestyle event.

- She is only the fourth Indian female wrestler to win a medal at the Wrestling World Championships

64. Ans. C.

- International Peace Day is observed every year on September 21. It's a day to work towards global harmony and world peace.

- This year, the theme for World Peace Day is "Climate Action For Peace".

- The International Peace Day was first recognised by the United Nations in 1982.

65. Ans. A.

- Reserve Bank of India has set up a six member committee headed by Harsh Vardhan to suggest measures to make the housing finance securitization market more attractive has recommended to set up an intermediary under the National Housing Bank (NHB) with 51% government ownership.

- The panel says the intermediary could operate either directly through the NHB, the Indian Mortgage Guarantee Corp., or the RBI could set up a new organisation

- The panel also suggest to link pricing of all loans to an external benchmark as the current Marginal

Cost of Funds Based Lending Rate (MCLR) may not be comparable across banks.

- Also recommended setting up of an online loan sales platform to conduct auctions of secondary market loans.

- NHB is wholly owned by Govt. of India Headquartered in Mumbai

66. Ans. E.

- Maharashtra state government has decided to set up Swachh Bharat World University to mark the 150th birth anniversary of Mahatma Gandhi.

- It will focus on research studies in sanitation, cleanliness and environment.

- The State has formed a seven-member committee headed by the Minister of Education Vinod Tawde.

- The committee will conduct a study on the requirements of the University, including land, basic infrastructure and manpower and submit a report in two months.

67. Ans. B.

- The Reserve Bank of India has made mandatory for banks to link retail and MSME loans to external benchmark rates.

- This new norm will be effective from the **1st of October**. Under this norm, banks have to link all of their new loan products, be it personal, housing or auto to an external benchmark rate.

- Banks have been allowed to choose any benchmark market interest rate published by the Financial Benchmarks India Private Ltd (FBIL).

- Banks can choose RBI's repo rate, government of India's three-month treasury bill yield published by the FBIL, government's six-month treasury bill yield published by the FBIL or any other market interest rate published by the FBIL.

68. Ans. E.

- Ministry of Labour and Employment notified 8.65% rate of interest on

Provident Fund deposits for its over 6 crore subscribers.

- Interest rate, approved for 2017-18 was 8.55%.

69. Ans. B.

- **Pavri Nach** is a dance is associated with **Maharashtra**.

- It is performed by the **Kokna tribe** in the hilly regions of northwest Maharashtra and adjoining region of Gujarat in India.

- The dance is also known as '**Tarpha Nach**'.

- This dance is performed both by males and females.

70. Ans. C.

FCEB stands for Foreign Currency Exchangeable Bonds. FCEB bonds are expressed in Foreign currency and their principal and interest is also payable in foreign currency.

71. Ans. D.

- The Kosi River is known as the "Sorrow of Bihar" as the annual floods affect about 21,000 km sq (8,100 sq mi) of fertile agricultural lands thereby disturbing the rural economy.

- Bihar's economy is mainly based on Farming and Kosi River ruins it during floods as well as claims many thousand of life of Human & Cattle.

72. Ans. E.

- Indian Bank has inked a bancassurance agreement with Max Bupa Health Insurance to offer health insurance.

- It will offer both retail and group health insurance products besides indemnity and fixed benefit products.

73. Ans. B.

- Kento Momota (Japan) has won the China Open Badminton Title 2019.

- The 2019 China Open badminton tournament took place at Olympic Sports Center Xincheng Gymnasium

in Changzhou, Jiangsu, China (17 to 22 September 2019).

- This tournament was organized by the Chinese Badminton Association and sanctioned by the BWF.
- Carolina Marina (Spain) won the Women's Single title in China Open Badminton Championship 2019.

74. Ans. B.

- Champions Campaign was launched by the Delhi government to fight against dengue.
- It will encourage people to refer at least 10 of their friends to check homes for clean stagnant water every Sunday for 10 minutes.

75. Ans. B.

- The 2019 edition of Maitree, the joint military exercise between India and Thailand will be conducted from 16-29 September at Foreign Training Node, Umroi, in Meghalaya.
- Exercise MAITREE is a joint military exercise which is being conducted between armies of India and Thailand since 2006. This annual training event is held alternatively in Thailand and India.
- Aim of Military Exercise is to share experience gained during various counter-terrorism operations.

76. Ans. D.

- IDFC First Bank (formerly IDFC Bank) is an Indian banking company with headquarters in Mumbai that forms part of IDFC, an integrated infrastructure finance company.
- The bank started operations on 1 October 2015. IDFC received a universal banking licence from the Reserve Bank of India (RBI) in July 2015.

77. Ans. C.

- Odisha State Disaster Management Authority (OSDMA) has won the IT Excellence Award, 2019.
- The award was presented to the Odisha state for its innovative

conception by using information technology in the field of disaster management.

- The "SATARK" (System for Assessing, Tracking and Alerting Disaster Risk Information based on Dynamic Risk Knowledge) has been chosen for the award

78. Ans. B.

- Prime Minister Narendra Modi has been honoured with the prestigious 'Global Goalkeeper Award'. He bestowed with this honour for his commitment and leadership towards Swachh Bharat Abhiyan.
- The award will be presented by the Bill and Melinda Gates Foundation which is owned by Microsoft founder Bill Gates and his wife Melinda Gates.
- The Global Goalkeeper Awards are presented to leaders and individuals for their efforts in achieving the Sustainable Development Goals (SDGs) in five categories.
- The categories are Progress, Changemaker, Campaign, Goalkeepers Voice and the Global Goalkeeper.

79. Ans. C.

- Gorumara National Park is a National Park in northern West Bengal, India.
- Located in the Dooars region of the Himalayan foothills, it is a medium-sized park with grasslands and forests.
- It is primarily known for its population of Indian rhinoceros
- It is situated on the banks of rivers Murti and Raidak in the Jalpaiguri district of West Bengal.

80. Ans. D.

- Kudankulam nuclear power plant was in news because some said that the plant was hacked.
- Kudankulam Nuclear Power Plant's (KKNPP) Site Director Sanjay Kumar said the totally isolated network of

KKNPP could not be accessed by any outside network from any part of the globe.

- Hence, there was no question of it being hacked.